

Texas Department of Transportation  
Technical Provisions  
for  
SH 249 Extension

Attachment 2-1  
Work Breakdown Structure Requirements

February 9, 2017

The Project Baseline Schedule shall be organized consistent with the WBS shown in Table 1. Additional WBS elements and levels may be added with TxDOT's approval

The Schedule of Values shall be the rollup of all Payment Activities to the WBS Level 3, 4, or 5 as appropriate.

**Table 1: WBS Minimum Requirements**

- 1 [Name of Project]**
  - 1.1. Project Administration**
    - 1.1.1. Mobilization
      - 1.1.1.1. (by DB Contractor entity)
    - 1.1.2. Administrative Submittals and Permitting
      - 1.1.2.1. (By Governmental Agency)
        - 1.1.2.1.1. (By Specific Permit/Submittal Requirement)
  - 1.2. Right of Way Acquisition**
    - 1.2.1. Acquisition By TxDOT
      - 1.2.1.1. (By Parcel No.)
    - 1.2.2. Acquisition by DB Contractor
      - 1.2.2.1. (By Parcel No.)
  - 1.3. Utility Adjustments**
    - 1.3.1. Utility Coordination
      - 1.3.1.1. Administration and Planning
        - 1.3.1.1.1. Site Utility Engineering
        - 1.3.1.1.2. Conceptual Design
      - 1.3.1.2. (By Owner)
        - 1.3.1.2.1. Master Agreements
        - 1.3.1.2.2. Utility Assemblies
    - 1.3.2. Utility Relocations
      - 1.3.2.1. (By Owner)
        - 1.3.2.1.1. (By Line No.)
  - 1.4. Design**
    - 1.4.1. General Activities and Field Work
      - 1.4.1.1. Design Mobilization
      - 1.4.1.2. Schematics
      - 1.4.1.3. Survey Work
      - 1.4.1.4. Geotechnical Investigations
      - 1.4.1.5. Additional Field Investigations
    - 1.4.2. Develop Specifications
      - 1.4.2.1. (By Discipline)
    - 1.4.3. Geotechnical Design
      - 1.4.3.1. General
      - 1.4.3.2. Earthwork Geotech
      - 1.4.3.3. Bridge Geotech
      - 1.4.3.4. Culvert Geotech
      - 1.4.3.5. Wall Geotech
    - 1.4.4. Pavement Design
      - 1.4.4.1. Data Analysis and Draft Report
      - 1.4.4.2. Final Design and Report

## **1.4. Design (Continued)**

- 1.4.5. Drainage Design
  - 1.4.5.1. Hydrologic and Hydraulic Design
  - 1.4.5.2. Preliminary System Design
  - 1.4.5.3. Detailed Drainage Design
- 1.4.6. Roadway Design
  - 1.4.6.1. Alignments
  - 1.4.6.2. Sections
  - 1.4.6.3. Detailed Design
- 1.4.7. Bridge Design
  - 1.4.7.1. Establish Criteria and Procedures
  - 1.4.7.2. Bridge layouts
  - 1.4.7.3. Substructure Design
  - 1.4.7.4. Superstructure Design
- 1.4.8. Retaining Wall Design
  - 1.4.8.1. Establish Criteria and Procedures
  - 1.4.8.2. Fill Wall Design
  - 1.4.8.3. Cut Wall Design
- 1.4.9. Traffic Management
  - 1.4.9.1. (By Phase)
- 1.4.10. Environmental Design
  - 1.4.10.1. Erosion Control/SWPPP
  - 1.4.10.2. Noise Wall Design
  - 1.4.10.3. Wetland and habitat Mitigation
  - 1.4.10.4. TCEQ Best Management Practices
- 1.4.11. Landscape and Aesthetic Design
  - 1.4.11.1. Landscape Design
  - 1.4.11.2. Aesthetic Design
- 1.4.12. Electrical Design
  - 1.4.12.1. Illumination
  - 1.4.12.2. Traffic Signals
- 1.4.13. ITS & TCS Design
  - 1.4.13.1. Duct Bank System & Power Supply
  - 1.4.13.2. ITS/TCS Equipment & Structures
- 1.4.14. Signage and Marking Design
  - 1.4.14.1. Overhead
  - 1.4.14.2. Small signs and pavement markings
- 1.4.15. Design Packages
  - 1.4.15.1. Package Preparation
  - 1.4.15.2. QA/QC Review
  - 1.4.15.3. Submittal
  - 1.4.15.4. TxDOT/IE Reviews
  - 1.4.15.5. Comment Resolution

## **1.5. Construction**

- 1.5.1. General
- 1.5.2. Material Submittals, Procurement and Long-lead Items
- 1.5.3. Mobilization
- 1.5.4. Administration
- 1.5.5. Quality Control

## **1.5. Construction (Continued)**

### 1.5.6. By Phase or Work Area

#### 1.5.6.1. Removals

- 1.5.6.1.1. Building Removals
- 1.5.6.1.2. ROW Preparation
- 1.5.6.1.3. Roadway Removals
- 1.5.6.1.4. Bridge Removals

#### 1.5.6.2. Earthwork

- 1.5.6.2.1. Topsoil Stripping and Placing
- 1.5.6.2.2. Excavation
- 1.5.6.2.3. Embankment
- 1.5.6.2.4. Special Geotechnical Measures

#### 1.5.6.3. Landscaping

- 1.5.6.3.1. Seeding and Sodding
- 1.5.6.3.2. Fertilizer and Watering
- 1.5.6.3.3. Special Aesthetic Landscaping (if applicable)

#### 1.5.6.4. Subgrade Treatment and Base

- 1.5.6.4.1. Lime Treatment
- 1.5.6.4.2. Flexible Base

#### 1.5.6.5. Pavement

- 1.5.6.5.1. Asphalt Pavement
- 1.5.6.5.2. Concrete Pavement
- 1.5.6.5.3. Curb & Gutter
- 1.5.6.5.4. Driveways
- 1.5.6.5.5. Sidewalks and Median Paving

#### 1.5.6.6. Retaining Walls

- 1.5.6.6.1. (By Wall No.)

#### 1.5.6.7. Bridges

- 1.5.6.7.1. (By Bridge No.)

#### 1.5.6.8. Drainage

- 1.5.6.8.1. Culverts
- 1.5.6.8.2. Storm Sewer
- 1.5.6.8.3. Riprap

#### 1.5.6.9. Traffic Control and Temporary Work

- 1.5.6.9.1. Barricades, Signs & Traffic Handling
- 1.5.6.9.2. Erosion Control
- 1.5.6.9.3. Detour Construction/Removal
- 1.5.6.9.4. Portable Traffic Barrier
- 1.5.6.9.5. Workzone Pavement Marking
- 1.5.6.9.6. Temporary Bridges
- 1.5.6.9.7. Temporary Walls/Shoring
- 1.5.6.9.8. Temporary Drainage
- 1.5.6.9.9. Temporary Illumination

#### 1.5.6.10. Permanent Barriers

- 1.5.6.10.1. Permanent Concrete Barriers
- 1.5.6.10.2. Metal Beam Guard Fence
- 1.5.6.10.3. Crash Attenuators

## **1.5. Construction (Continued)**

- 1.5.6.11. Signals and Illumination
  - 1.5.6.11.1. Roadway Illumination
  - 1.5.6.11.2. High Mast Illumination
  - 1.5.6.11.3. Electrical Services
  - 1.5.6.11.4. Traffic Signals
- 1.5.6.12. ITS/TCS
  - 1.5.6.12.1. Duct Bank System
  - 1.5.6.12.2. Equipment Foundations
  - 1.5.6.12.3. Support Structures and Equipment
- 1.5.6.13. Permanent Signing and Marking
  - 1.5.6.13.1. Overhead Sign Structures
  - 1.5.6.13.2. Small Signs
  - 1.5.6.13.3. Pavement Markings
- 1.5.6.14. Environmental Mitigation
  - 1.5.6.14.1. Noise Walls
  - 1.5.6.14.2. Wetland and Habitat Mitigation
- 1.5.6.15. Hazardous Materials
  - 1.5.6.15.1. Site Assessments
  - 1.5.6.15.2. Remediation

## **1.6. Close-out**

- 1.6.1. Inspections
- 1.6.2. Punch List
- 1.6.3. Closing Documentation
  - 1.6.3.1. Record Documents
  - 1.6.3.2. Maintenance Records
  - 1.6.3.3. Warranty Documents
- 1.6.4. Substantial Completion
- 1.6.5. Final Acceptance

Texas Department of Transportation  
Technical Provisions  
for  
SH 249 Extension

Attachment 4-1  
Environmental Permits, Issues and Commitments

February 9, 2017

**ENDANGERED SPECIES/WILDLIFE:**

DO NOT DISTURB OR HARM ENDANGERED SPECIES AND/OR THEIR HABITAT IF LISTED BELOW. VERIFY EXISTENCE OF HABITAT WITH AREA ENGINEER BEFORE CLEARING TREES. MINIMIZE DISTURBANCE TO AREA WILDLIFE

BRIDGE/CULVERT WORK REQUIRES INSPECTION FOR NESTING BIRDS BY ENV PERSONNEL PRIOR TO WORK

SPECIES IN PROJECT AREA      HABITAT      SPECIAL NOTES  
 DB CONTRACTOR SHALL EVALUATE FOR SENSITIVE SPECIES AND HABITAT CONCERNS BASED ON FINAL DESIGN AND ANY DESIGN CHANGES.

**COMMENTS**

DB CONTRACTOR SHALL COMPLY WITH ALL FEDERAL & STATE LAWS RELATED TO THREATENED & ENDANGERED SPECIES. DB CONTRACTOR SHALL BE RESPONSIBLE FOR COMPLETING ON-SITE STATE AND FEDERAL THREATENED AND ENDANGERED SPECIES FIELD INVESTIGATIONS WITHIN PROJECT ROW PRIOR TO CONSTRUCTION. DB CONTRACTOR SHALL PREPARE ALL MATERIALS FOR COORDINATION. DB CONTRACTOR SHALL BE RESPONSIBLE FOR IMPLEMENTING ALL MITIGATION AND BEST MANAGEMENT PRACTICES IDENTIFIED DURING COORDINATION. DB CONTRACTOR SHALL BE RESPONSIBLE FOR PERFORMING NECESSARY THREATENED & ENDANGERED SPECIES SURVEYS & IMPLEMENTING ALL BMPs & MITIGATION REQUIREMENTS PER FINAL DESIGN AND ANY DESIGN CHANGES.

SHOULD A LISTED SPECIES BE IDENTIFIED WITHIN THE PROJECT ROW DURING CONSTRUCTION, DB CONTRACTOR SHALL COORDINATE WITH TxDOT, USFWS, & TPWD TO DEVELOP SPECIES SPECIFIC MITIGATION STRATEGIES TO AVOID, MINIMIZE AND/OR COMPENSATE FOR POTENTIAL IMPACTS TO THREATENED OR ENDANGERED SPECIES.

**CULTURAL RESOURCES (HISTORICAL/ARCHEOLOGICAL):**

KNOWN ITEMS OF HIST/ARCHEOLOGICAL INTEREST IN PROJECT AREA :

- BUILDINGS
- BRIDGES
- CEMETERIES
- ARCHEOLOGICAL SITES
- HISTORIC MARKERS/PLAQUES
- OTHER

IF ADDITIONAL HISTORICAL OR ARCHEOLOGICAL SITES ARE DISCOVERED DURING CONSTRUCTION IMMEDIATELY NOTIFY AREA ENGINEER AND THE DISTRICT ENVIRONMENTAL SECTION.

**CULTURAL RESOURCE AREAS OF CONCERN**

Station Number - Lt./Rt. (C/L or B/L)      Commitment/Avoidance

THE ARCHEOLOGICAL SURVEY REPORT IDENTIFIED FOUR ARCHEOLOGICAL SITES WITHIN THE APE. DETERMINATION OF THE NHRP AND SAL DESIGNATION ELIGIBILITY OF THESE SITES IS PENDING DB CONTRACTOR'S COMPLETION OF THE SURVEY AND FURTHER COORDINATION WITH APPLICABLE AGENCIES. DB CONTRACTOR SHALL EVALUATE FOR ANY ARCHEOLOGICAL AREAS OF CONCERN BASED ON FINAL DESIGN AND ANY DESIGN CHANGES.

**COMMENTS**

DB CONTRACTOR WILL BE RESPONSIBLE FOR COMPLETING ARCHEOLOGICAL SURVEYS (AS REQUIRED BY THC) WITHIN PROJECT ROW FOR THOSE AREAS THAT WERE NOT PREVIOUSLY SURVEYED AS PART OF THE FEIS/ROD. BASED ON DB CONTRACTOR'S FIELD INVESTIGATIONS, DB CONTRACTOR SHALL PREPARE ALL REQUIRED DOCUMENTATION AND SUBMIT TO TxDOT FOR REVIEW, ACCEPTANCE, AND FURTHER COORDINATION. DB CONTRACTOR SHALL IMPLEMENT ALL MITIGATION REQUIREMENTS IDENTIFIED DURING AGENCY COORDINATION. DB CONTRACTOR SHALL BE RESPONSIBLE FOR PERFORMING ANY ADDITIONAL CULTURAL RESOURCE SURVEYS PER THE FINAL DESIGN AND ANY DESIGN CHANGES. DB CONTRACTOR WILL BE RESPONSIBLE FOR COMPLETING HISTORIC SURVEYS PER THC FOR THE FINAL DESIGN AND ANY DESIGN CHANGES.

**NOISE:**

NOISE LEVELS IN RESIDENTIAL AREAS AND OTHER SENSITIVE AREAS SHOULD NOT EXCEED THE MAXIMUM ALLOWABLE FOR DAY/NIGHT AS SHOWN IN THE GENERAL NOTES OR AS DIRECTED BY THE ENGINEER, AVOID ROUTING OF CONSTRUCTION EQUIPMENT THROUGH RESIDENTIAL OR SENSITIVE AREAS IF LISTED BELOW.

**COMMENTS**

DB CONTRACTOR SHALL MAKE EVERY REASONABLE EFFORT TO MINIMIZE CONSTRUCTION NOISE. DB CONTRACTOR SHALL PROVIDE ALL REQUIRED NOISE ABATEMENT MEASURES. DB CONTRACTOR MAY BE REQUIRED TO REASSESS NOISE IMPACTS AND ABATEMENT MEASURES PER THE FINAL DESIGN AND ANY DESIGN CHANGES. DB CONTRACTOR SHALL PERFORM ALL PUBLIC INVOLVEMENT REQUIREMENTS AND UTILITY EVALUATIONS ASSOCIATED WITH THE IMPLEMENTATION OF NOISE ABATEMENT MEASURES. DB CONTRACTOR SHALL COORDINATE WITH TxDOT ENV STAFF TO GAIN ACCEPTANCE OF ALL NOISE RELATED SUBMITTALS AND EVENTS.

**SOUNDWALLS:**

DO NOT LEAVE GAPS BETWEEN PANELS OR POSTS IN NOISE WALLS. IF NEOPRENE PADS ARE REQUIRED, ENSURE THAT THEY ARE PLACED BETWEEN PANELS. DO NOT DAMAGE OR CAUSE EROSION TO ADJACENT PROPERTIES. ENSURE COLOR CONTINUITY FOR CONCRETE MIX THROUGHOUT CONSTRUCTION.

**COMMENTS**

DB CONTRACTOR WILL BE RESPONSIBLE TO BUILD THE PROPOSED NOISE WALL IN ACCORDANCE W/ TxDOT STANDARDS AND THE REQUIRED NOISE WORKSHOP(S). DB CONTRACTOR SHALL REASSESS NOISE IMPACTS & ABATEMENT MEASURES PER THE FINAL DESIGN AND ANY DESIGN CHANGES DIFFERING FROM THE FEIS/ROD. THE PROJECT WILL FOLLOW TxDOT GREEN RIBBON STANDARDS.

**ENVIRONMENTAL ISSUES**

SEGMENT 1

**WATER QUALITY:**

- REFER TO STORMWATER POLLUTION PREVENTION PLAN SHEET
- MINIMIZE SEDIMENT RUNOFF
- MINIMIZE POLLUTION
- CONTAIN & PROPERLY DISPOSE OF POTENTIALLY HAZARDOUS SUBSTANCES.
- ALL WORK SHOULD BE PERFORMED ACCORDING TO ALL APPLICABLE STATUTES.

**COMMENTS**

THE PROPOSED PROJECT WOULD DISTURB MORE THAN 5 ACRES. THE DB CONTRACTOR MUST COMPLY WITH THE TPDES CONSTRUCTION GENERAL PERMIT. DB CONTRACTOR MUST SUBMIT A NOI TO TCEQ AND POST A COPY AT THE CONSTRUCTION SITE. DB CONTRACTOR MUST IMPLEMENT & MAINTAIN A SW3P THROUGHOUT CONSTRUCTION, AS WELL AS SUBMIT AN NOI TO TCEQ AND A NOTICE OF TERMINATION ONCE THE SITE HAS REACHED FINAL STABILIZATION. DB CONTRACTOR MUST COMPLY WITH APPLICABLE MS4 REQUIREMENTS.

**WETLANDS/WATERS OF U.S.:**

NO FILLING, DREDGING OR EXCAVATING IN ANY WATERBODIES, RIVERS, CREEKS, STREAMS OR WET AREAS UNLESS SPECIFICALLY ALLOWED IN UNITED STATES CORPS OF ENGINEERS PERMIT OR APPROVED BY AREA ENGINEER. CONTRACTOR MUST OBTAIN ANY PERMIT FOR TEMPORARY FILL DUE TO CONSTRUCTION METHODS OTHER THAN THOSE SPECIFIED IN PLANS. CONTRACTOR MUST COORDINATE ANY PERMITS WITH THE TxDOT DISTRICT ENVIRONMENTAL SECTION. DO NOT REMOVE AND PLACE ANY FILL MATERIAL, CONSTRUCTION DEBRIS, ETC. ON ADJACENT OR OTHER PROPERTIES WITHOUT PRIOR PERMISSION OF AREA ENGINEER.

- U.S. CORPS OF ENGINEERS PERMIT      INDIVIDUAL PERMIT SWG-2014-00727
- U.S. COAST GUARD PERMIT      ADDENDUM TO IP SWG-2014-00727
- BRIDGE/WATERWAY LOCATION
- KEEP BRIDGE CLEARANCE SAME AS EXISTING

**CONTRACTOR MUST NOTIFY:**

- Must notify MS4 Operator(s) of discharges from this project
- U.S. COAST GUARD 30 DAYS PRIOR TO BEGINNING CONSTRUCTION
- DISTRICT ENVIRONMENTAL SECTION PRIOR TO BEGINNING CONSTRUCTION
- U.S. COAST GUARD 2 WEEKS PRIOR TO CHANNEL CLOSURES
- U.S. COAST GUARD 1 WEEK PRIOR TO CHANNEL CLOSURES
- U.S. COAST GUARD 48 HRS PRIOR TO CHANNEL CLOSURES
- Coordination with Floodplains Administrator required.

**COMMENTS**

DB CONTRACTOR SHALL COMPLY WITH THE APPROVED INDIVIDUAL PERMIT (SWG-2014-00727) & ANY AMENDMENTS OR ADDITIONAL SECTION 404 PERMITS REQUIRED DUE TO FINAL DESIGN & ANY DESIGN CHANGES. DB CONTRACTOR SHALL EVALUATE ALL SECTION 404 IMPACTS & MITIGATION REQUIREMENTS PER THE FINAL DESIGN AND ANY DESIGN CHANGES. DB CONTRACTOR SHALL PREPARE ALL COORDINATION MATERIALS FOR ANY PERMIT AMENDMENTS OR ADDITIONAL SECTION 404 PERMITS & SECTION 401 TIER II CERTIFICATIONS REQUIRED. DB CONTRACTOR SHALL ASSESS ALL MITIGATION REQUIREMENTS, AND IMPLEMENT, MONITOR, AND MAINTAIN ALL MITIGATION REQUIREMENTS DUE TO ANY PERMIT AMENDMENTS OR ADDITIONAL SECTION 404 PERMITS.

**VEGETATION:**

LIMIT REMOVAL OF NATIVE VEGETATION WHEN POSSIBLE. NOTIFY TxDOT DISTRICT ENVIRONMENTAL SECTION 72 HOURS BEFORE REMOVAL OF TREES GREATER THAN 5"/120 mm DIAMETER THAT ARE NOT DESIGNATED ON PLANS. DO NOT REMOVE TREES NEXT TO RIVERS, CREEKS, OR STREAMS UNLESS APPROVED BY THE TxDOT DISTRICT ENVIRONMENTAL SECTION. FLAGGING SHALL BE USED BY CONTRACTOR TO DESIGNATE TREES TO BE REMOVED. APPROVAL FOR REMOVAL OF TREES SHALL BE OBTAINED BY DISTRICT ENVIRONMENTAL SECTION.

**WOODY VEGETATION MUST BE INSPECTED FOR BIRD NESTS BY ENV PERSONNEL PRIOR TO REMOVAL BETWEEN MARCH 1 AND AUGUST 31.**

**VEGETATIVE AREAS OF CONCERN**

Station Number - Lt./Rt. (C/L or B/L)      Commitment/Avoidance

DB CONTRACTOR SHALL EVALUATE FOR ANY VEGETATIVE AREAS OF CONCERN BASED ON FINAL DESIGN AND ANY DESIGN CHANGES.

**COMMENTS**

PER MBTA, NO VEGETATION CONTAINING NESTS, EGGS, OR YOUNG SHALL BE REMOVED SHOULD CLEARING OCCUR DURING THE NESTING SEASON (MARCH 1 - SEPT 30). DB CONTRACTOR SHALL CONDUCT SURVEYS DURING THE NESTING SEASON IN VEGETATED AREAS WHERE WORK IS PROPOSED. RESULTS OF THE SURVEYS SHALL BE PROVIDED TO TxDOT. DB CONTRACTOR SHALL AVOID ENTIRELY ACTIVE BREEDING AREAS OF MIGRATORY BIRDS DURING THE NESTING SEASON. IF ADDITIONAL ASSESSMENT PER THE TxDOT/TPWD MOU IS REQUIRED PER THE FINAL DESIGN OR DESIGN CHANGES, DB CONTRACTOR SHALL PREPARE ALL REQUIRED MATERIALS FOR COORDINATION. DB CONTRACTOR SHALL IMPLEMENT ALL REQUIRED BEST MANAGEMENT PRACTICES & MITIGATION. DB CONTRACTOR SHALL CONDUCT TIER II SITE ASSESSMENT PER TxDOT/TPWD MOU FOR AREAS UNSURVEYED DURING THE FEIS/ROD FIELD STUDIES, PER FINAL DESIGN AND ANY DESIGN CHANGES.

**BENEFICIAL LANDSCAPING/INVASIVE SPECIES/VEGETATION MANAGEMENT**

- COMPLY WITH EXECUTIVE MEMORANDUM FOR BENEFICIAL LANDSCAPE PRACTICES & EO 13112 ON INVASIVE SPECIES
- MINIMIZE DISTURBANCE TO NATURAL AREAS
- RECYCLE TRIMMINGS W/ LOCAL MUNICIPALITY RECYCLING PROGRAM
- REPLANT WITH NATIVE TREES/SHRUBS/VEGETATION
- MINIMIZE THE USE OF HERBICIDES, PESTICIDES AND FERTILIZERS
- MAINTAIN SWP3 STRUCTURES
- FIND LOCAL RECIPIENT FOR NATIVE PLANTS THAT CAN NOT BE REPLANTED ON-SITE

**COMMENTS**

DB CONTRACTOR SHALL USE MINIMIZATION & AVOIDANCE PRACTICES TO PRESERVE VEGETATION TO THE GREATEST EXTENT POSSIBLE. DURING CONSTRUCTION, AREAS OF EXPOSED SOIL SHALL BE REVEGETATED W/ HERBACEOUS SPECIES TO MINIMIZE EROSION. LANDSCAPING SHALL BE IN ACCORDANCE W/ EO 13112 ON INVASIVE SPECIES & EXECUTIVE MEMORANDUM ON BENEFICIAL LANDSCAPING. VEGETATION WITHIN PROJECT ROW SHALL BE MAINTAINED PER STANDARD TxDOT PRACTICES. PROJECT WILL FOLLOW GREEN RIBBON STANDARDS. PROJECT SHALL ACCOMMODATE ALL EXISTING AND FUTURE PEDESTRIAN AND BICYCLE CROSSINGS AT INTERSECTIONS, BRIDGES, AND OVER/UNDERPASSES.

**HAZARDOUS MATERIAL:**

- APPLICABLE TO PROPERTY
- NOT APPLICABLE TO PROPERTY
- INSPECT BRIDGE/STRUCTURE FOR ASBESTOS PRIOR TO WORK/DEMOLITION

**CONDUCT AND DOCUMENT ALL OF THE FOLLOWING:**

CONDUCT SAFETY MEETING PRIOR TO CONSTRUCTION (MAKING WORKERS AWARE OF THE POTENTIAL HAZARDS THEY MAY ENCOUNTER);

READ AND FOLLOW THE HEALTH AND SAFETY PLAN AS SHOWN IN THE SPECIFICATIONS PRIOR TO CONSTRUCTION; AND

CONTACT/COORDINATE WITH THE APPROPRIATE AGENCY 7 TO 10 DAYS PRIOR TO CONSTRUCTION.

**CONTACT AREA ENGINEER IF YOU DETECT:**

DEAD OR DISTRESSED VEGETATION  
 TRASH PILES, DRUMS, CANISTERS, BARRELS, ETC.  
 UNDESIRABLE SMELLS OR ODORS  
 LEACHING OR SEEPAGE OF SUBSTANCES

**HAZARDOUS MATERIAL AREAS OF CONCERN**

Station Number - Lt./Rt. (C/L or B/L)      Commitment/Avoidance

THE FEIS/ROD IDENTIFIES FOUR SITES THAT HAVE THE POTENTIAL TO IMPACT CONSTRUCTION. ADDITIONAL INVESTIGATIONS MAY BE REQUIRED PRIOR TO CONSTRUCTION. SITES INCLUDE:  
 ADKISON READY-MIX CONCRETE INC.  
 KEN'S BREAD & BUTTER  
 PINEHURST CO. SOUTHWESTERN BELL TELEPHONE LP  
 PINEHURST COUNTRY STORE  
 DB CONTRACTOR SHALL EVALUATE FOR HAZARDOUS MATERIAL AREAS OF CONCERN BASED ON FINAL DESIGN AND ANY DESIGN CHANGES.

**COMMENTS**

DB CONTRACTOR SHALL TAKE MEASURES TO PREVENT, MINIMIZE, & CONTROL THE SPILL OF HAZARDOUS MATERIALS. IF HAZARDOUS MATERIALS ARE ENCOUNTERED, DB CONTRACTOR SHALL NOTIFY TxDOT & TAKE STEPS TO PROTECT PERSONNEL & THE ENVIRONMENT. DB CONTRACTOR SHALL HANDLE ALL HAZARDOUS MATERIALS IN ACCORDANCE WITH FEDERAL, STATE, & LOCAL REGULATIONS.

**TRAFFIC CONTROL:**

MAINTENANCE OF THE CURRENT TRAFFIC FLOW ON THE EXISTING ROADWAYS SHALL BE PLANNED & SCHEDULED TO MINIMIZE IMPACTS TO TRAVELING PUBLIC. TRAFFIC CONTROL SHALL BE IN ACCORDANCE W/ PART VI OF THE TMUTCD. EMERGENCY SERVICES SHALL BE NOTIFIED AND BE ACCOMMODATED PRIOR TO CONSTRUCTION AND/OR RAMP CLOSINGS.

**OTHER:**

DB CONTRACTOR SHALL AVOID & MINIMIZE DISRUPTIONS TO UTILITY SERVICES.  
 DB CONTRACTOR SHALL EMPLOY DUST CONTROL MEASURES.

SHEET 1 OF 1



**ENVIRONMENTAL PERMITS ISSUES AND COMMITMENTS**

(EPIC)

FILE:	DN:	CK:	DW:	CK:
© TxDOT 2010	DIST	FED REG	PROJECT NO.	SHEET
	HOU	6		
	COUNTY	CONTROL	SECT	JOB
	MONTGOMERY & CHILES	3635	01	001
		3635	02	001
				SH 249

**ENDANGERED SPECIES/WILDLIFE:**

DO NOT DISTURB OR HARM ENDANGERED SPECIES AND/OR THEIR HABITAT IF LISTED BELOW. VERIFY EXISTENCE OF HABITAT WITH AREA ENGINEER BEFORE CLEARING TREES. MINIMIZE DISTURBANCE TO AREA WILDLIFE

BRIDGE/CULVERT WORK REQUIRES INSPECTION FOR NESTING BIRDS BY ENV PERSONNEL PRIOR TO WORK

**NOTES:**

SENSITIVE SPECIES MAY OCCUR WITHIN THE PROJECT LIMITS (HENSLOW'S SPARROW, RED-COCKADED WOODPECKER, WHOOPING CRANE, PLAINS SPOTTED SKUNK, SOUTHEASTERN MYOTIS BAT, TIMBER/CANEBRAKE RATTLESNAKE, BRANCHED GAY-FEATHER, NAVASOTA LADIES-TRESSES, & TEXAS MEADOW-RUE). DB CONTRACTOR SHALL IMPLEMENT ALL BEST MANAGEMENT PRACTICES & MITIGATION REQUIREMENTS AS IDENTIFIED IN THE SEGMENT 2 FINAL EA. DB CONTRACTOR SHALL MINIMIZE & AVOID IMPACTS TO SENSITIVE SPECIES & THEIR HABITAT BY LIMITING DISTURBANCES WITHIN PROJECT ROW TO ONLY THOSE AREAS NECESSARY TO CONSTRUCT THE PROJECT. DB CONTRACTOR SHALL EVALUATE THE PROJECT FOR SENSITIVE SPECIES AND HABITAT CONCERNS BASED ON FINAL DESIGN AND ANY DESIGN CHANGES.

**COMMENTS**

DB CONTRACTOR SHALL COMPLY WITH ALL FEDERAL & STATE LAWS RELATED TO THREATENED & ENDANGERED SPECIES. DB CONTRACTOR SHALL BE RESPONSIBLE FOR IMPLEMENTING, MONITORING, & MAINTAINING ALL BMPs & MITIGATION REQUIREMENTS W/IN PROJECT ROW IDENTIFIED IN THE SEGMENT 2 FINAL EA AND THROUGH FORTHCOMING COORDINATION W/ REGULATORY AGENCIES. DB CONTRACTOR SHALL BE RESPONSIBLE FOR ALL ADDITIONAL THREATENED & ENDANGERED SPECIES SURVEYS, BMPs, & MITIGATION REQUIREMENTS DUE TO FINAL DESIGN & ANY DESIGN CHANGES.

DB CONTRACTOR SHALL ADHERE TO ALL MBTA GUIDELINES. DB CONTRACTOR SHALL PERFORM A CURSORY NEST SURVEY PRIOR TO CONSTRUCTION & PERFORM CLEARING ACTIVITIES OUTSIDE OF THE NESTING SEASON. ACTIVE BREEDING AREAS SHALL BE AVOIDED. NO VEGETATION CONTAINING NESTS, EGGS, OR YOUNG SHALL BE REMOVED DURING NESTING SEASON (MARCH 1 - SEPTEMBER 1). IF MIGRATORY BIRDS ARE ENCOUNTERED, ACTIVE NESTS, EGGS, AND/OR YOUNG SHALL BE AVOIDED.

**CULTURAL RESOURCES (HISTORICAL/ARCHEOLOGICAL):**

KNOWN ITEMS OF HIST/ARCHEOLOGICAL INTEREST IN PROJECT AREA :

- BUILDINGS
- BRIDGES
- CEMETERIES
- ARCHEOLOGICAL SITES
- HISTORIC MARKERS/PLAQUES
- OTHER

IF ADDITIONAL HISTORICAL OR ARCHEOLOGICAL SITES ARE DISCOVERED DURING CONSTRUCTION IMMEDIATELY NOTIFY AREA ENGINEER AND THE DISTRICT ENVIRONMENTAL SECTION.

**COMMENTS**

DB CONTRACTOR SHALL BE RESPONSIBLE FOR ANY ADDITIONAL CULTURAL RESOURCE SURVEYS, TESTING, & MITIGATION REQUIREMENTS DUE TO FINAL DESIGN & ANY DESIGN CHANGES.

DB CONTRACTOR SHALL NOT PERFORM ANY CONSTRUCTION, STAGING, STORAGE, OR GROUND DISTURBING ACTIVITIES OF ANY KIND WITHIN UNSURVEYED PROPERTIES WITHOUT THE APPROVAL OF TxDOT. IN THE EVENT THAT UNANTICIPATED ARCHEOLOGICAL RESOURCES ARE ENCOUNTERED, WORK IN THE IMMEDIATE AREA SHALL CEASE, AND TxDOT ARCHEOLOGICAL STAFF SHALL BE CONTACTED TO INITIATE POST-REVIEW DISCOVERY PROCEDURES. DB CONTRACTOR SHALL TAKE APPROPRIATE MEASURES TO PROTECT THE SITE FROM FURTHER IMPACT UNTIL EVALUATION OF THE SITE IS COMPLETED. WORK SHALL NOT RESUME IN THE AREA UNTIL DB CONTRACTOR RECEIVES NOTICE FROM TxDOT.

**NOISE:**

NOISE LEVELS IN RESIDENTIAL AREAS AND OTHER SENSITIVE AREAS SHOULD NOT EXCEED THE MAXIMUM ALLOWABLE FOR DAY/NIGHT AS SHOWN IN THE GENERAL NOTES OR AS DIRECTED BY THE ENGINEER, AVOID ROUTING OF CONSTRUCTION EQUIPMENT THROUGH RESIDENTIAL OR SENSITIVE AREAS.

**COMMENTS**

DB CONTRACTOR SHALL MAKE EVERY REASONABLE EFFORT TO MINIMIZE CONSTRUCTION NOISE. DB CONTRACTOR SHALL PROVIDE ALL REQUIRED NOISE ABATEMENT MEASURES. DB CONTRACTOR MAY BE REQUIRED TO REASSESS NOISE IMPACTS AND ABATEMENT MEASURES PER THE FINAL DESIGN AND ANY DESIGN CHANGES. DB CONTRACTOR SHALL PERFORM ALL PUBLIC INVOLVEMENT REQUIREMENTS AND UTILITY EVALUATIONS ASSOCIATED WITH THE IMPLEMENTATION OF NOISE ABATEMENT MEASURES.

**SOUNDWALLS (if Applicable):**

DO NOT LEAVE GAPS BETWEEN PANELS OR POSTS IN NOISE WALLS. IF NEOPRENE PADS ARE REQUIRED, ENSURE THAT THEY ARE PLACED BETWEEN PANELS. DO NOT DAMAGE OR CAUSE EROSION TO ADJACENT PROPERTIES. ENSURE COLOR CONTINUITY FOR CONCRETE MIX THROUGHOUT CONSTRUCTION.

**COMMENTS**

DB CONTRACTOR SHALL REASSESS NOISE IMPACTS & ABATEMENT MEASURES PER THE FINAL DESIGN AND ANY DESIGN CHANGES. DB CONTRACTOR SHALL CONSTRUCT NOISE ABATEMENT MEASURES IN ACCORDANCE WITH APPROPRIATE TxDOT STANDARDS.

**ENVIRONMENTAL ISSUES**

**SEGMENT 2**

**WATER QUALITY:**

- REFER TO STORMWATER POLLUTION PREVENTION PLAN SHEET
- MINIMIZE SEDIMENT RUNOFF
- MINIMIZE POLLUTION
- CONTAIN & PROPERLY DISPOSE OF POTENTIALLY HAZARDOUS SUBSTANCES.
- ALL WORK SHOULD BE PERFORMED ACCORDING TO ALL APPLICABLE STATUTES.

**COMMENTS**

THE PROPOSED PROJECT WOULD DISTURB MORE THAN 5 ACRES. THE DB CONTRACTOR MUST COMPLY WITH THE TPDES CONSTRUCTION GENERAL PERMIT (TXR 150000). DB CONTRACTOR MUST SUBMIT A NOI TO TCEQ AND POST A COPY AT THE CONSTRUCTION SITE. DB CONTRACTOR MUST IMPLEMENT & MAINTAIN A SW3P THROUGHOUT CONSTRUCTION.

**WETLANDS/WATERS OF U.S.:**

NO FILLING, DREDGING OR EXCAVATING IN ANY WATERBODIES, RIVERS, CREEKS, STREAMS OR WET AREAS UNLESS SPECIFICALLY ALLOWED IN UNITED STATES CORPS OF ENGINEERS PERMIT OR APPROVED BY AREA ENGINEER. CONTRACTOR MUST OBTAIN ANY PERMIT FOR TEMPORARY FILL DUE TO CONSTRUCTION METHODS OTHER THAN THOSE SPECIFIED IN PLANS. CONTRACTOR MUST COORDINATE ANY PERMITS WITH THE TxDOT DISTRICT ENVIRONMENTAL SECTION. DO NOT REMOVE AND PLACE ANY FILL MATERIAL, CONSTRUCTION DEBRIS, ETC. ON ADJACENT OR OTHER PROPERTIES WITHOUT PRIOR PERMISSION OF AREA ENGINEER.

- U.S. CORPS OF ENGINEERS PERMIT PERMIT SWF-2016-00348
- U.S. COAST GUARD PERMIT DB CONTRACTOR SHALL COMPLY WITH APPROVED SECTION 404 PERMIT.
- BRIDGE/WATERWAY LOCATION
- KEEP BRIDGE CLEARANCE SAME AS EXISTING

**CONTRACTOR MUST NOTIFY:**

- U.S. COAST GUARD 30 DAYS PRIOR TO BEGINNING CONSTRUCTION
- DISTRICT ENVIRONMENTAL SECTION PRIOR TO BEGINNING CONSTRUCTION
- U.S. COAST GUARD 2 WEEKS PRIOR TO CHANNEL CLOSURES
- U.S. COAST GUARD 1 WEEK PRIOR TO CHANNEL CLOSURES
- U.S. COAST GUARD 48 HRS PRIOR TO CHANNEL CLOSURES
- Coordination with Floodplains Administrator required.

**COMMENTS**

AT THIS TIME, TxDOT ANTICIPATES THAT A NWP 14 W/ A PCN WILL BE REQUIRED FOR THE PROJECT. ONCE FIELD DELINEATIONS ARE COMPLETE AND IF A PCN IS WARRANTED, TxDOT WOULD PURSUE A NWP 14 W/ A PCN. WHEN THE NWP 14 W/ A PCN IS APPROVED BY USACE, THE DB CONTRACTOR SHALL NOT MAKE ANY DESIGN CHANGES OR LOCATE ANY PSLs IN AREAS THAT WOULD REQUIRE IMPACTS TO WATERS OF THE US EXCEEDING THE LIMITS OF A NWP, THUS REQUIRING AN IP. DB CONTRACTOR SHALL EMPLOY MINIMIZATION AND AVOIDANCE MEASURES DURING DESIGN TO AVOID IMPACTS TO WATERS OF THE US. DB CONTRACTOR SHALL EVALUATE ALL SECTION 404 IMPACTS & MITIGATION REQUIREMENTS PER THE FINAL DESIGN AND ANY DESIGN CHANGES. DB CONTRACTOR SHALL BE RESPONSIBLE FOR ANY ADDITIONAL PERMITTING & MITIGATION REQUIREMENTS DUE TO FINAL DESIGN AND ANY DESIGN CHANGES. DB CONTRACTOR SHALL PREPARE ALL COORDINATION MATERIALS FOR PERMIT AMENDMENTS, ADDITIONAL SECTION 404 PERMITS & SECTION 401 CERTIFICATIONS DUE TO FINAL DESIGN AND ANY DESIGN CHANGES. DB CONTRACTOR SHALL ASSESS ALL MITIGATION REQUIREMENTS AND IMPLEMENT, MONITOR, & MAINTAIN ANY ADDITIONAL MITIGATION REQUIREMENTS RESULTING FROM FINAL DESIGN AND ANY DESIGN CHANGES. ALL KNOWN IMPACTS TO SEGMENT 2 WATERS OF THE US ARE IDENTIFIED ON THE PRELIMINARY SCHEMATIC DESIGN.

**VEGETATION:**

LIMIT REMOVAL OF NATIVE VEGETATION WHEN POSSIBLE. NOTIFY TxDOT DISTRICT ENVIRONMENTAL SECTION 72 HOURS BEFORE REMOVAL OF TREES GREATER THAN 5"/120 mm DIAMETER THAT ARE NOT DESIGNATED ON PLANS. DO NOT REMOVE TREES NEXT TO RIVERS, CREEKS, OR STREAMS UNLESS APPROVED BY THE TxDOT DISTRICT ENVIRONMENTAL SECTION. FLAGGING SHALL BE USED BY CONTRACTOR TO DESIGNATE TREES TO BE REMOVED. APPROVAL FOR REMOVAL OF TREES SHALL BE OBTAINED BY DISTRICT ENVIRONMENTAL SECTION.

**WOODY VEGETATION MUST BE INSPECTED FOR BIRD NESTS BY ENV PERSONNEL PRIOR TO REMOVAL BETWEEN MARCH 1 AND SEPTEMBER 1.**

**VEGETATIVE AREAS OF CONCERN**

NAVASOTA LADIES-TRESSES MAY OCCUR WITHIN THE PROJECT LIMITS. DB CONTRACTOR SHALL IDENTIFY AND DOCUMENT ALL NAVASOTA LADIES-TRESSES WITHIN PROJECT ROW FOR COORDINATION WITH APPLICABLE AGENCIES. DB CONTRACTOR SHALL IMPLEMENT, MONITOR, MAINTAIN ALL BMPs & MITIGATION MEASURES WITHIN PROJECT ROW IDENTIFIED THROUGH COORDINATION. DB CONTRACTOR SHALL BE RESPONSIBLE FOR ALL ADDITIONAL THREATENED & ENDANGERED SPECIES SURVEYS, BMPs, & MITIGATION REQUIREMENTS DUE TO FINAL DESIGN & ANY DESIGN CHANGES.

**COMMENTS**

DB CONTRACTOR SHALL USE MINIMIZATION & AVOIDANCE PRACTICES TO PRESERVE VEGETATION TO THE GREATEST EXTENT POSSIBLE. DB CONTRACTOR SHALL EVALUATE VEGETATION IMPACTS FOR ANY WORK OUTSIDE OF THE PROJECT ROW PER THE SEPTEMBER 13, 2013 TxDOT-TPWD MOU. DB CONTRACTOR SHALL COORDINATE THEIR FINDINGS WITH TxDOT & DB CONTRACTOR SHALL PREPARE ANY ADDITIONAL ASSESSMENTS REQUIRED. DB CONTRACTOR SHALL IMPLEMENT ALL REQUIRED BEST MANAGEMENT PRACTICES & MITIGATION. DB CONTRACTOR SHALL NOTIFY TxDOT OF OPPORTUNITIES FOR TPWD TO VISIT THE PROJECT SITE FOR COLLECTION AND RELOCATION OF THE TEXAS MEADOW RUE & BRANCHED GAY-FEATHER.

**BENEFICIAL LANDSCAPING/INVASIVE SPECIES/VEGETATION MANAGEMENT**

- COMPLY WITH TxDOT'S VEGETATION MANAGEMENT GUIDELINES, EXECUTIVE MEMORANDUM FOR BENEFICIAL LANDSCAPE PRACTICES & EO 13112 ON INVASIVE SPECIES
- MINIMIZE DISTURBANCE TO NATURAL AREAS
- RECYCLE TRIMMINGS W/LOCAL MUNICIPALITY RECYCLING PROGRAM
- REPLANT WITH NATIVE TREES/SHRUBS/VEGETATION
- MINIMIZE THE USE OF HERBICIDES, PESTICIDES AND FERTILIZERS
- MAINTAIN SWP3 STRUCTURES

**COMMENTS**

DB CONTRACTOR SHALL USE MINIMIZATION & AVOIDANCE PRACTICES TO PRESERVE VEGETATION TO THE GREATEST EXTENT POSSIBLE, INCLUDING PRESERVATION OF MATURE TREES, PARTICULARLY MAST SPECIES.

**HAZARDOUS MATERIAL:**

- APPLICABLE TO PROPERTY
- NOT APPLICABLE TO PROPERTY
- INSPECT BRIDGE/STRUCTURE FOR ASBESTOS PRIOR TO WORK/DEMOLITION

**CONDUCT AND DOCUMENT ALL OF THE FOLLOWING:**

CONDUCT SAFETY MEETING PRIOR TO CONSTRUCTION (MAKING WORKERS AWARE OF THE POTENTIAL HAZARDS THEY MAY ENCOUNTER):

READ AND FOLLOW THE HEALTH AND SAFETY PLAN AS SHOWN IN THE SPECIFICATIONS PRIOR TO CONSTRUCTION; AND

CONTACT/COORDINATE WITH THE APPROPRIATE AGENCY 7 TO 10 DAYS PRIOR TO CONSTRUCTION.

**CONTACT AREA ENGINEER IF YOU DETECT:**

DEAD OR DISTRESSED VEGETATION  
TRASH PILES, DRUMS, CANISTERS, BARRELS, ETC.  
UNDESIRABLE SMELLS OR ODORS  
LEACHING OR SEEPAGE OF SUBSTANCES

**COMMENTS**

DB CONTRACTOR SHALL TAKE MEASURES TO PREVENT, MINIMIZE, & CONTROL THE SPILL OF HAZARDOUS MATERIALS. IF HAZARDOUS MATERIALS ARE ENCOUNTERED, DB CONTRACTOR SHALL NOTIFY TxDOT & TAKE STEPS TO PROTECT PERSONNEL & THE ENVIRONMENT. DB CONTRACTOR SHALL HANDLE ALL HAZARDOUS MATERIALS IN ACCORDANCE WITH FEDERAL, STATE, & LOCAL REGULATIONS. DB CONTRACTOR SHALL EVALUATE & MITIGATE ALL ADDITIONAL HAZARDOUS MATERIAL LOCATIONS DUE TO FINAL DESIGN & ANY DESIGN CHANGES.

**TRAFFIC CONTROL:**

DB CONTRACTOR SHALL MINIMIZE TRAFFIC DISRUPTIONS THROUGH TIMELY NOTIFICATION OF THOSE AFFECTED. DB CONTRACTOR SHALL COMPLY WITH ALL LOCAL, STATE, & FEDERAL TRAFFIC & SAFETY REGULATIONS. SIGNAGE & BARRIER PLACEMENT SHALL BE ALERT TO REORDERING OF TRAVEL PATTERNS DURING CONSTRUCTION & LONG TERM.

**AIR QUALITY:**

DB CONTRACTOR SHALL EMPLOY NECESSARY DUST & EMISSION CONTROL MEASURES.

**CONSTRUCTION:**

DB CONTRACTOR SHALL FOLLOW CLEAN/DRAIN/DRY PROTOCOLS TO AVOID SPREADING INVASIVE SPECIES INTO NON-INFESTED WATER BODIES. DB CONTRACTOR SHALL NOT PLACE RIP RAP & BARRIERS THAT WOULD IMPEDE WILDLIFE MOVEMENTS. HAY BALES USED FOR SEDIMENT CONTROL SHALL BE WEED-FREE & LOCALLY GROWN, & LEFT IN PLACE TO BREAK DOWN NATURALLY.

SHEET 1 OF 1



**ENVIRONMENTAL PERMITS  
ISSUES AND COMMITMENTS**

(EPIC)

FILE:	DN:	CK:	DW:	CK:
© TxDOT 2010	DIST	FED REG	PROJECT NO.	SHEET
	COUNTY	CONTROL	SECT	JOB
	GRIMES	3635	02	002 SH 249



Texas Department of Transportation  
Technical Provisions  
for  
SH 249 Extension

Attachment 5-1  
TxDOT Third Party Agreements

February 9, 2017

#49. N. 1.  
4-21-15

**RESOLUTION AND ORDER**

On this the 21<sup>st</sup> day of April, 2015, at a Regular Session Meeting of the Commissioners Court of Montgomery County, Texas, there came on for consideration and approval a motion to ratify the Court's approval of the SH 249 Construction, Operation and Maintenance Agreement between the State of Texas, acting by and through the Texas Department of Transportation (hereinafter "TxDOT") and Montgomery County, acting by and through the Montgomery County Toll Road Authority (hereinafter "County") previously executed on January 26, 2015 by Craig Doyal, County Judge on behalf of Montgomery County, Texas.

WHEREAS, the SH 249 Construction, Operation and Maintenance Agreement (the "Agreement") was executed by County prior to the determination of the amount of the potential reimbursement by the Montgomery County Toll Road Authority ("MCTRA") to the State of Texas for the right-of-way previously acquired by TxDOT and was subsequently executed by TxDOT including the amount of potential reimbursement for previously required right-of-way;

WHEREAS, County desires to ratify the completed contract to reflect the amount of potential reimbursement for the previously required right-of-way

Motion was made by Commissioner Noack and seconded by Commissioner Meador to hereby ratify and approve the Agreement previously executed by County Judge Craig Doyal on behalf of Montgomery County, Texas.

Said Motion being put to a vote, it carried by a vote of 4 aye votes to 0 nay votes.

**THEREFORE, IT IS HEREBY APPROVED AND ORDERED** that this Commissioners Court ratifies and approves the SH 249 Construction, Operation and Maintenance Agreement as attached to this Resolution and Order and presented to Commissioners Court as the Agreement of Montgomery County, Texas.

PASSED AND APPROVED this 21<sup>st</sup> day of April, 2015.

**MONTGOMERY COUNTY, TEXAS**

Craig Doyal  
Craig Doyal, County Judge

Mike Meador  
Mike Meador, Commissioner Pct. 1

Charlie Riley  
Charlie Riley, Commissioner Pct. 2

James Noack  
James Noack, Commissioner Pct. 3

Jim Clark  
Jim Clark, Commissioner Pct. 4

Attest:

Mark Turnbull  
Mark Turnbull, County Clerk

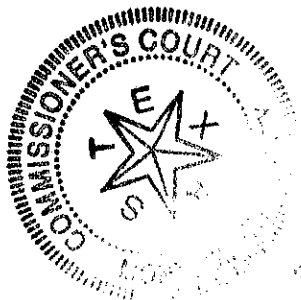

JAN 26 2015

SH 249

## MONTGOMERY COUNTY

## CONSTRUCTION, OPERATION AND MAINTENANCE AGREEMENT

THIS AGREEMENT (this "Agreement"), by and between the State of Texas, acting by and through the Texas Department of Transportation (hereinafter called "TxDOT"), and Montgomery County, Texas, acting by and through the Montgomery County Toll Road Authority (hereinafter called the "County"), is to become effective when fully executed by both parties (the "Effective Date").

WITNESSETH

WHEREAS, the County and TxDOT have been working in partnership to develop the State Highway 249 corridor in the County, which is a designated part of the State Highway System;

WHEREAS, on December 13, 2007, the Texas Transportation Commission (hereinafter called the "Commission") passed Minute Order 111168, designating a portion of State Highway 249 from Spring Cypress Road in Harris County to FM 1774 in Montgomery County as a future toll facility;

WHEREAS, the County and TxDOT have been engaged in the planning and development of a proposed toll facility in the State Highway 249 corridor from the Montgomery/Harris county line to FM 1774 just north of the Montgomery/Grimes county line (hereinafter called the "SH 249 Project"), with the SH 249 Project scope and alignment to be determined in accordance with the environmental process and analysis of financial feasibility;

WHEREAS, Chapter 373, Transportation Code, authorizes the County to construct, operate and maintain toll road facilities, and authorizes TxDOT to make available state highway right-of-way to be used for such purposes, provided that the County pay an amount to reimburse TxDOT's actual costs to acquire the right-of-way, and authorizes the Commission or TxDOT to waive the County's reimbursement obligation;

WHEREAS, pursuant to that authority, the County will finance, design, construct, operate and maintain the segment of the SH 249 Project between the Harris County line and FM 1774 in Pinehurst (hereinafter called the "County Project"), with the County Project to be constructed on State right-of-way (hereinafter called the "State Highway Facility"), as more particularly described in Exhibit "A" to this Agreement;

WHEREAS, TxDOT will finance, design, construct, operate and maintain the segment of the Project between FM 1774 in Pinehurst and FM 1774 in Grimes County near Todd Mission (hereinafter called the "TxDOT Project"), as more particularly described in Exhibit "A" to this Agreement;

WHEREAS, TxDOT and the County acknowledge that the TxDOT Project is not suitable to being delivered under a concession agreement, and that the TxDOT Project will be delivered using the design-build or design-bid-build delivery methodology;

WHEREAS, the development and construction of the SH 249 Project is critical to the Greater Houston region and essential for the future movement of people and goods through Grimes, Montgomery, Harris, and Brazos counties, and will bring jobs and economic development to the County and relieve congestion in the region;

WHEREAS, TxDOT has determined that the State of Texas will receive substantial benefits from toll road projects to be constructed, operated and maintained by the County, and as provided in this Agreement authorizing use of the State Highway Facility by the County for such purposes;

WHEREAS, on FEBRUARY 24, 2015, the Commission adopted Minute Order 114204 authorizing the Executive Director of TxDOT to enter into this Agreement, and authorizing the County use of the State Highway Facility to develop, construct, operate and maintain the County Project as part of the county road system, and for the County to reimburse the State for the use of the State Highway Facility; provided that if the value of the State right-of-way needed by the County to construct the County Project is less than the estimated value of the right-of-way the County transfers to TxDOT for the construction of the TxDOT Project, such reimbursement obligation shall be waived; and

WHEREAS, the Montgomery County Commissioners Court has approved entering into this Agreement by order dated January 26, 2015, which is attached hereto and made a part hereof as Exhibit "B";

NOW THEREFORE, in consideration of the mutual covenants and agreements of the parties hereto to be by them respectively kept and performed as hereinafter set forth, TxDOT and the County mutually agree as follows:

1. **Toll Project Agreement.** The parties acknowledge and agree that this Agreement is a toll project agreement under Section 373.006, Transportation Code, and is intended to be an alternative to the primacy determination process under Subchapter B of Chapter 373, Transportation Code, for the development of the SH 249 Project. The SH 249 Project shall be developed in accordance with the terms and conditions of this Agreement, and this Agreement alters and replaces the steps and time limits specified in Subchapter B of Chapter 373 with the terms and conditions of this Agreement.

2. **Waiver of Process.** In accordance with Section 373.055, Transportation Code, the parties waive the process established in Subchapter B of Chapter 373 and acknowledge and agree that this Agreement constitutes written notification of such waiver and satisfies the written notification requirements of Section 373.055. The parties acknowledge and agree that this

Agreement shall govern the process for development of the SH 249 Project. As such, this Agreement is intended to alter, by replacement of, and substitution with the terms and conditions of this Agreement in its entirety, the steps and time limits specified in Subchapter B, including the timing of or conditions for initiating the primacy process.

**3. Responsibility for the TxDOT Project.**

a. TxDOT will complete the environmental documents for the TxDOT Project, and will finance and/or fund, acquire right-of-way, design, construct, maintain, and operate the TxDOT Project. The scope of the TxDOT Project will be determined once financial feasibility is completed by TxDOT. The parties acknowledge the mutual intent for TxDOT to construct up to two tolled lanes in each direction from FM 1774 in Pinehurst to FM 1774 in Grimes County near Todd Mission. The County acknowledges its interest in the development of the TxDOT Project in the County, and will work cooperatively with TxDOT in ongoing planning, environmental, and project development efforts.

b. The Commission has allocated \$193 million to complete the TxDOT Project. In the event debt is issued by the Commission to fund TxDOT Project costs, that debt will be secured solely by TxDOT Project toll revenues. TxDOT is not obligated to provide funding above the sum of the amount allocated by the Commission and the amount that can be financed from TxDOT Project toll revenues. If TxDOT Project costs plus the construction contingency and amounts necessary to fund appropriate financial reserves exceeds that amount, TxDOT and the County will reduce the TxDOT Project scope as necessary to complete the TxDOT Project within budget. Alternatively, if the TxDOT Project and related costs are less than the amount of funding available as provided above, TxDOT may use the excess in other sections of the corridor.

c. The County will provide stream and wetlands mitigation credits for the TxDOT Project. TxDOT will reimburse the County's costs in providing those credits as part of the TxDOT Project costs.

d. The County will work with landowners to obtain the right-of-way needed for the ultimate limits of the TxDOT Project, and commits to using its best efforts to secure as many right-of-way donations as possible. TxDOT will acquire any right-of-way needed for the ultimate limits of the TxDOT Project that is not acquired by the County. The TxDOT Project scope may be reduced as necessary because of the costs of non-donated right-of-way. The County will transfer the right-of-way acquired by the County to TxDOT upon the Commission's award of a construction contract for the TxDOT Project.

e. TxDOT commits to using its best efforts to procure and develop the TxDOT Project so that the TxDOT Project will open to traffic at approximately the same time as the County Project and the Harris County project in the State Highway 249 corridor from Spring-Cypress Road to just south of the Montgomery County line, or shortly thereafter. TxDOT reserves the right to not issue a notice to proceed under the

construction contract(s) for the TxDOT Project until the County finances the County Project and enters into a construction contract(s) for the County Project.

f. If TxDOT does not advance the segment of the TxDOT Project from FM 1774 in Pinehurst to FM 1488 by the deadline agreed to by TxDOT and the County, the County has the option to finance, acquire right-of-way, design, construct, maintain, and operate that portion of the TxDOT Project. If the County exercises that option, the County will reimburse TxDOT for any TxDOT Project-related information made available by TxDOT that the County uses in its completion of the TxDOT Project.

g. TxDOT will be responsible for all operations and maintenance of the TxDOT Project, and will be responsible for toll collection and toll operations. The TxDOT Project will be operated as part of the State Highway System. TxDOT, in cooperation with the County, will establish a toll setting and escalation structure and toll operations policy applicable to the TxDOT Project to be presented to the Commission. The Commission will set the toll rates for the TxDOT Project. The toll operations policy will allow TxDOT, at its discretion, to waive required toll collection on the TxDOT Project during reconstruction activities or at other times when operationally necessary or in accordance with the free passage policies adopted by the Commission that are applicable to the TxDOT Project.

#### **4. Responsibility for the County Project.**

a. The County will finance, acquire right-of-way, design, construct, maintain, and operate the County Project. The County is hereby authorized to use and will be allowed to utilize a portion of the State Highway Facility for the construction, operation and maintenance of the County Project, all as described in attached Exhibit "A," provided that such uses will not damage, impair safety, impede maintenance, or otherwise restrict operation of the balance of the State Highway Facility, all as determined from engineering and traffic investigations conducted by the State in accordance with terms or procedures mutually agreed to by the State and the County. The State and County agree to take all reasonable actions and to cooperate and coordinate with each other and to cause their contractors to cooperate and coordinate with each other to ensure the timely construction and completion of the County Project.

b. Subject to the requirements of subsection 4.a., development of plans for the County Project will be the responsibility of the County, but shall be coordinated with TxDOT at all stages and shall be submitted to TxDOT for review and approval prior to award of the construction contract(s) for the County Project. Significant field changes shall likewise be submitted to TxDOT prior to being accomplished. All maintenance of the County Project shall be the responsibility of the County, and the County shall have all responsibility to the public for the design, maintenance, signing, and lighting on the County Project. TxDOT shall be responsible for the operation and maintenance of the frontage roads that are adjacent to the County Project. Specifications for such plans and any field changes to the County Project and the frontage roads shall be in accordance with the latest standards required by TxDOT.

c. The County will award and fully fund any necessary contract(s) for construction of the County Project. TxDOT, at any time during such construction, after providing reasonable notice to the County, can inspect any work performed under such contract(s) for compliance with engineering and design plans and specifications.

d. The County, at its sole expense, will obtain the necessary stream and wetlands mitigation credits for the County Project.

e. The County shall send written notification to TxDOT upon the final completion of the County Project. At the earliest possible date thereafter, the County will deliver to TxDOT the final sets of plans and specifications (the "Record Documents"). The notification shall include the date of final completion and a certification that the County Project has been constructed according to approved plans and specifications and Record Documents.

f. TxDOT and the County agree to divide the responsibility for the maintenance of the State Highway Facility and the Project as specified in Exhibit "A" attached hereto and this Section 4. It is understood and agreed that for so long as the County Project is tolled by the County as part of its toll road system, it will not be designated as part of the State Highway System and shall be considered as part of the County toll road system and all laws relating to the maintenance and operation of county roads are made applicable.

g. In the event that TxDOT determines that the County's operation of the County Project materially interferes with or adversely affects the general highway use of its portion of the State Highway Facility, TxDOT will consult with the County, and such modifications or remedial actions acceptable to both parties for the continued operation of the County Project will be accomplished and shall be done at the sole expense of the County.

h. It is understood and agreed that the operation of the County Project or the State Highway Facility may by necessity be curtailed temporarily in the event of damage caused by flood, accidents or other similar causes. In that event, the County shall be responsible for repairing any damage to the County Project, and TxDOT shall be responsible for repairing any damage to the State Highway Facility. The parties will do everything reasonable to provide for rapid and timely repairs to those portions which are damaged to ensure that the operation of the respective facility will be reinstated as soon as possible.

i. If the County does not advance the County Project by the deadline agreed to by TxDOT and the County, TxDOT has the option to finance, acquire right-of-way, design, construct, maintain, and operate the County Project. If TxDOT exercises that option, TxDOT will reimburse the County for any County Project-related information made available by the County that TxDOT uses in its completion of the County Project.

j. The County, in cooperation with TxDOT, will establish a toll setting and escalation structure and toll operations policy applicable to the County Project.

5. **Reimbursement for Use of Right-of-Way.** If the value of the State right-of-way needed by the County to construct the County Project, as defined below, is less than the estimated value of the right-of-way the County transfers to TxDOT for the construction of the TxDOT Project, the County's obligation to reimburse TxDOT for use by the County of the State Highway Facility shall be waived. The value of the right-of-way transferred by the County shall be determined in a mutually agreed upon manner. The County shall otherwise make payment in the amount of \$ 3,867,200 to TxDOT as reimbursement under Section 373.102, Transportation Code and other costs, for use by the County of the State Highway Facility. This amount equals the sum of (a) TxDOT's actual costs to acquire the right-of-way transferred to the County for use of the State Highway Facility, or an amount equal to the average actual historical right-of-way acquisition values for comparable right-of-way located in proximity to the Project on the date of original acquisition of the right-of-way, and (b) an amount determined by TxDOT and the County to be sufficient to reimburse TxDOT for costs of improvements to the State Highway Facility incurred by TxDOT prior to the Effective Date of this Agreement. If required, the County shall make payment to TxDOT prior to the award of the construction contract(s) for the County Project.

6. **Additional Regional Roadway Projects.** TxDOT and the County will work with the Houston-Galveston Area Council (H-GAC), the metropolitan planning organization for the area in which the SH 249 Project is located, to identify, prioritize, and finance regional roadway projects that will facilitate mobility by connecting to the SH 249 Project.

7. **Successors and Assigns.** This Agreement shall bind, and shall be for the sole and exclusive benefit of the respective parties and their legal successors.

8. **Assignment.** The County shall not assign, sublet, or transfer its interest in this Agreement without the prior written consent of TxDOT.

9. **Severability.** If any provision of this Agreement or the application thereof to any person or circumstance, is rendered or declared illegal for any reason and shall be invalid or unenforceable, the remainder of the Agreement and the application of such provision to other persons or circumstances shall not be affected thereby but shall be enforced to the greatest extent permitted by applicable law.

10. **Amendments.** No amendment to this Agreement shall be of any effect unless in writing and executed by both the County and TxDOT.

11. **Defaults and Remedies.** Default shall occur only in the event either party fails to comply with its respective obligations hereunder. In such event, the non-defaulting party shall give the defaulting party written notice of the condition of default. The defaulting party may cure such default within thirty (30) days from and after date of receipt of notice of default. In the event of continued failure to cure or continued absence of efforts to cure such default, the non-defaulting party may thereafter notify the defaulting party of its intent to terminate this Agreement. This Agreement shall not be considered as specifying the exclusive remedy for any default, but all remedies existing at law and in equity may be availed of by either party and shall be cumulative.



12. **Termination of Agreement.** This Agreement may be terminated upon the occurrence of any of the following conditions:

- a. the Agreement is terminated in writing with the mutual consent of the parties;
- b. the Agreement is terminated by either party because of a material breach by the other party; or
- c. by satisfactory completion of all responsibilities and obligations described herein.

13. **Notices.** All notices to either party by the other required under this Agreement shall be delivered personally or sent by certified or registered U. S. Mail, postage prepaid, addressed to such party at the following respective addresses:

The County:

Craig Doyal  
Montgomery County Toll Road  
Authority  
501 North Thompson, Suite 401  
Conroe, Texas 77301

TxDOT:

District Engineer  
Texas Department of Transportation  
P.O. Box 1386  
Houston, Texas 77251-7386

All notices shall be deemed given on the date so delivered or so deposited in the mail, unless otherwise provided herein. Either party hereto may change the above address by sending written notice of the change to the other party. Either party may request in writing that such notices shall be delivered personally or by certified U.S. mail and such request shall be honored and carried out by the other party.

14. **Relationship of the Parties.** Except for the limited purposes expressly stated herein, nothing in this Agreement shall be deemed or construed by the parties, or by any third party, as creating the relationship of principal and agent between TxDOT and the County. Neither TxDOT nor the County waives, relinquishes, limits or conditions its governmental immunity or any other right to avoid liability which it otherwise might have to third parties.

15. **Sole Benefit.** This Agreement is entered into for the sole benefit of TxDOT and the County and their respective successors and permitted assigns. Nothing in this Agreement or in any approval subsequently provided by either party hereto shall be construed as creating any liability in favor of any third party or parties against either TxDOT or the County, relieving any third party or parties from any liabilities of such third party or parties to TxDOT or the County, or giving any benefits, rights, remedies, or claims to any other public or private person, firm, corporation or other entity.

16. **Authorization.** Each party to this Agreement represents to the other that it is fully authorized to enter into this Agreement and to perform its obligations hereunder, and that no waiver, consent, approval, or authorization from any third party is required to be obtained or made in connection with the execution, delivery, or performance of this Agreement. Each

signatory on behalf of TxDOT and the County, as applicable, is fully authorized to bind that entity to the terms of this Agreement.

17. **Rights of State Auditor.** The state auditor may conduct an audit or investigation of any entity receiving funds from the state directly under the contract or indirectly through a subcontract under the contract. Acceptance of funds directly under the contract or indirectly through a subcontract under this contract acts as acceptance of the authority of the state auditor, under the direction of the legislative audit committee, to conduct an audit or investigation in connection with those funds. ~~An entity that is the subject of an audit or investigation must~~ provide the state auditor with access to any information the state auditor considers relevant to the investigation or audit.

[SIGNATURE PAGE FOLLOWS]

IN WITNESS WHEREOF, the Texas Department of Transportation and Montgomery County, Texas have executed this Agreement in multiple counterparts on the dates shown herein below, effective on the date last executed.

APPROVED AS TO FORM:

MONTGOMERY COUNTY, TEXAS

J.D. Lambright  
County Attorney

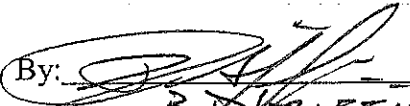
By:   
B. D. GRIFFIN  
Assistant County Attorney

By:   
Craig Doyal, County Judge  
Date January 26, 2015

MONTGOMERY COUNTY TOLL ROAD AUTHORITY

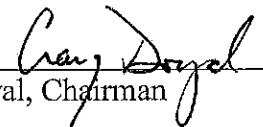
By:   
Craig Doyal, Chairman

TEXAS DEPARTMENT OF TRANSPORTATION

  
LtGen J.F. Weber, USMC (Ret)  
Executive Director  
Date 04/13/2015

Exhibit "A"

[to be attached]

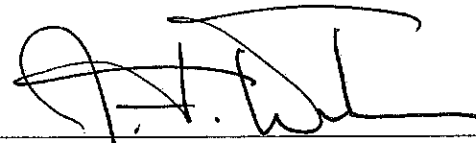

Texas Department of Transportation  
**SH 249**  
**EXTENSION**  
**EXHIBIT A**  
**TYPICAL SECTIONS**

SECTION	PROJECT NO.	SHEET NO.
1	249	1
DATE	STATE	SECTION
11/21/15	TEXAS	1
BY	CHK'D	DATE
...	...	...

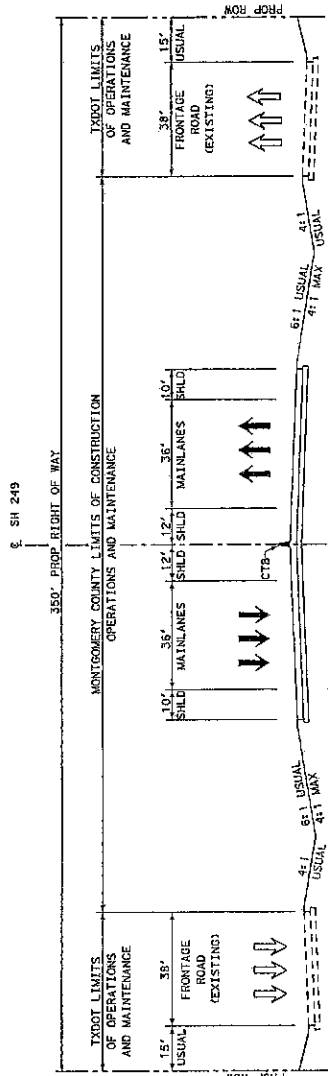

**MAINLANES AND FRONTAGE ROADS**  
**HARRIS COUNTY LINE TO FM 1774 IN PINEHURST**  
(IN 1. S.)

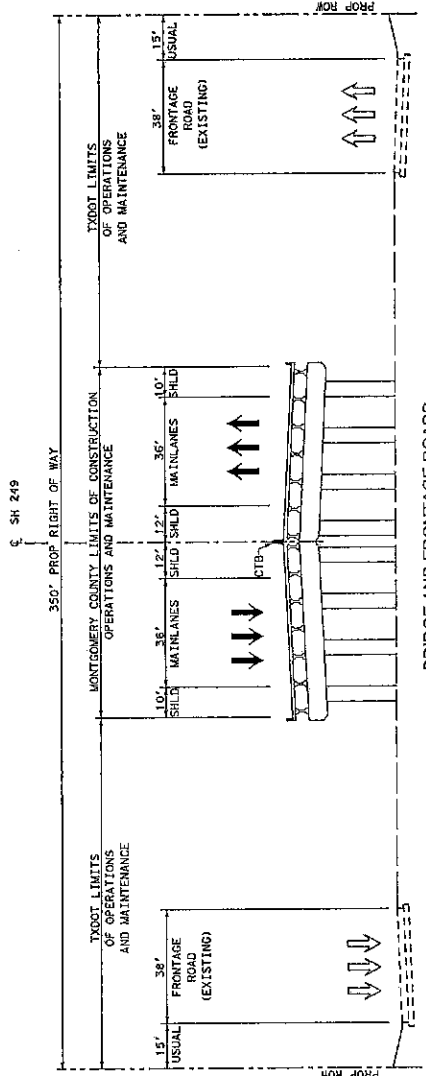

**BRIDGE AND FRONTAGE ROADS**  
**HARRIS COUNTY LINE TO FM 1774 IN PINEHURST**  
(IN 1. S.)

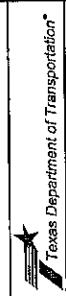

SH 249  
 EXTENSION  
 EXHIBIT A  
 TYPICAL SECTIONS

NO.	DATE	BY	CHKD	APP'D	REVISION
1	01/21/16	49295KMB11443			ISSUED FOR CONSTRUCTION
2					
3					

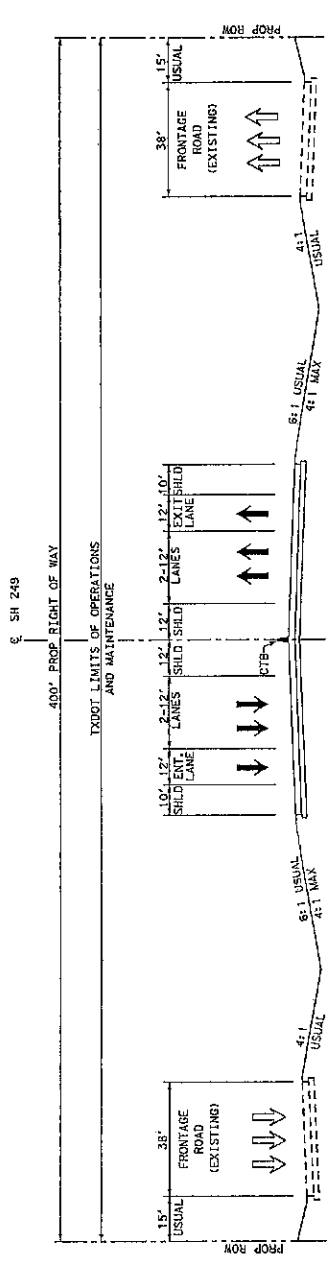

MAINLANES AND FRONTAGE ROADS  
 FM 1774 in PINEHURST TO FM 149  
 (N. T. S.)

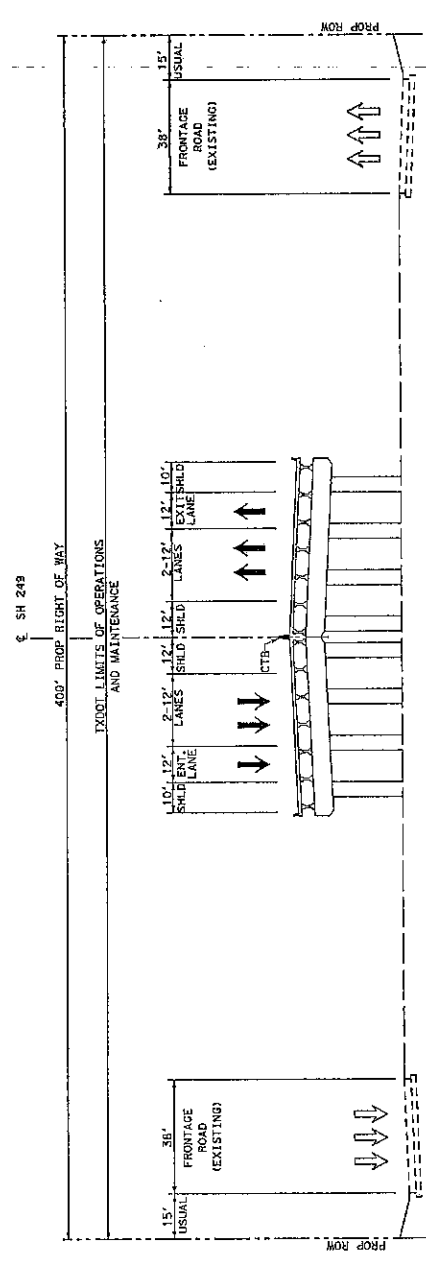

BRIDGE AND FRONTAGE ROADS  
 FM 1774 in PINEHURST TO FM 149  
 (N. T. S.)

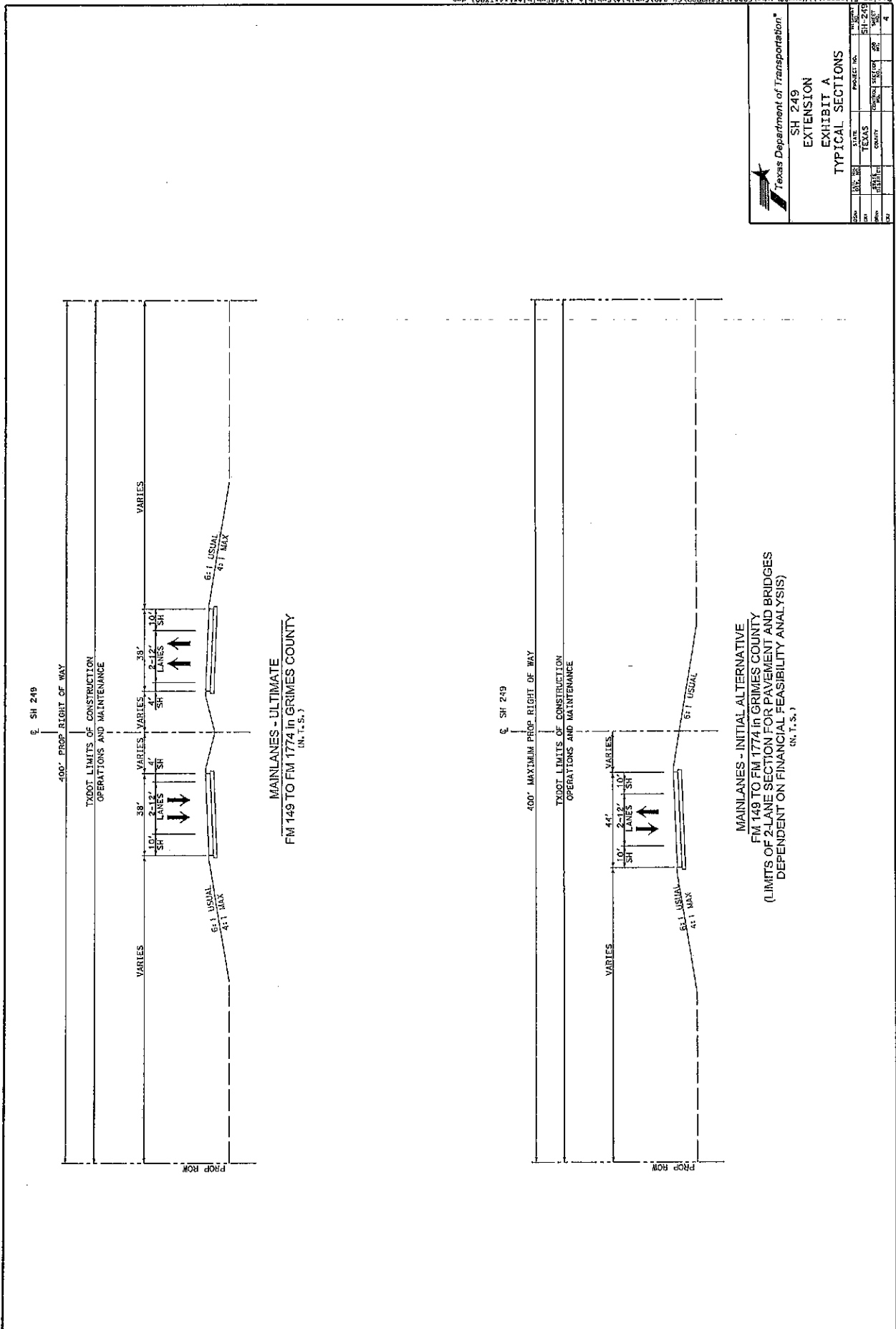

SH 249

400' PROP. RIGHT OF WAY  
TYPICAL LIMITS OF CONSTRUCTION  
OPERATIONS AND MAINTENANCE

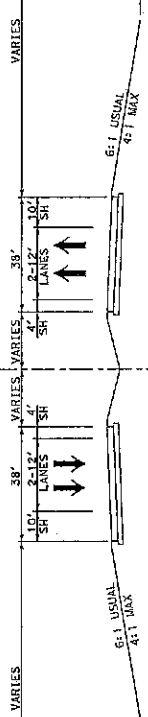

MAINLANES - ULTIMATE  
FM 149 TO FM 1774 in GRIMES COUNTY  
(N.T.S.)

SH 249

400' MAXIMUM PROP. RIGHT OF WAY  
TYPICAL LIMITS OF CONSTRUCTION  
OPERATIONS AND MAINTENANCE

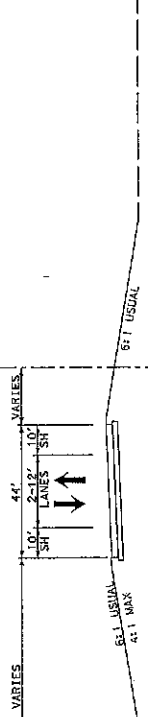

MAINLANES - INITIAL ALTERNATIVE  
FM 149 TO FM 1774 in GRIMES COUNTY  
(LIMITS OF 2-LANE SECTION FOR PAVEMENT AND BRIDGES  
DEPENDENT ON FINANCIAL FEASIBILITY ANALYSIS)  
(N.T.S.)



Texas Department of Transportation	
SH 249	PROJECT NO.
EXTENSION	STATE
EXHIBIT A	TEXAS
TYPICAL SECTIONS	COUNTY
	SHEET
	OF



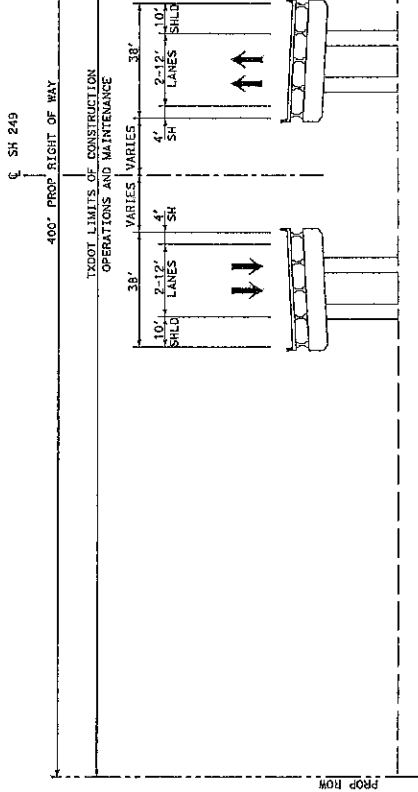

BRIDGE - ULTIMATE  
FM 149 TO FM 1774 in GRIMES COUNTY  
(N.T.S.)

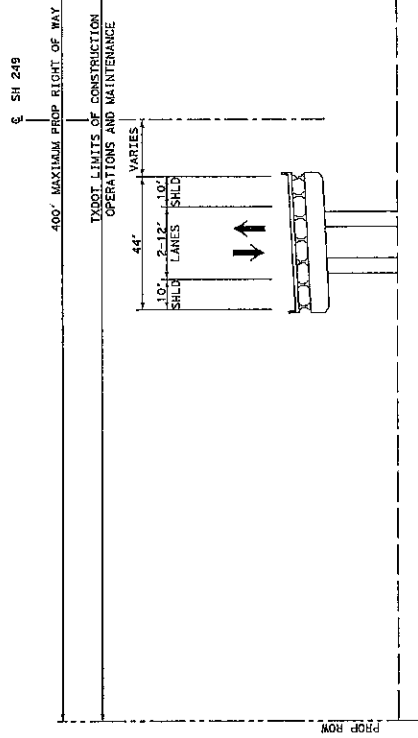

BRIDGE - INITIAL ALTERNATIVE  
FM 149 TO FM 1774 in GRIMES COUNTY  
(LIMITS OF 2-LANE SECTION FOR PAVEMENT AND BRIDGES  
DEPENDENT ON FINANCIAL FEASIBILITY ANALYSIS)  
(N.T.S.)

Texas Department of Transportation

SH 249  
EXTENSION  
EXHIBIT A  
TYPICAL SECTIONS

PROJECT NO.	DATE	STATE	COUNTY	DISTRICT	SECTION	NO.
102-25	10/15/11	TEXAS	GRIMES	1	SH-249	4.A

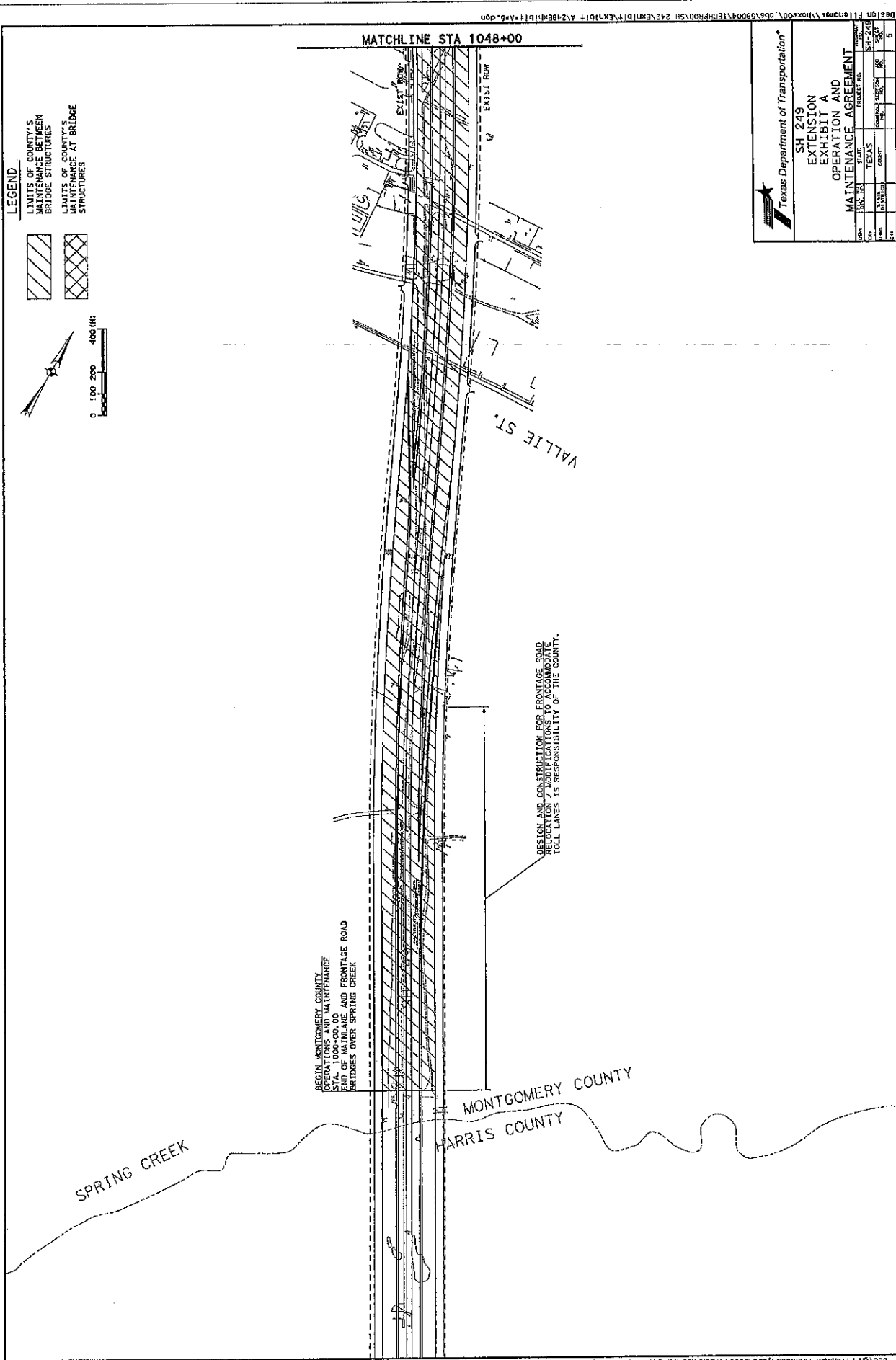

Project File Name: \\h00x00\jobs\59004\TECH\RD\SH 249\Plan\1048+00\1117.dgn  
 Scale: 400,00000001,000000  
 Plotted on: 1/21/2015 10:28

Texas Department of Transportation*	
SH 249	
EXTENSION	
EXHIBIT A	
OPERATION AND	
MAINTENANCE AGREEMENT	
CONTRACT NO.	PROJECT NO.
STATE	COUNTY
CITY	SECTION
DATE	SCALE
BY	APP'D
IN	D

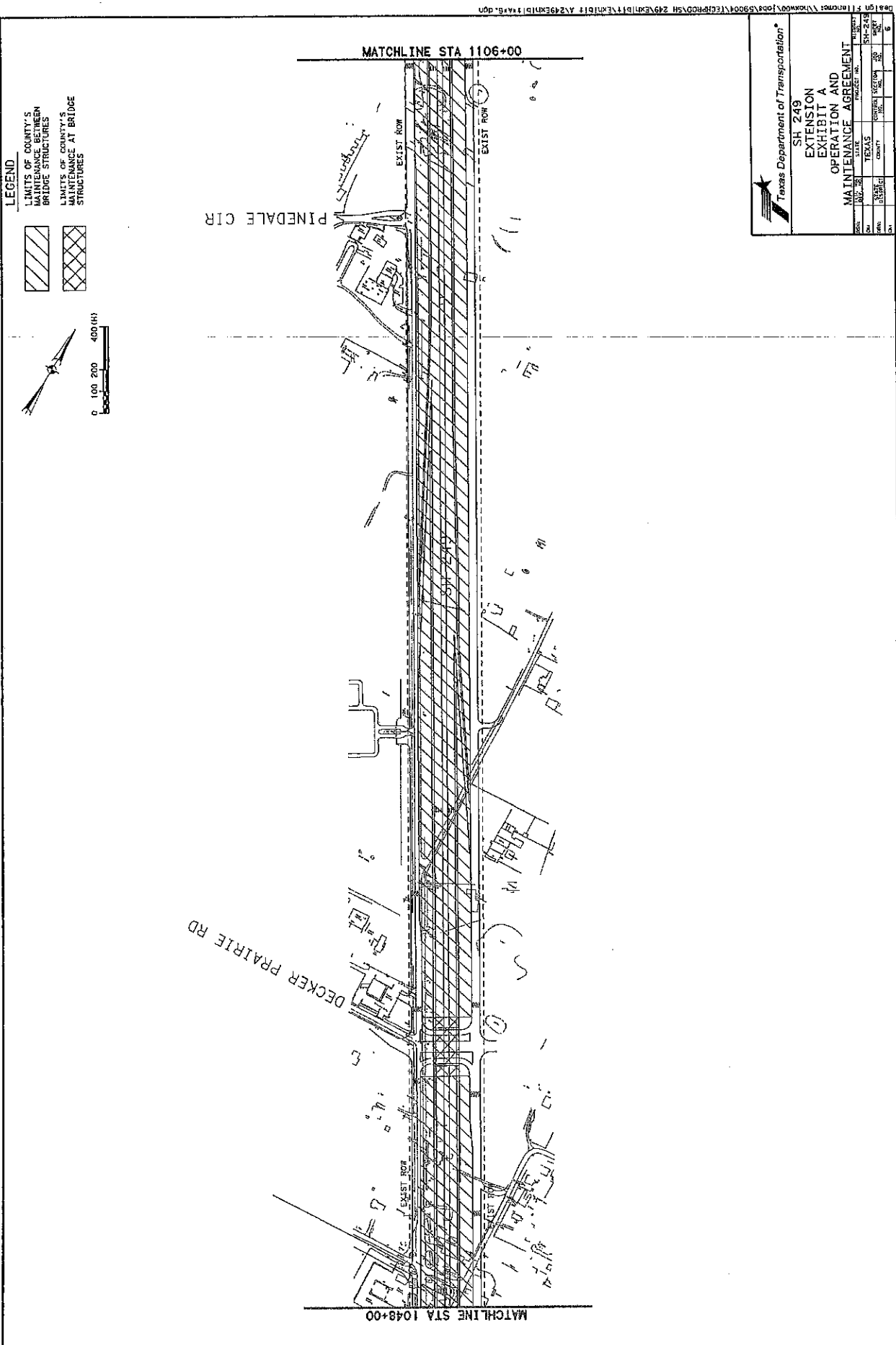

**LEGEND**  
 LIMITS OF COUNTY'S  
 MAINTENANCE BETWEEN  
 BRIDGE STRUCTURES  
 LIMITS OF COUNTY'S  
 MAINTENANCE AT BRIDGE  
 STRUCTURES

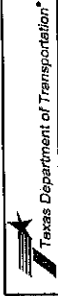
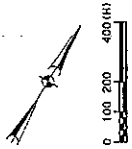
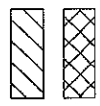

SH 249  
 EXTENSION  
 EXHIBIT A  
 OPERATION AND  
 MAINTENANCE AGREEMENT

NO.	DATE	BY	CHKD.	APPD.	REV.	NO.	DATE	BY	CHKD.	APPD.	REV.

PROJECT NO. \_\_\_\_\_  
 COUNTY \_\_\_\_\_ STATE \_\_\_\_\_  
 COUNTY \_\_\_\_\_ STATE \_\_\_\_\_

Texas Department of Transportation  
 SH 249  
 EXHIBIT A  
 OPERATION AND  
 MAINTENANCE AGREEMENT

SECTION	PROJECT NO.	DATE	BY
001	SH-249	10/28	10/28
002			
003			
004			
005			
006			
007			
008			
009			
010			
011			
012			
013			
014			
015			
016			
017			
018			
019			
020			
021			
022			
023			
024			
025			
026			
027			
028			
029			
030			
031			
032			
033			
034			
035			
036			
037			
038			
039			
040			
041			
042			
043			
044			
045			
046			
047			
048			
049			
050			
051			
052			
053			
054			
055			
056			
057			
058			
059			
060			
061			
062			
063			
064			
065			
066			
067			
068			
069			
070			
071			
072			
073			
074			
075			
076			
077			
078			
079			
080			
081			
082			
083			
084			
085			
086			
087			
088			
089			
090			
091			
092			
093			
094			
095			
096			
097			
098			
099			
100			

MATCHLINE STA 1163+00

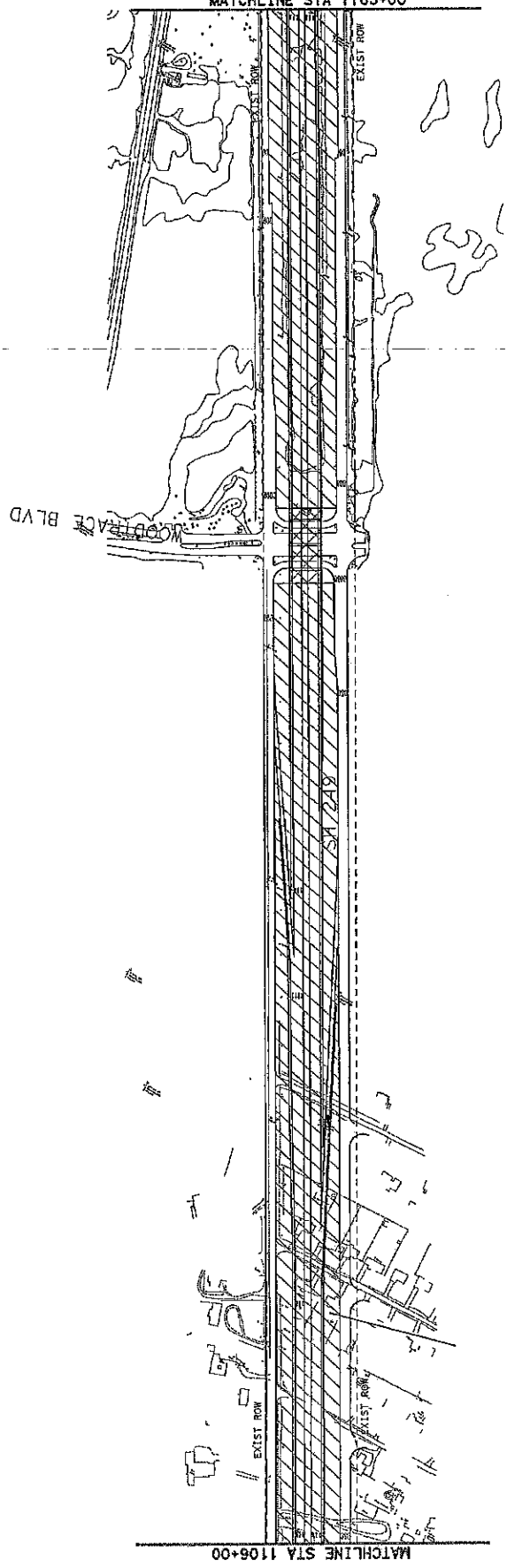

**LEGEND**  
 LIMITS OF COUNTY'S  
 MAINTENANCE BETWEEN  
 BRIDGE STRUCTURES  
 LIMITS OF COUNTY'S  
 MAINTENANCE AT BRIDGE  
 STRUCTURES

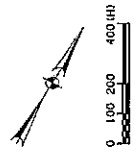
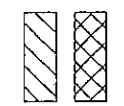

**LEGEND**

- ▨ LIMITS OF COUNTY'S MAINTENANCE BETWEEN BRIDGE STRUCTURES
- ▩ LIMITS OF COUNTY'S MAINTENANCE AT BRIDGE STRUCTURES

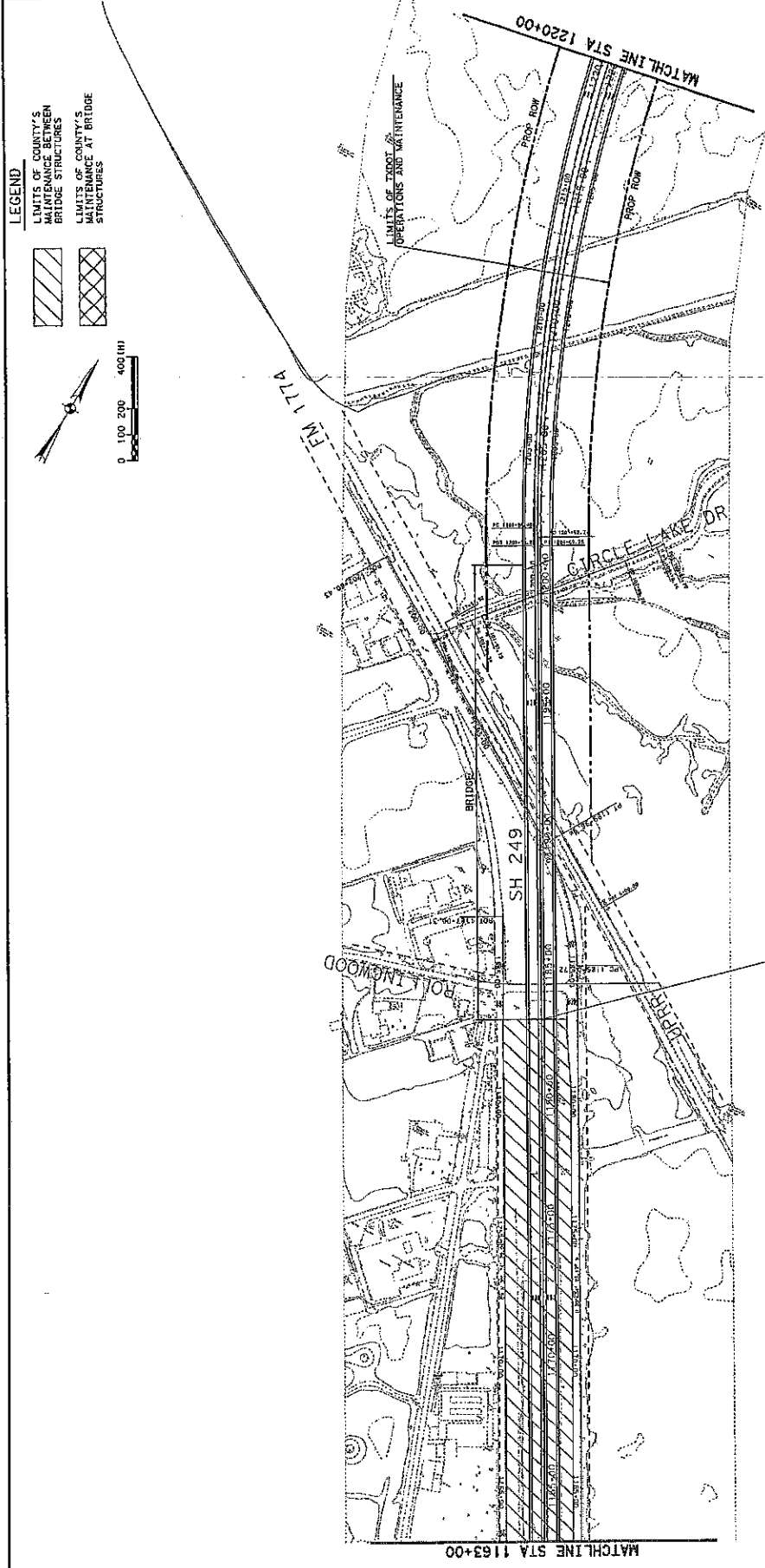
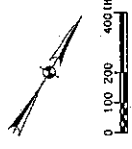



END, MONTGOMERY COUNTY OPERATIONS AND MAINTENANCE.  
 BEGIN EXIST OPERATIONS AND MAINTENANCE PROJECT  
 STA. 1183+05.46

Texas Department of Transportation  
 SH 249  
 EXTENSION  
 EXHIBIT A  
 OPERATION AND  
 MAINTENANCE AGREEMENT

DATE	NOV 2011	STATE	TEXAS	COUNTY	ROBERTSON	SECTION	001	SHEET	10
PROJECT NO.									

**LEGEND**

- 
 LIMITS OF COUNTY'S MAINTENANCE BETWEEN BRIDGE STRUCTURES
- 
 LIMITS OF COUNTY'S MAINTENANCE AT BRIDGE STRUCTURES

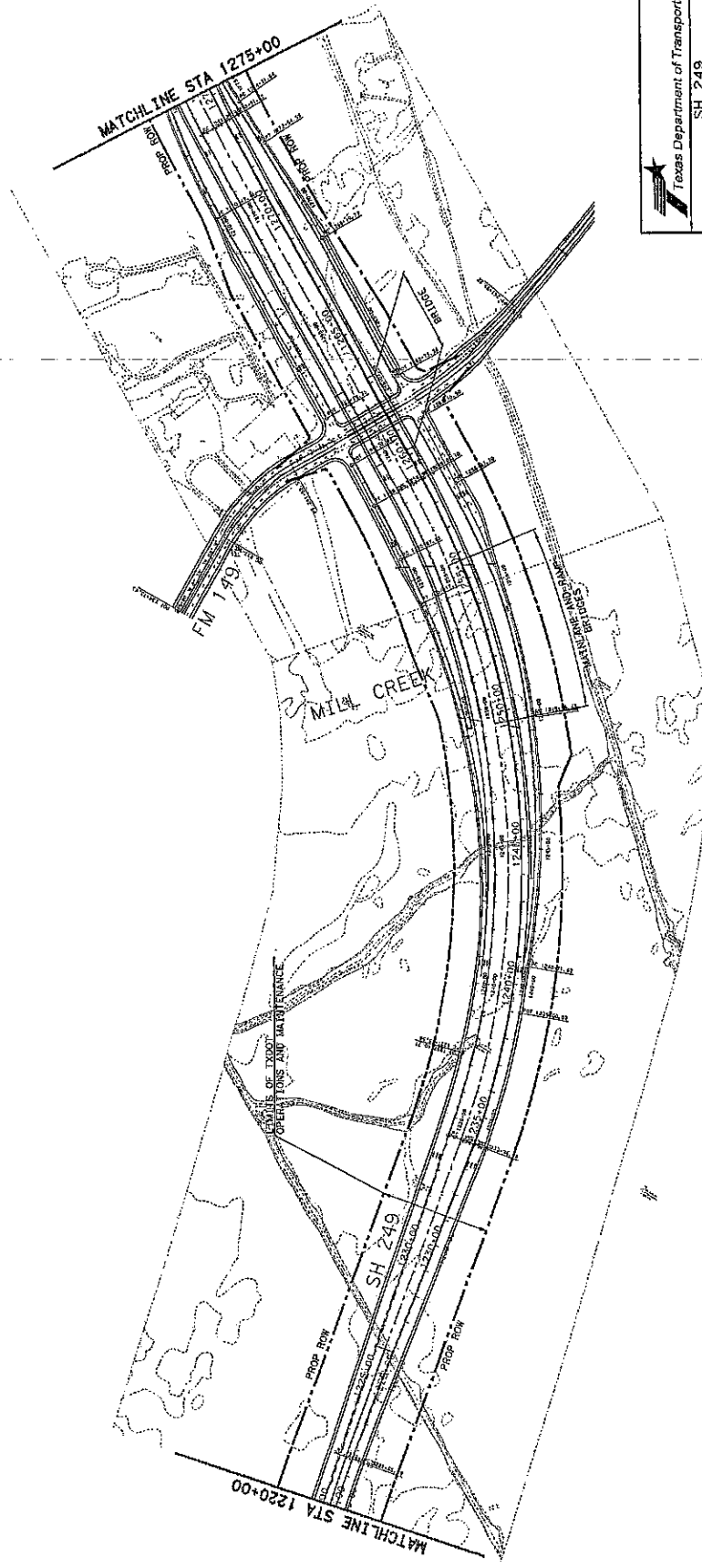
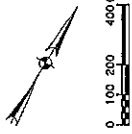

Texas Department of Transportation\*

SH 249  
EXTENSION  
EXHIBIT A  
OPERATION AND  
MAINTENANCE AGREEMENT

PROJECT NO.	STATE	COUNTY	CONTRACT NUMBER	SECTION
SH-249	TEXAS			5

**LEGEND**

- LIMITS OF COUNTY'S MAINTENANCE BETWEEN BRIDGE STRUCTURES
- LIMITS OF COUNTY'S MAINTENANCE AT BRIDGE STRUCTURES

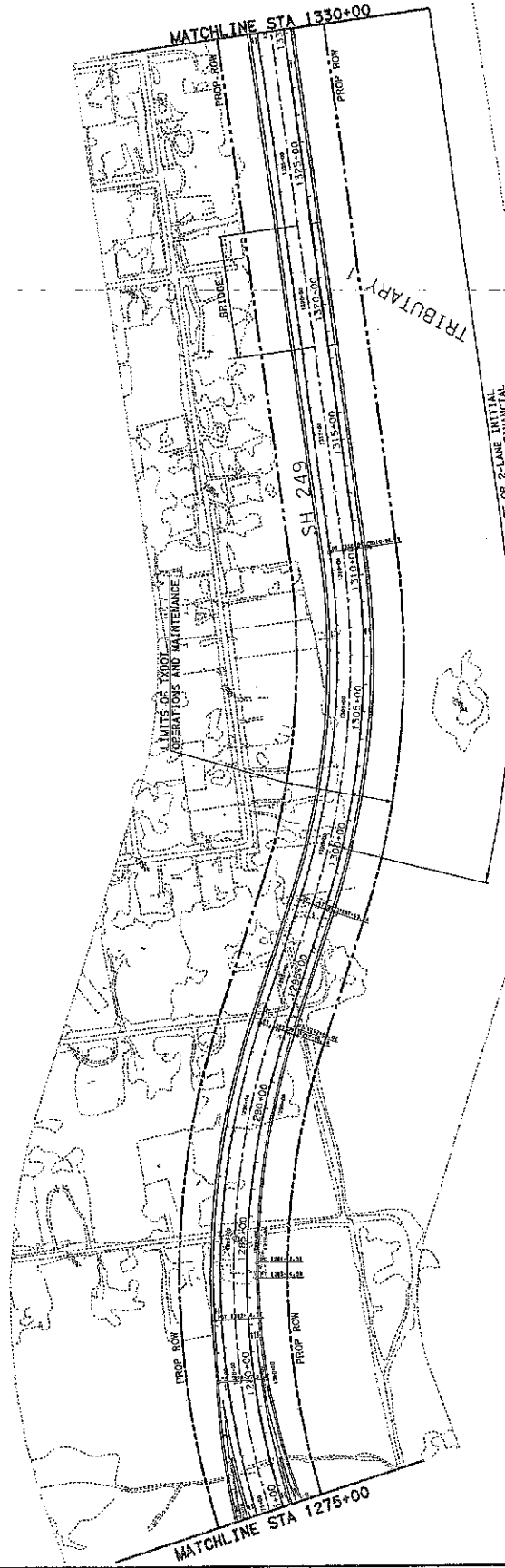
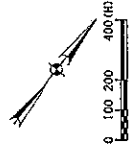
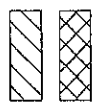

4-LANE UNIMPAVE OR 2-LANE INITIAL ALTERNATIVE DEPENDENT ON FINANCIAL FEASIBILITY ANALYSIS



Texas Department of Transportation

**SH 249  
EXTENSION  
EXHIBIT A  
OPERATION AND  
MAINTENANCE AGREEMENT**

PROJECT NO.	STATE	COUNTY	DISTRICT	SECTION	SHEET NO.	TOTAL SHEETS
249-249	TEXAS	053	11	1	1	1

**LEGEND**  
 LIMITS OF COUNTY'S  
 MAINTENANCE BETWEEN  
 BRIDGE STRUCTURES  
 LIMITS OF COUNTY'S  
 MAINTENANCE AT BRIDGE  
 STRUCTURES

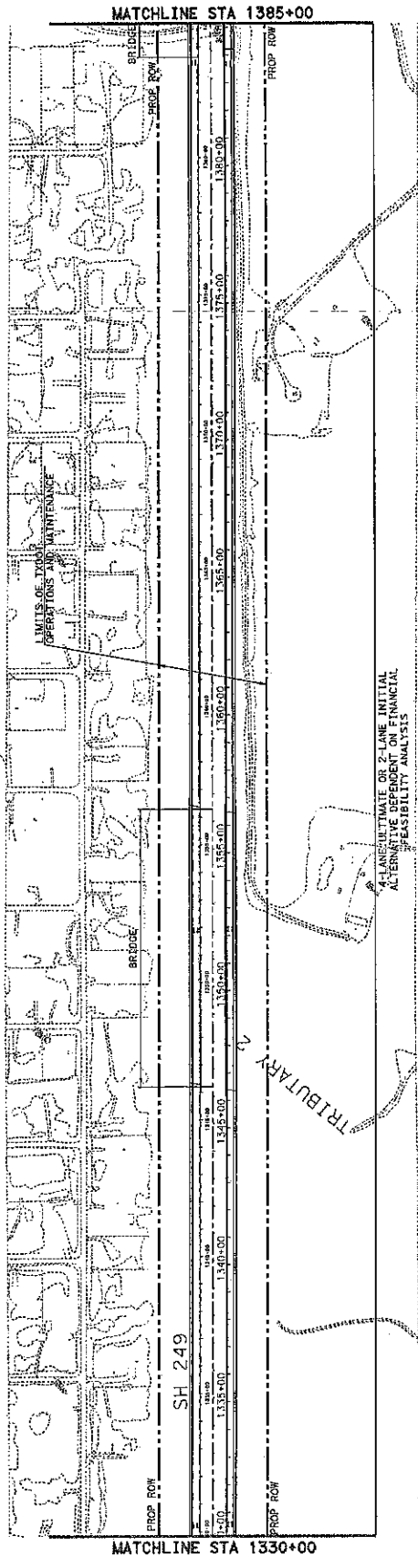
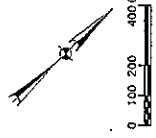
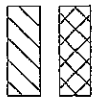

4-LANE/ULTIMATE OR 2-LANE INITIAL  
 ALTERNATE SCENARIOS BY FINANCIAL  
 FEASIBILITY ANALYSIS

Texas Department of Transportation  
 SH 249  
 EXTENSION  
 EXHIBIT A  
 OPERATION AND  
 MAINTENANCE AGREEMENT

DATE	10/1/11	PROJECT NO.	11-111
BY	J. B. BROWN	DESIGNER	11-111
CHECKED	J. B. BROWN	DATE	11/1/11
APPROVED	J. B. BROWN	DATE	11/1/11



**LEGEND**  
 LIMITS OF COUNTY'S  
 MAINTENANCE BETWEEN  
 BRIDGE STRUCTURES  
 LIMITS OF COUNTY'S  
 MAINTENANCE AT BRIDGE  
 STRUCTURES

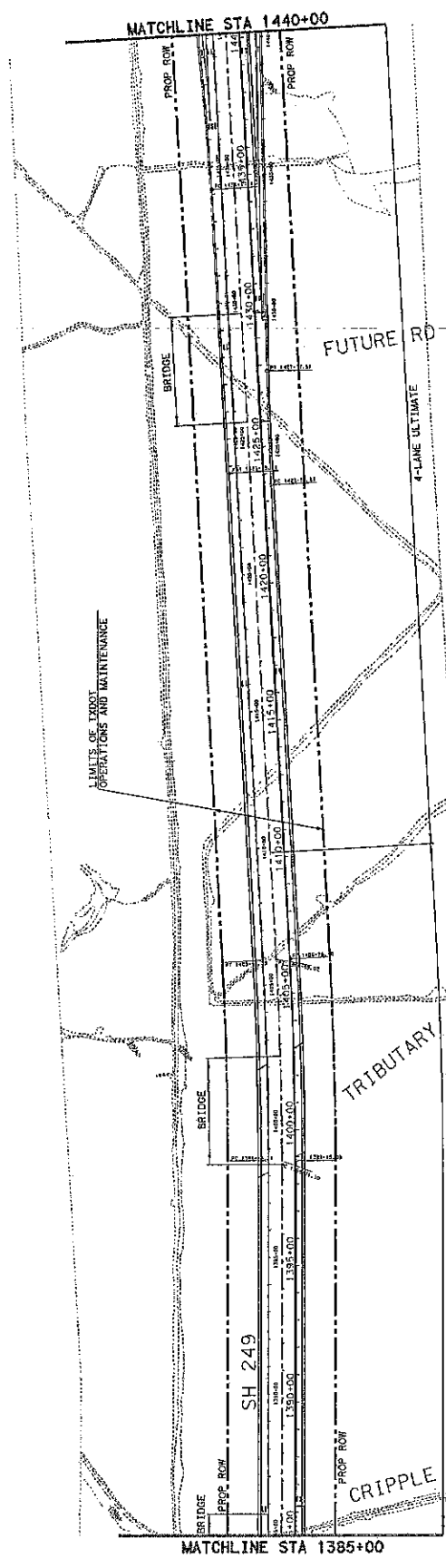
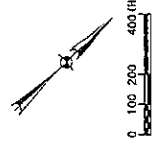
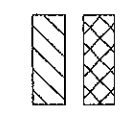

4-LANE ULTIMATE OR 2-LANE INITIAL  
 ALTERNATIVE DEPENDENT ON FINANCIAL  
 FEASIBILITY ANALYSIS

Texas Department of Transportation		SH 249	
EXTENSION		EXHIBIT A	
OPERATION AND		MAINTENANCE AGREEMENT	
DATE	STATE	PROJECT NO.	SECTION
NOV 2015	TEXAS	249-1111	SH-249
NO. OF SHEETS	COUNTY	CONTRACT NO.	SHEET NO.
12	TRAVIS	249-1111	12

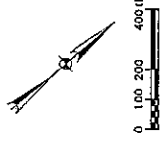

**LEGEND**  
 LIMITS OF COUNTY'S MAINTENANCE BETWEEN BRIDGE STRUCTURES  
 LIMITS OF COUNTY'S MAINTENANCE AT BRIDGE STRUCTURES

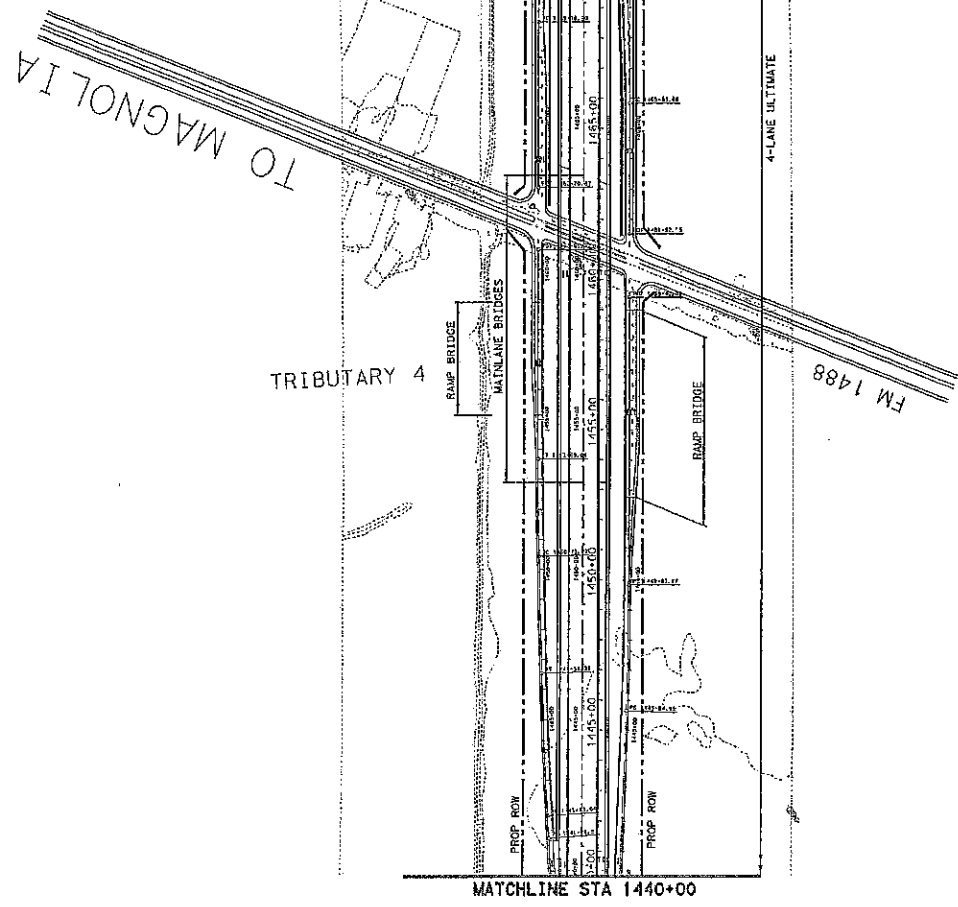
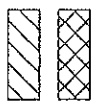

Texas Department of Transportation  
 SH 249  
 EXTENSION  
 EXHIBIT A  
 OPERATION AND  
 MAINTENANCE AGREEMENT

NO.	DATE	BY	REVISION
1	08/11/11	J. B. BROWN	ISSUED FOR BIDDING
2	08/11/11	J. B. BROWN	REVISED TO REFLECT CHANGES
3	08/11/11	J. B. BROWN	REVISED TO REFLECT CHANGES
4	08/11/11	J. B. BROWN	REVISED TO REFLECT CHANGES
5	08/11/11	J. B. BROWN	REVISED TO REFLECT CHANGES
6	08/11/11	J. B. BROWN	REVISED TO REFLECT CHANGES
7	08/11/11	J. B. BROWN	REVISED TO REFLECT CHANGES
8	08/11/11	J. B. BROWN	REVISED TO REFLECT CHANGES
9	08/11/11	J. B. BROWN	REVISED TO REFLECT CHANGES
10	08/11/11	J. B. BROWN	REVISED TO REFLECT CHANGES
11	08/11/11	J. B. BROWN	REVISED TO REFLECT CHANGES
12	08/11/11	J. B. BROWN	REVISED TO REFLECT CHANGES
13	08/11/11	J. B. BROWN	REVISED TO REFLECT CHANGES

**LEGEND**

LIMITS OF COUNTY'S  
MAINTENANCE BETWEEN  
BRIDGE STRUCTURES

LIMITS OF COUNTY'S  
MAINTENANCE AT BRIDGE  
STRUCTURES

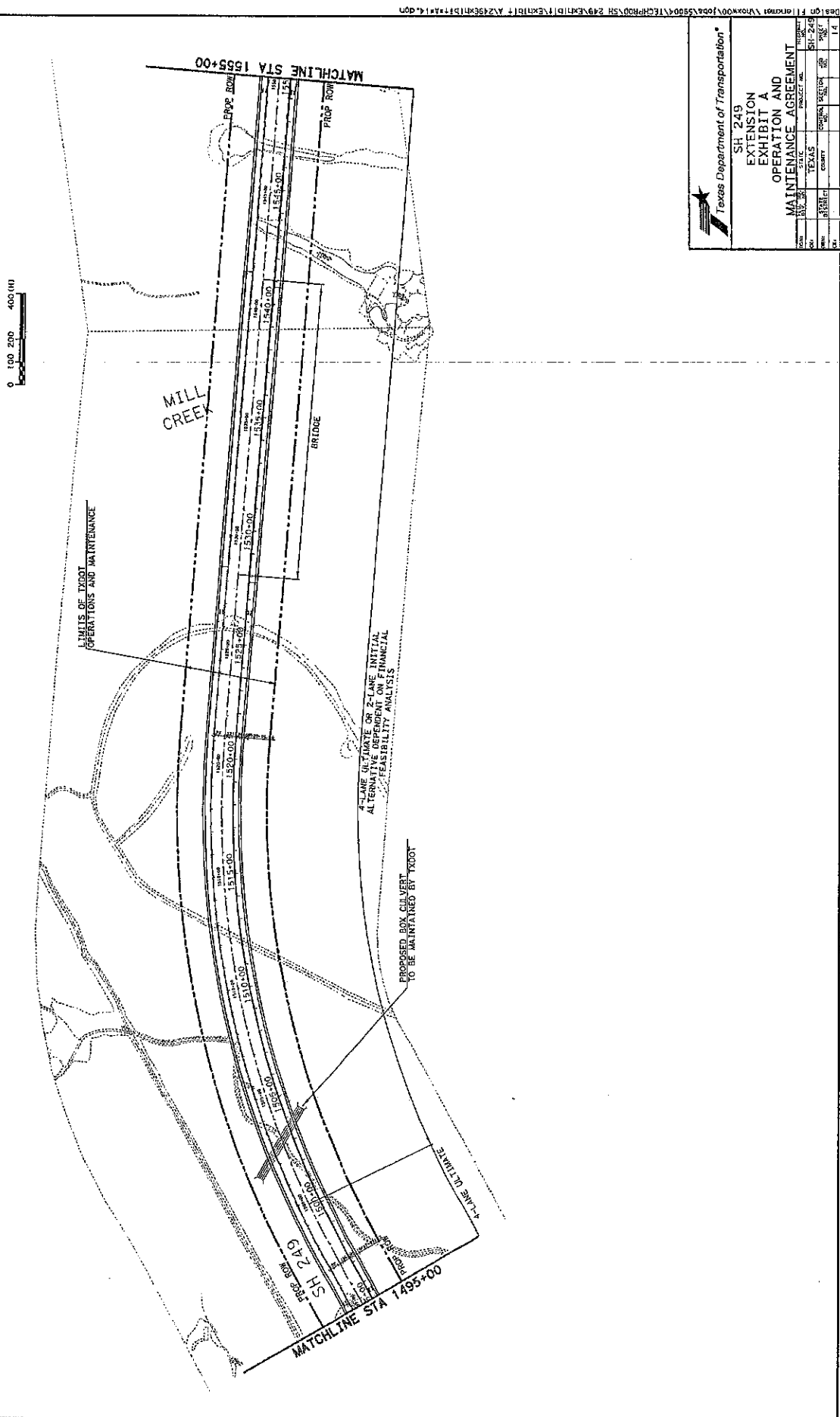
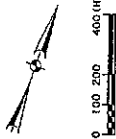
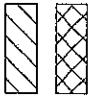

Texas Department of Transportation	
SH 249	
EXTENSION	
EXHIBIT A	
OPERATION AND	
MAINTENANCE AGREEMENT	
DATE	PROJECT NO.
NO.	STATE
SECTION	SECTION
COUNTY	COUNTY
DATE	DATE
SCALE	SCALE
1:4	1:4

**LEGEND**

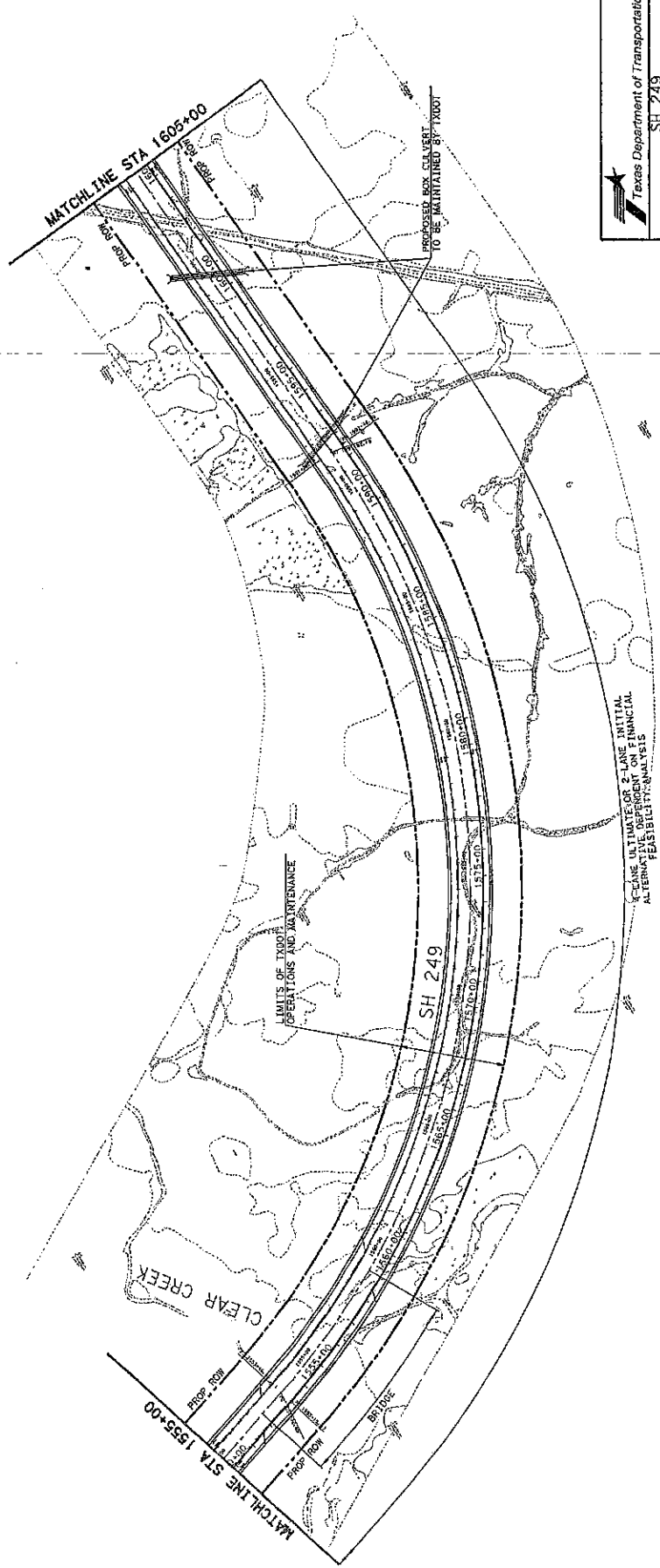
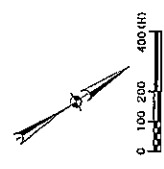
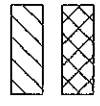

Texas Department of Transportation  
**SH 249**  
 EXTENSION  
 EXHIBIT A  
 OPERATION AND  
 MAINTENANCE AGREEMENT

DATE	BY	STATE	COUNTY	PROJECT NO.	DATE
08/15/15	JLH	TEXAS	TRAVIS	249-15-001	08/15/15

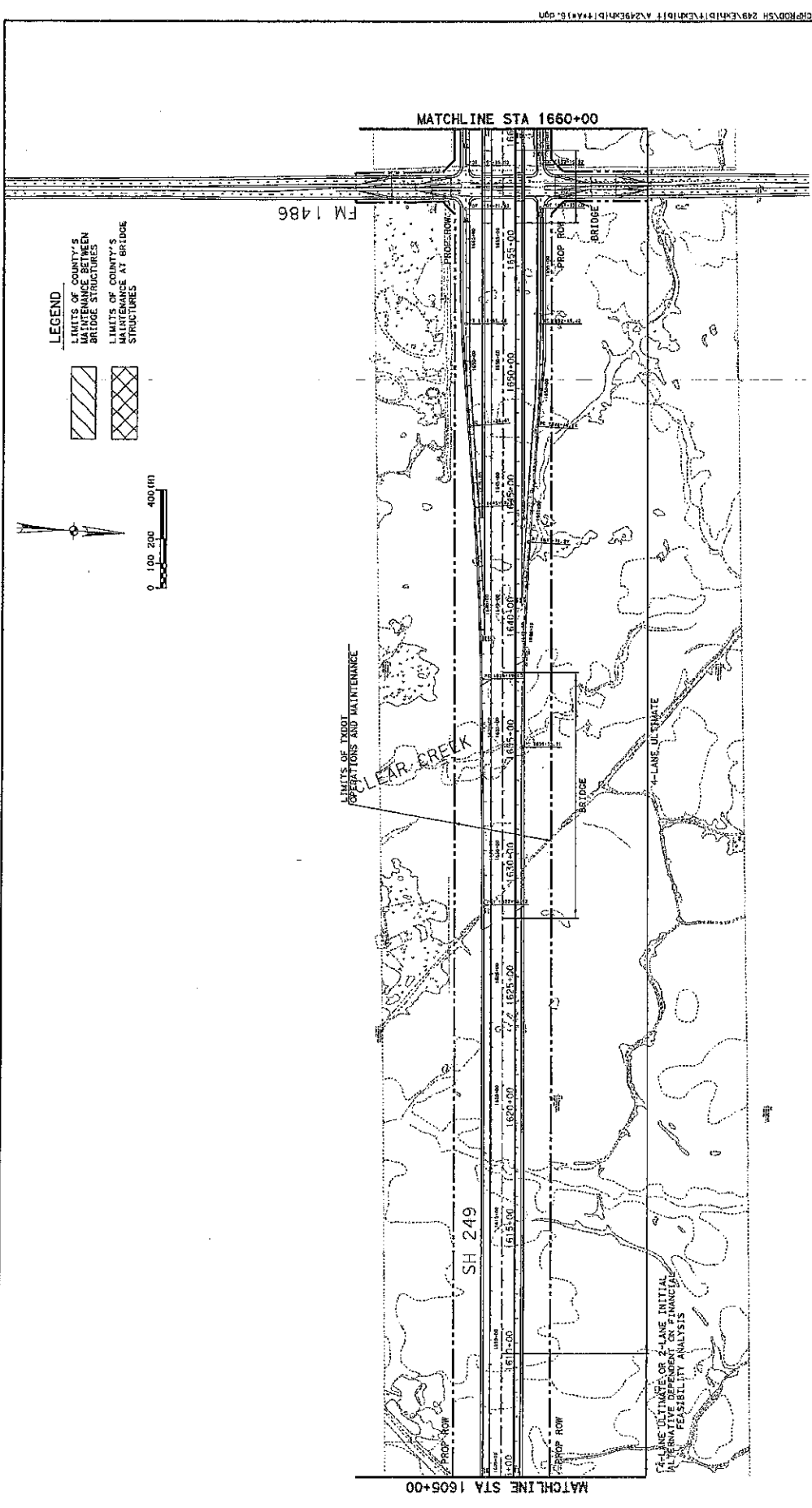

**LEGEND**

LIMITS OF COUNTY'S MAINTENANCE BETWEEN BRIDGE STRUCTURES

LIMITS OF COUNTY'S MAINTENANCE AT BRIDGE STRUCTURES

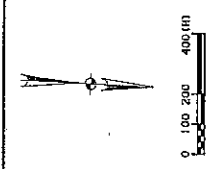

Texas Department of Transportation

SH 249  
EXTENSION  
EXHIBIT A  
OPERATION AND  
MAINTENANCE AGREEMENT

DATE	ISSUED FOR	STATE	PROJECT NO.	SECTION NO.
10/28	10/28	TEXAS	00000001	16
DESIGNER	DRAWN	CHECKED	APPROVED	SCALE

ALTERNATIVE DEPENDENT ON FINANCIAL FEASIBILITY ANALYSIS

LEGEND

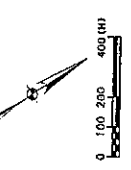
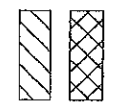

LIMITS OF ROAD OPERATIONS AND MAINTENANCE

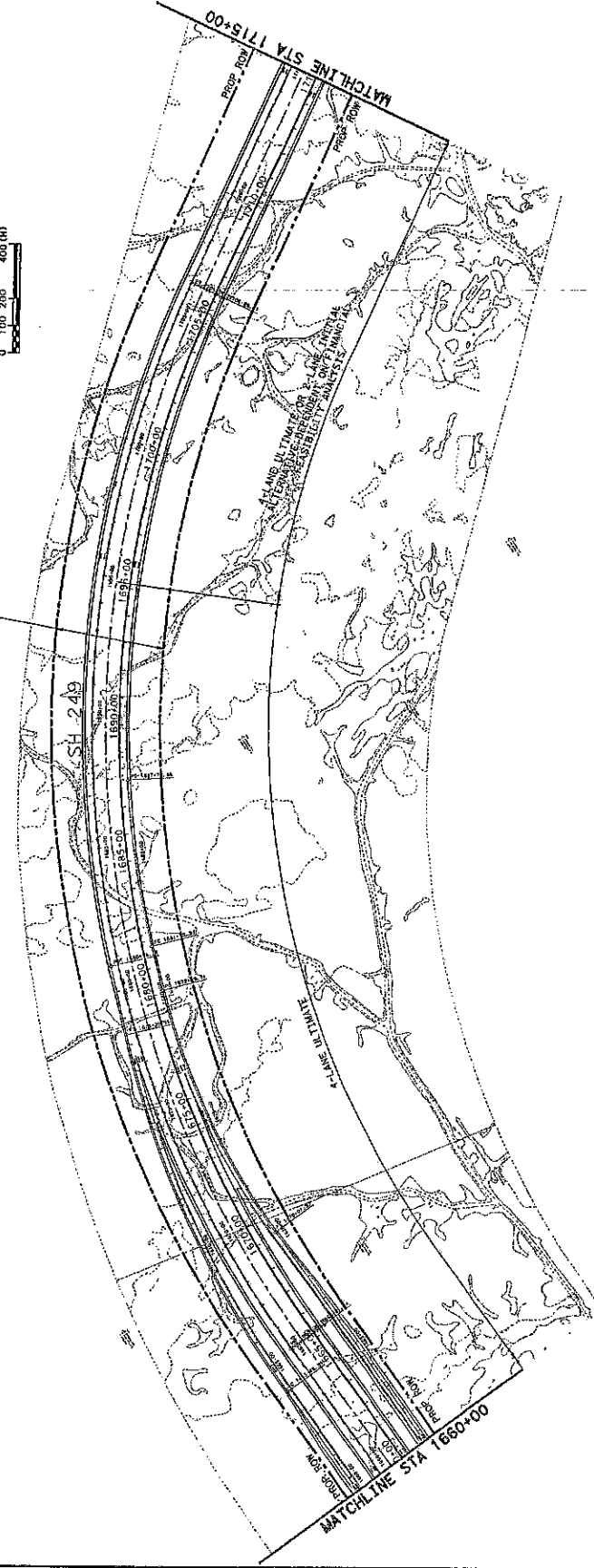

Texas Department of Transportation  
 SH 249  
 EXTENSION  
 EXHIBIT A  
 OPERATION AND  
 MAINTENANCE AGREEMENT

DATE	REV. NO.	DATE	DESCRIPTION	BY	CHK'D BY	APP'D BY

**LEGEND**  
 LIMITS OF COUNTY'S  
 MAINTENANCE BETWEEN  
 BRIDGE STRUCTURES  
 LIMITS OF COUNTY'S  
 MAINTENANCE AT BRIDGE  
 STRUCTURES

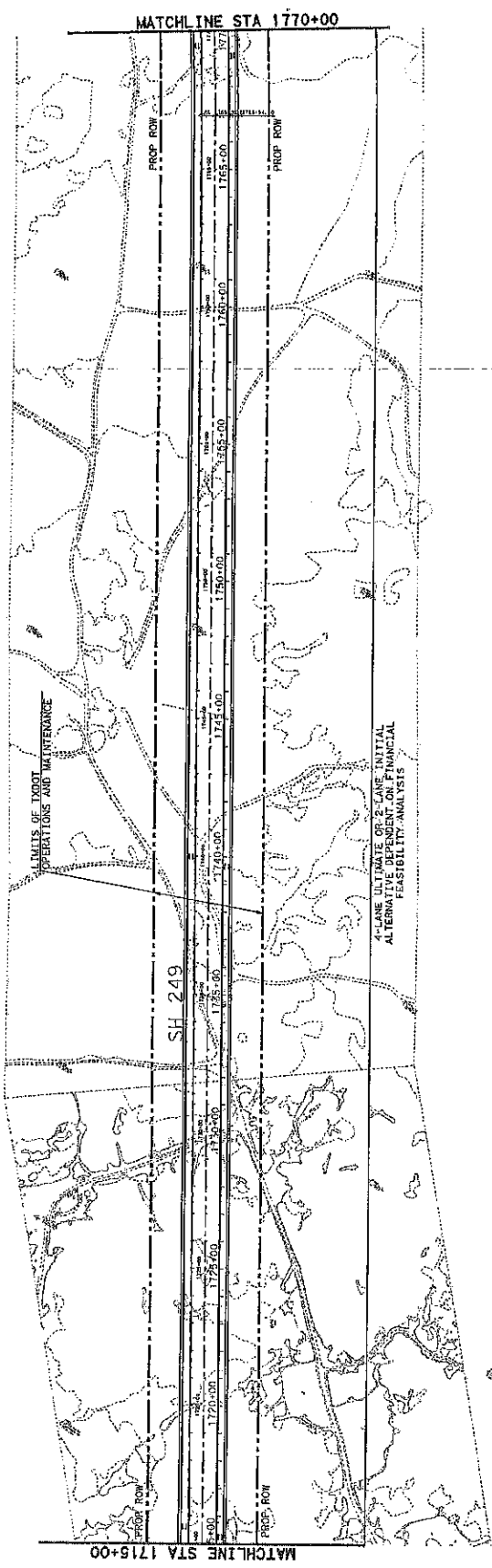
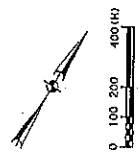
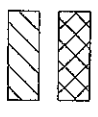

MATCHLINE STA 1770+00

MATCHLINE STA 1715+00

SH 249

LIMITS OF LOGSIT  
 OPERATIONS AND MAINTENANCE

LIMITS OF COUNTY'S  
 MAINTENANCE AT BRIDGE  
 STRUCTURES



Texas Department of Transportation  
 SH 249  
 EXTENSION  
 EXHIBIT A  
 OPERATION AND  
 MAINTENANCE AGREEMENT

STATE	TEXAS	PROJECT NO.	SH 249
COUNTY	...	SECTION	...
CITY	...	SHEET	1B

GRIMES COUNTY  
MONTGOMERY COUNTY

LEGEND

- LIMITS OF COUNTY'S MAINTENANCE BETWEEN BRIDGE STRUCTURES
- LIMITS OF COUNTY'S MAINTENANCE AT BRIDGE STRUCTURES

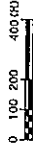

MATCHLINE STA 1825+00

LIMITS OF TRUCK OPERATIONS AND MAINTENANCE

MILL CREEK

SH 249

MATCHLINE STA 1770+00

ALTERNATE ROUTE INITIAL ALTERNATIVE DEPENDENT FINANCIAL FEASIBILITY ANALYSIS



Texas Department of Transportation

SH 249

EXTENSION EXHIBIT A

OPERATION AND MAINTENANCE AGREEMENT

NO.	DATE	BY	REVISION
1			
2			
3			
4			
5			
6			
7			
8			
9			
10			
11			
12			
13			
14			
15			
16			
17			
18			
19			



**LEGEND**

- ▨ LIMITS OF COUNTY'S MAINTENANCE BETWEEN BRIDGE STRUCTURES
- ▩ LIMITS OF COUNTY'S MAINTENANCE AT BRIDGE STRUCTURES

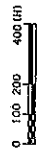

MATCHLINE STA 1880+00

LIMITS OF TxDOT OPERATIONS AND MAINTENANCE

4-LANE ULTIMATE OR 2-LANE INITIAL ALTERNATIVE DESIGN AND FINANCIAL ANALYSIS

MATCHLINE STA 1825+00

SH 249

GRIMES COUNTY  
MONTGOMERY COUNTY



Texas Department of Transportation

SH 249	
EXTENSION	
EXHIBIT A	
OPERATION AND	
MAINTENANCE AGREEMENT	
PROJECT NO.	SH-249
STATE	TEXAS
COUNTY	GRIMES
SECTION	20

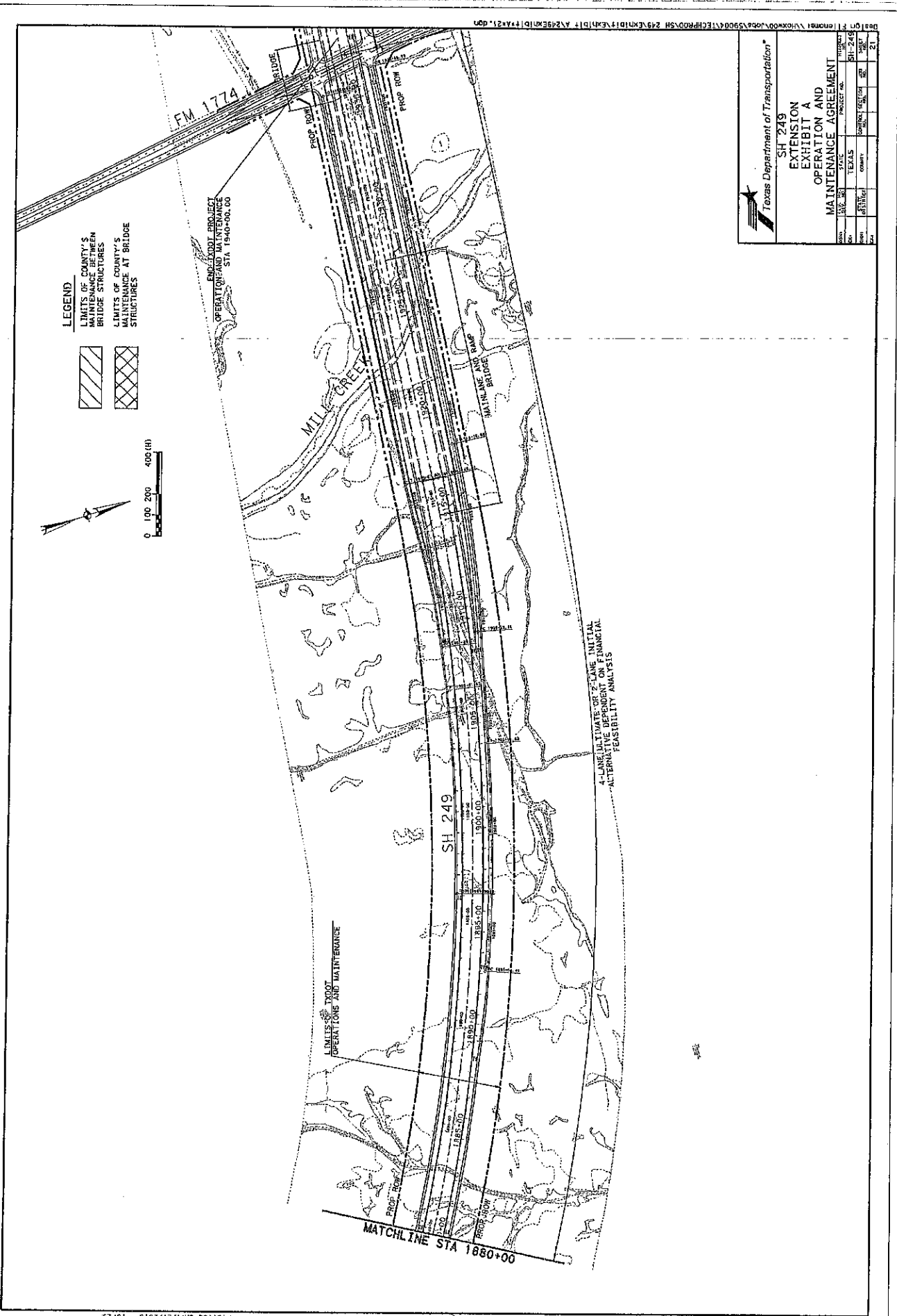

**LEGEND**

LIMITS OF COUNTY'S MAINTENANCE BETWEEN BRIDGE STRUCTURES

LIMITS OF COUNTY'S MAINTENANCE AT BRIDGE STRUCTURES

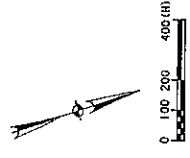

Texas Department of Transportation

SH 249

EXTENSION

EXHIBIT A

OPERATION AND MAINTENANCE AGREEMENT

DATE	BY	PROJECT NO.	SHEET NO.
10/15/15	JLW	249P10F5900441X17	21
STATE	COUNTY	DISTRICT	SECTION
TEXAS		10	

Exhibit "B"

[to be attached]

**RESOLUTION AND ORDER APPROVING CONSTRUCTION, OPERATION AND  
MAINTENANCE AGREEMENT BETWEEN MONTGOMERY COUNTY, MONTGOMERY  
COUNTY TOLL ROAD AUTHORITY AND TXDOT FOR SH 249**

STATE OF TEXAS                                   §

COUNTY OF MONTGOMERY                   §

On the 26<sup>th</sup> day of January, 2015, at a duly posted and called meeting of the Commissioners Court of Montgomery County, Texas, on motion of Commissioner Judge Doyal, seconded by Commissioner Meador, duly put and carried:

WHEREAS, Montgomery County ("County") and the Texas Department of Transportation ("TxDOT") have been working in partnership to develop the State Highway 249 corridor in Montgomery County, which is a designated part of the State Highway System;

WHEREAS, on December 13, 2007, the Texas Transportation Commission (hereinafter called the "Commission") passed Minute Order 111168, designating a portion of State Highway 249 from Spring Cypress Road in Harris County to FM 1774 in Montgomery County as a future toll facility;

WHEREAS, the County and TxDOT have been engaged in the planning and development of a proposed toll facility in the State Highway 249 corridor from the Montgomery/Harris county line to FM 1774 just north of the Montgomery/Grimes county line (hereinafter called the "SH 249 Project"), with the SH 249 Project scope and alignment to be determined in accordance with the environmental process and analysis of financial feasibility;

WHEREAS, Chapter 373, Transportation Code, authorizes the County to construct, operate and maintain toll road facilities, and authorizes TxDOT to make available state highway right-of-way to be used for such purposes, provided that the County pay an amount to reimburse TxDOT's actual costs to acquire the right-of-way, and authorizes the Commission or TxDOT to waive the County's reimbursement obligation;

WHEREAS, pursuant to that authority, the County will finance, design, construct, operate and maintain the segment of the SH 249 Project between the Harris County line and FM 1774 in Pinehurst (hereinafter called the "County Project"), with the County Project to be constructed on State right-of-way (hereinafter called the "State Highway Facility"), as more particularly described in Exhibit "A" to the Agreement, a copy of which is attached as Exhibit "1" (hereinafter the "Agreement");

WHEREAS, TxDOT will finance, design, construct, operate and maintain the segment of the Project between FM 1774 in Pinehurst and FM 1774 in Grimes County near Todd Mission (hereinafter called the "TxDOT Project"), as more particularly described in Exhibit "1A" to the Agreement;

WHEREAS, TxDOT and the County acknowledge that the TxDOT Project is not suitable to being delivered under a concession agreement, and that the TxDOT Project will be delivered using the design-build or design-bid-build delivery methodology;

WHEREAS, the development and construction of the SH 249 Project is critical to the Greater Houston region and essential for the future movement of people and goods through Grimes, Montgomery, Harris, and Brazos counties, and will bring jobs and economic development to the County and relieve congestion in the region;

WHEREAS, TxDOT has determined that the State of Texas will receive substantial benefits from toll road projects to be constructed, operated and maintained by the County, and as provided in this Agreement authorizing use of the State Highway Facility by the County for such purposes;

NOW THEREFORE, BE IT ORDERED BY THE COMMISSIONERS COURT OF MONTGOMERY COUNTY, TEXAS, the following:

1. The Construction, Operation and Maintenance Agreement between Montgomery County, the Montgomery County Toll Road Authority and TxDOT in the form attached to this Resolution is approved (the "Agreement"); and
2. Craig Doyal, County Judge of Montgomery County, Texas is hereby appointed and authorized to execute the Agreement in multiple counterparts; and
3. Craig Doyal, County Judge of Montgomery County, Texas shall be authorized to act on behalf of Montgomery County, Texas, at the closing of the transaction, to deliver and sign documents, and accept receipt of all documents required to complete the Agreement.

PASSED AND APPROVED this 26<sup>th</sup> day of January, 2015.

MONTGOMERY COUNTY, TEXAS

  
CRAIG DOYAL, COUNTY JUDGE

  
MIKE MEADOR, COMMISSIONER, PCT. 1

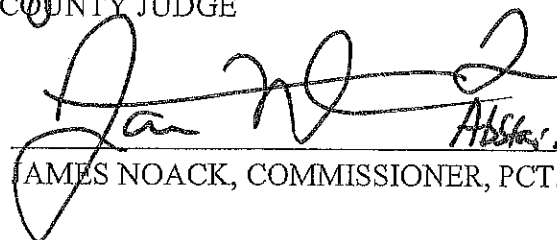
  
JAMES NOACK, COMMISSIONER, PCT. 3

  
CHARILE RILEY, COMMISSIONER, PCT. 2

  
JIM CLARK, COMMISSIONER, PCT. 4



2591 N. EARL RUDDER FREEWAY | BRYAN, TEXAS 77803-5190 | (979) 778-2165 | WWW.TXDOT.GOV

October 14, 2014

The Honorable Betty Shiflett  
Judge of Grimes County  
100 Main Street  
Anderson, Texas 77830

SH 249  
Grimes County  
0917-17-069

Dear Judge Shiflett:

Please find attached the executed Memorandum of Understanding (MOU) between the City of Navasota and the Texas Department of Transportation (TxDOT) regarding the development of SH 249 in Grimes County. This MOU formalizes the cooperation between TxDOT, the City and Grimes County to incorporate the principles and commitments previously determined by our representatives.

We greatly appreciate you and your staff's efforts to assist TxDOT in delivering a much needed project for Grimes County, the Bryan District and State of Texas. If you have any questions, please contact me at 979-778-9714.

Sincerely,

Catherine W. Hejl, P.E.  
Bryan District Engineer

cc: Ben Leman  
Judge Elect – Grimes County

Attachment

## MEMORANDUM OF UNDERSTANDING

**THIS MEMORANDUM OF UNDERSTANDING (“MOU”),** by and between the **TEXAS DEPARTMENT OF TRANSPORTATION**, an agency of the State of Texas, as authorized by the Texas Transportation Commission, hereinafter identified as “TxDOT,” and the **CITY OF NAVASOTA**, a political subdivision of the State of Texas, hereinafter identified as the “City,” is executed to be effective this \_\_\_\_ day of \_\_\_\_\_, 2014.

### RECITALS

The City and TxDOT have been working in partnership to identify and develop critical infrastructure in the City and Grimes County;

The City, Grimes County, and TxDOT have been engaged in the planning and development of a proposed toll facility in the State Highway 249 corridor from FM 1774 just north of the Montgomery County line to a point on State Highway 105 near FM 1748, with the exact alignment to be determined in accordance with environmental process (the “SH 249 Toll Project”);

The development and construction of the State Highway 249 tolled corridor is critical to the region and essential for the future movement of people and goods through Grimes, Montgomery, Harris and Brazos Counties;

Construction of the SH 249 Toll Project will bring jobs and economic development to the City and Grimes County, and local connectivity to State Highway 249 will accelerate economic development for the City and Grimes County;

A memorandum of understanding is desirable to clarify the relationships between TxDOT and the City in connection with development, construction, funding, operation and maintenance of the SH 249 Toll Project; and

On September 22, 2014, the City Council of the City authorized the City to enter into the MOU;

**NOW, THEREFORE,** TxDOT and the City agree as follows:

#### **1. Responsibility for Project Development and Delivery.**

- a. TxDOT will plan, develop, finance, and construct the SH 249 Toll Project. TxDOT will invest \$100 million to pay costs of the SH 249 Toll Project. The City acknowledges its interest in the future development of the SH 249 Toll Project in Grimes County and will work cooperatively with TxDOT in on-going planning, environmental and project development efforts.

- b. TxDOT will plan and acquire right-of-way for a 4 lane divided, access controlled, toll road with non-tolled frontage roads. TxDOT will initially construct a 2-lane tolled facility with passing lanes where appropriate.
- c. TxDOT will be responsible for the procurement of a design-build developer for the SH 249 Toll Project and will have responsibility for project design and construction in accordance with the design-build development agreement (the "Development Agreement") with the developer selected through TxDOT's procurement process (the "Developer"); construction oversight and management; right-of-way acquisition; and obtaining and maintaining all governmental approvals related to delivery of the SH 249 Toll Project. TxDOT consultants will assist TxDOT employees in carrying out TxDOT's responsibilities. As required by state law, the state highway facilities that are the subject of the Development Agreement are public property and will be owned by TxDOT.
- d. TxDOT will, upon completion of the SH 249 Toll Project, initiate the process to designate and sign State Highway 249 (concurrent with State Highway 105) from the point it intersects State Highway 105, west along the State Highway 105 alignment to the point that it connects to State Highway 6.
- e. TxDOT will work with the City and Grimes County to assure that adequate emergency access for first responders to and across the toll facilities is provided for the safety of Grimes County citizens.
- f. The City will continue to assist in providing input to TxDOT related to the SH 249 Toll Project.

## **2. Responsibility for Project Operation and Maintenance.**

- a. TxDOT will be responsible for all road operations and maintenance of the SH 249 Toll Project, and will be responsible for toll collection and toll operations. The SH 249 Toll Project will be operated as a part of the state highway system.
- b. The Texas Transportation Commission (Commission) will set the toll rates for the SH 249 Toll Project. Toll revenues will be used to reimburse construction costs and repay any debt issued to pay construction costs, and to pay the costs of operation and maintenance of the SH 249 Toll Project.
- c. After the costs of operation and maintenance and any debt is paid, any excess revenues will be used to upgrade the toll road, upgrade that portion of State Highway 249 that runs concurrent with State Highway 105, and build interchanges and non-contiguous frontage roads along both sections.
- d. When/if excess toll revenues become available, TxDOT will work with the City and Grimes County to identify, prioritize, and provide interchanges and non-contiguous frontage roads along State Highway 249 and/or upgrade other state facilities adjacent



to the corridor within Grimes County where growth and development prove that they are needed.

- e. TxDOT may, at its discretion, waive required toll collection on the SH 249 Toll Project during reconstruction activities or at other times when operationally necessary or in accordance with the free passage policy adopted by the Commission.

### **3. Payment of Project Costs and other Costs.**

- a. TxDOT will contribute \$100 million to pay costs of the SH 249 Toll Project and will be responsible for the payment of any additional costs necessary to design and construct the SH 249 Toll Project. TxDOT's obligation to pay such costs is subject to legislative appropriation.
- b. In the event toll revenues do not cover the total annual operations and maintenance expenses of the SH 249 Toll Project, including the costs of toll collection and toll operations, TxDOT will be responsible for payment of unpaid amounts.
- c. Within one year of the receipt of the Environmental Approval for the SH 249 Toll Project, TxDOT will initiate a planning and environmental study to expand State Highway 105 where it runs concurrent with State Highway 249 to a 4 lane divided, non-tolled facility, ultimately with access control, and with frontage roads and an upgraded connection into State Highway 6. The purpose of this expansion is to accommodate the long term traffic projections along the State Highway 249 corridor, and to avoid the need to construct an alternate route bypassing the City. In the event TxDOT determines there is a need for an improved connection for State Highway 105/State Highway 249 east of the City to State Highway 6, TxDOT will work with the City Council and the Grimes County Commissioners Court to identify the alternatives to be considered.
- d. TxDOT will partner with the City and Grimes County to incorporate economic considerations or initiatives (e.g., utility corridors, extra conduit for fiber) that can serve to provide a greater standard of living or provide an economic incentive for citizens of Grimes County to the degree that state law and TxDOT policy allows and to the degree that such considerations are identified and can be designed into the SH 249 Toll Project.
- e. Should the City desire to accelerate upgrades to that portion of State Highway 249 that runs concurrent to State Highway 105, or the construction of interchanges and non-contiguous frontage roads prior to excess toll revenues becoming available, the City will work with TxDOT and Grimes County to identify local funding sources to help fund these improvements.

4. **Termination.** This MOU may be terminated upon the occurrence of any of the following conditions:
  - a. by written, mutual agreement and consent of the parties;
  - b. by either party, upon the failure of the other party to fulfill the obligations as set forth in this MOU; or
  - c. by satisfactory completion of all responsibilities and obligations described herein.
5. **Remedies.** This MOU shall not be considered as specifying the exclusive remedy for any default, but either party may avail itself of any remedy existing at law or in equity, and all remedies shall be cumulative.
6. **Notices.** All notices to either party by the other required under this MOU shall be delivered personally or sent by certified or registered U.S. Mail, postage prepaid, addressed to such party at the following respective addresses:

City of Navasota  
200 E. McAlpine Street  
Navasota, Texas 77868  
Attention: City Manager

Texas Department of Transportation  
Bryan District  
2591 North Earl Rudder Freeway  
Bryan, Texas 77803  
Attention: District Engineer

7. **Relationship of the Parties.** Except for the limited purposes expressly stated herein, nothing in this MOU shall be deemed or construed by the parties, or by any third party, as creating the relationship of principal and agent between TxDOT and the City. Neither TxDOT nor the City waives, relinquishes, limits or conditions its governmental immunity or any other right to avoid liability which it otherwise might have to third parties.
8. **Sole Benefit.** This MOU is entered into for the sole benefit of TxDOT and the City and their respective successors and permitted assigns. Nothing in this MOU or in any approval subsequently provided by either party hereto shall be construed as creating any liability in favor of any third party or parties against either TxDOT or the City, relieving any third party or parties from any liabilities of such third party or parties to TxDOT or the City, or giving any benefits, rights, remedies, or claims to any other public or private person, firm, corporation or other entity.
9. **Authorization.** Each party to this MOU represents to the other that it is fully authorized to enter into this MOU and to perform its obligations hereunder, and that no waiver, consent, approval, or authorization from any third party is required to be obtained or made in connection with the execution, delivery, or performance of this MOU. Each

signatory on behalf of TxDOT and the City, as applicable, is fully authorized to bind that entity to the terms of this MOU.

**IN WITNESS WHEREOF**, TxDOT and the City have executed this MOU by two (2) multiple counterparts on the dates shown herein below, effective on the date listed above.

**CITY OF NAVASOTA**

By:   
Bert Miller  
Mayor

Date: 9-24-14

**TEXAS DEPARTMENT OF  
TRANSPORTATION**

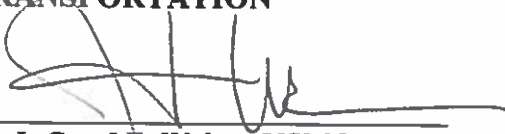
By:   
LtGen J.F. Weber, USMC (Ret)  
Executive Director

Date: 10/14/14

Texas Department of Transportation  
Technical Provisions  
for  
SH 249 Extension

Attachment 6-1  
Utility Adjustment Forms

February 9, 2017



## DB Contractor's Utility Manager

### Utility No Conflict Sign-Off Form

Utility Manager: \_\_\_\_\_  
 Date plans received: \_\_\_\_\_  
 Utility Company: \_\_\_\_\_  
 Assembly "U" number: \_\_\_\_\_  
 Type of Utilities: \_\_\_\_\_  
 Date on Utility's plans: \_\_\_\_\_ No. of sheets in Utility's plans: \_\_\_\_\_

I, \_\_\_\_\_, the Utility Manager (UM) working on behalf of the DB Contractor (\_\_\_\_\_) certify that a review of the above referenced Utility Plans concerning the proposed highway improvements on the \_\_\_\_\_ has been completed and have not identified any conflicts between the Utility's proposed relocation and any existing and/or proposed Utilities.

The proposed Utility Plans conform to Title 43 of the Texas Administrative Code, Section 21.31 – 21.56 of the Utility Accommodation Rules.

Check box if any areas of concern and insert comments below:

**Utility Manager:** \_\_\_\_\_  
 (UM) (Signature) Date

\_\_\_\_\_  
 (Print Name)

**Utility Design Coordinator:** \_\_\_\_\_  
 (UDC) (Signature) Date

\_\_\_\_\_  
 (Print Name)

**Utility Coordination Firm:** \_\_\_\_\_  
 (Print Name)

County: \_\_\_\_\_  
ROW CSJ No.: \_\_\_\_\_  
Const. CSJ No.: \_\_\_\_\_  
Highway: \_\_\_\_\_  
Fed. Proj. No.: \_\_\_\_\_  
Limits: \_\_\_\_\_ to \_\_\_\_\_

**EXHIBIT A**

**PLANS, SPECIFICATIONS, COST ESTIMATES AND ALLOCATION**

County: \_\_\_\_\_  
ROW CSJ No.: \_\_\_\_\_  
Const. CSJ No.: \_\_\_\_\_  
Highway: \_\_\_\_\_  
Fed. Proj. No.: \_\_\_\_\_  
Limits: \_\_\_\_\_ to \_\_\_\_\_

**EXHIBIT B**

**UTILITY ADJUSTMENT AGREEMENT AMENDMENT  
(SPD ROW-U-UAAA-DM)**

County: \_\_\_\_\_  
ROW CSJ No.: \_\_\_\_\_  
Const. CSJ No.: \_\_\_\_\_  
Highway: \_\_\_\_\_  
Fed. Proj. No.: \_\_\_\_\_  
Limits: \_\_\_\_\_ to \_\_\_\_\_

**EXHIBIT A**

**PLANS, SPECIFICATIONS, COST ESTIMATES AND ALLOCATION**



County: \_\_\_\_\_  
ROW CSJ No.: \_\_\_\_\_  
Const. CSJ No.: \_\_\_\_\_  
Highway: \_\_\_\_\_  
Fed. Proj. No.: \_\_\_\_\_  
Limits: \_\_\_\_\_ to \_\_\_\_\_

**EXHIBIT B**

**UTILITY ADJUSTMENT AGREEMENT AMENDMENT  
(SPD ROW-U-UAAA-OM)**



County: \_\_\_\_\_  
ROW CSJ No.: \_\_\_\_\_  
Const. CSJ No.: \_\_\_\_\_  
Highway: \_\_\_\_\_  
Fed. Proj. No.: \_\_\_\_\_  
Limits: \_\_\_\_\_ to \_\_\_\_\_

**EXHIBIT C**

**STATEMENT COVERING CONTRACT WORK**



**STATEMENT COVERING UTILITY CONSTRUCTION CONTRACT WORK**

(AS APPEARING IN ESTIMATE)

U-No. \_\_\_\_\_

District: \_\_\_\_\_

County: \_\_\_\_\_

ROW CSJ No.: \_\_\_\_\_

Federal Project No.: \_\_\_\_\_

Highway No.: \_\_\_\_\_

I, \_\_\_\_\_, a duly authorized and qualified representative of \_\_\_\_\_, hereinafter referred to as **Owner**, am fully cognizant of the facts and make the following statements in respect to work which will or may be done on a contract basis as appears in the estimate to which this statement is attached.

It is more economical and/or expedient for **Owner** to contract this adjustment, or **Owner** is not adequately staffed or equipped to perform the necessary work on this project with its own forces to the extent as indicated on the estimate.

**Procedure to be Used in Contracting Work**

- A. Solicitation for bids is to be accomplished through open advertising and contract is to be awarded to the lowest qualified bidder who submits a proposal in conformity with the requirements and specifications for the work to be performed.
- B. Solicitation for bids is to be accomplished by circulating to a list of pre-qualified contractors or known qualified contractors and such contract is to be awarded to the lowest qualified bidder who submits a proposal in conformity with the requirements and specifications for the work to be performed. Such presently known contractors are listed below:
  - 1. \_\_\_\_\_
  - 2. \_\_\_\_\_
  - 3. \_\_\_\_\_
  - 4. \_\_\_\_\_
  - 5. \_\_\_\_\_
- C. The work is to be performed under an existing continuing contract under which certain work is regularly performed for **Owner** and under which the lowest available costs are developed. (If only part of the contract work is to be done under an existing contract, give detailed information by attachment hereto.)
- D. The utility proposes to contract outside the foregoing requirements and therefore evidence in



support of its proposal is attached to the estimate in order to obtain the concurrence of the State, and the Federal Highway Administration Division Engineer where applicable, prior to taking action thereon (approval of the agreement shall be considered as approval of such proposal).

- E. The utility plans and specifications, with the consent of the State, will be included in the construction contract awarded by the State.

\_\_\_\_\_  
[Signature of Officer/Representative]

\_\_\_\_\_  
Date

\_\_\_\_\_  
[Title of Officer/Representative]



## Utility Installation Request

<b>PERMIT NUMBER</b>		
<b>GLOBAL POSITIONING SYSTEM COORDINATES</b> (GPS) NORTH AMERICAN DATUM 1983, (1993 ADJUSTMENT) IN DECIMAL DEGREES(DD)		
	LATITUDE (DD)	LONGITUDE (DD)
<b>BEGIN</b>		
<b>END</b>		

To the Texas Transportation Commission  
 c/o District Engineer, Texas Department of Transportation  
 \_\_\_\_\_, Texas

Date: \_\_\_\_\_

Formal notice is hereby given that \_\_\_\_\_  
 proposes to place a \_\_\_\_\_  
 line within the right of way of \_\_\_\_\_, RM \_\_\_\_\_, Displ. \_\_\_\_\_, to RM \_\_\_\_\_, Displ. \_\_\_\_\_, in \_\_\_\_\_  
 County Texas, MNT Sec. No. \_\_\_\_\_ as follows: (give location, length, general design, etc. Use  
 additional sheet as needed)

We will construct and maintain the line on the highway right of way as shown on the attached drawing and in accordance with the rules, regulations and policies of the Texas Department of Transportation (TxDOT), and all governing laws, including, but not limited to, the "Texas Engineering Practice Act," "Federal Clean Water Act," the "National Endangered Species Act," "Americans with Disabilities Act," and the "Federal Historic Preservation Act." Upon request by TxDOT at any time, we will submit to TxDOT proof of compliance with all governing laws, rules and regulations before commencement of construction. Plans shall include the design, proposed location, vertical elevations, and horizontal alignments of the facility based on the department's survey datum, the relationship to existing highway facilities and the right of way line, traffic safety and access procedures, and location of existing utilities that may be affected by the proposed utility facility. The location and description of the proposed line and appurtenances is more fully shown by a complete set of drawings attached to this Utility Installation Request (Request). We will give plans to TxDOT for each future proposed modification or expansion to our facility and TxDOT will have 30 days to review and approve the plans prior to commencement of the work. A new Request may be required as a condition of approval. Our organization will use Best Management Practices to minimize erosion and sedimentation resulting from the proposed installation, and we will revegetate the project area as indicated under "Revegetation Special Provisions." We will also ensure that traffic control measures complying with applicable portions of the Texas Manual of Uniform Traffic Control Devices will be installed and maintained for the duration of this installation.

When installing, modifying or maintaining our utility on controlled access facilities, we shall conform to the Texas Transportation Code, Title 6 Roadways, Chapter 203, Subchapter C, Control of Access, §203.031 (<http://www.statutes.legis.state.tx.us/>). We shall limit access for servicing this installation to access via (a) frontage roads where provided, (b) nearby or adjacent public roads or streets, (c) trails along or near the highway right of way lines, connecting only to an intersecting road; from any one or all of which entry may be made to the outer portion of the highway right of way for normal service and maintenance operations. Our rights of access to the through traffic roadways and ramps shall be subject to the same rules and regulations that apply to the general public.

It is expressly understood that TxDOT does not purport hereby to grant any right, claim, title or easement in or upon highway right of way. TxDOT may require us to relocate this line, subject to the provisions of governing laws, by giving us at least 30 days written notice. We understand a new Request will be required for the relocation. We will notify TxDOT prior to commencement of any operation which requires pruning of trees so that TxDOT may provide specifications to govern performance of work, including trimming, topping, tree balance, type of cuts, painting cuts and



clean up. We understand that these specifications are intended to preserve TxDOT's considerable investment in highway beautification plantings and by reducing damage due to trimming and to protect known endangered species.

Our installation shall not damage any part of the roadway structure or associated appurtenances. We will make adequate provisions to cause minimum inconveniences to the traveling public and adjacent property owners. We will not open-cut driveways or intersecting roadways without specific written permission from the owner.

Following approval, we will begin construction on or after

\_\_\_\_\_ Month / Day / Year

We understand TxDOT may place additional provisions and requirements as listed below, based upon, but not limited to, the type of utility being installed, local site conditions, soil types and traffic.

<b>Additional Provisions and Requirements (for TxDOT input only)</b>
<b>• General Special Provisions:</b>
<input checked="" type="checkbox"/> Are attached.
<input type="checkbox"/> Are not attached.
<b>• As-built Plans/Certifications of Construction:</b>
<input type="checkbox"/> Are required and shall be certified as accurate by an authorized representative of the company.
<input type="checkbox"/> Are required and shall be signed and sealed by a State of Texas Licensed Professional Engineer.
<input type="checkbox"/> Are not required
<input type="checkbox"/> Certification that utility was installed as approved
<b>• Re-vegetation Special Provisions:</b> In order to minimize erosion and sedimentation resulting from the proposed installation, the project area will be re-vegetated:
<input type="checkbox"/> In accordance with TxDOT's Standard Specification Item 164 which specifies the appropriate grass seed mix to be used; <b>or</b>
<input type="checkbox"/> As indicated on the attachment.
TxDOT Representative to be notified 48 hours prior to beginning construction:

If approved, we understand we will assume all risks associated with this installation within the TxDOT right of way. These risks include injuries to our workers, damage to contiguous utility lines that may be in the area and injuries or damage resulting from our failure to properly install and maintain the line.

If the character, use or function of our installation is materially changed from that approved under this Request, we will notify TxDOT within 30 days after the change. In the event of a voluntary or involuntary loss of public utility status, or other legal authority for longitudinal placement of the utility facility in the highway, or there is an abandonment of the facility without the approval of TxDOT, we will, at our expense, remove the unauthorized portion of the facility from the right of way.

If installation of the line is not begun prior to the 91st calendar day from date of issuance, we acknowledge that, unless otherwise extended, TxDOT's approval of this Request will automatically **expire**, and we will be required to resubmit our Request. All Request submissions, whether due to expiration of approval under this paragraph or new Requests for modifications and relocations shall be in accordance with the governing laws, rules, regulations and policies existing at the time of submission. In the event we fail to comply with any or all of the requirements as set forth in this Request, the State may take such action as it deems appropriate to compel our compliance.

By signing as/for the requestor below, I certify that I am authorized to represent the requestor, that I agree to the provisions and requirements included in this Utility Installation Request, and our commencement of construction will further attest to our review and acceptance of said additional provisions and requirements.



REQUESTOR	APPROVED BY TXDOT
Date:	Date:
By:	By: <b>Donald C. Toner, Jr., SR/WA</b>
Signature:	Signature:
Title:	Title: <b>Director, SPD Right of Way</b>
Address:	Address: <b>TxDOT – SPD ROW Office</b>
	<b>125 E 11<sup>th</sup> Street</b>
	<b>Austin, TX 78701-2483</b>
City State Zip Code	City State Zip Code
( )	<b>( 512 ) 531 - 5904</b>
Area Code Telephone Number	Area Code Telephone Number

### GENERAL SPECIAL PROVISION

- Requestor agrees to perform all project coordination, scheduling, notifications, permit requirements and submittals through TxDOT's designated design-build contractor or Developer listed below:

*[Insert contractors contact information]*



## CDA UTILITY ADJUSTMENT CHECKLIST

(To be included with Utility Assembly Submittal)

U-No.: \_\_\_\_\_

District: \_\_\_\_\_

Utility Owner: \_\_\_\_\_

County(ies): \_\_\_\_\_

CSJ No(s): R-\_\_\_\_\_ C-\_\_\_\_\_

Project Limits: \_\_\_\_\_ to \_\_\_\_\_

Federal ROW Project No.: \_\_\_\_\_

Reimbursement (*check one (1) box*): Actual Cost  Lump Sum  Non-Reimbursable

Alternate Procedure Approval Date: \_\_\_\_\_

Description of Work (*Approximate from/to stationing and line type*):

Estimated Start Date:	_____, 20____
Estimated Completion or Duration:	_____, 20____
Estimated Total Adjustment Costs:	\$ <u>0.00</u>
Estimated Betterment ( <i>in dollars and calculated %</i> ):	\$ <u>0.00</u> <u>0%</u>
Estimated Accrued Depreciation:	\$ <u>0.00</u>
Estimated Salvage:	\$ <u>0.00</u>
Credits and Vouchers:	\$ <u>0.00</u>
Eligibility Ratio ( <i>calculated and supported %</i> )	\$ <u>0.00</u> <u>0%</u>
Noteworthy Issues/Items:	_____





**ASSEMBLY PACKAGE**

1. Have the required number of Utility Adjustment Assemblies of which the TxDOT Copy is color coded, been submitted?

Yes  No  N/A

2. Have the following forms been submitted?

PUAA/UAAA:	Yes <input type="checkbox"/>	No <input type="checkbox"/>	N/A <input type="checkbox"/>
UJUA:	Yes <input type="checkbox"/>	No <input type="checkbox"/>	N/A <input type="checkbox"/>
Statement - Contract Work:	Yes <input type="checkbox"/>	No <input type="checkbox"/>	N/A <input type="checkbox"/>
U-1 Affidavit:	Yes <input type="checkbox"/>	No <input type="checkbox"/>	N/A <input type="checkbox"/>
Quitclaim Deed:	Yes <input type="checkbox"/>	No <input type="checkbox"/>	N/A <input type="checkbox"/>
UM/UDC Sign Off:	Yes <input type="checkbox"/>	No <input type="checkbox"/>	N/A <input type="checkbox"/>

3. Are all forms submitted complete and correct for the situation/circumstance of the Utility Adjustment?

Yes  No  N/A

**TRANSMITTAL MEMO**

4. If the Adjustment has unique characteristics, does the transmittal include explanations and clarifications?

Yes  No  N/A

5. Has a recommendation for approval been stated?

Yes  No  N/A

6. If the Utility Adjustment is in more than one (1) RCSJ (Local Jurisdictional Boundary), have the percentages in each jurisdiction been detailed?

Yes  No  N/A



### UTILITY ADJUSTMENT AGREEMENT

7. Have language modifications to the utility agreement been approved by TxDOT?  
Yes  No  N/A
8. Has the Utility consultant-engineering contract been reviewed and approved by the Developer's Utility Manager (UM)?  
Yes  No  N/A

### UTILITY ADJUSTMENT PLANS AND SPECIFICATIONS

9. Plans folded so as to fit into 8.5" x 11" file?  
Yes  No  N/A
10. Have the Utility Adjustments been designed for the Proposed Configuration?  
Yes  No  N/A
11. Project or vicinity plan provided?  
Yes  No  N/A
12. Have the plans for the Utility Adjustment been sealed by a Registered Professional Engineer (PE)?  
Yes  No  N/A
13. Has the Utility Owner signed the cover sheet of the plans verifying review and approval, if Developer is responsible for Engineering on either Owner Managed or Developer Managed Agreement?  
Yes  No  N/A
14. Backfill requirements met (item 400 referenced)?  
Yes  No  N/A
15. If excavation is required, do the plans included a note on OSHA trench excavation protection?  
Yes  No  N/A
16. Is a note provided in the plans that the adjustment will conform with the TMUTCD?



17.                    Yes                     No                     N/A   
If the adjustment involves a plastic water, sanitary sewer, or gas line, has a metal detection wire been included in the estimate or with detailed in the plans?

Yes                     No                     N/A

18.                    Has Barlow's Formula information been submitted for un-encased high pressure pipelines? (The Barlow's calculation must be provided by the utility owner. The following information is required to complete Barlow's formula.  $S = \text{Yield Strength}$ ,  $t = \text{Wall thickness}$ ,  $D = \text{Outside Diameter}$ ,  $F = \text{Design Factor}$ . Maximum Operating Pressure must also be given and compared to the pressure calculated with Barlow's. The Barlow calculation must be shown with the submission.)

Yes                     No                     N/A

19.                    If the pipeline is un-encased, is there adequate coating, wrapping and cathodic protection?

Yes                     No                     N/A

20.                    Information on plans sufficient and adequate to:

Determine necessity and justification of proposed work?

Yes                     No                     N/A

Demonstrate Utility Accommodation Rules compliance?

Yes                     No                     N/A

Indicate highway stationing, existing and proposed ROW, offsets from proposed ROW, existing and proposed grades, and edge of pavement lines?

Yes                     No                     N/A

Provide any other necessary or essential information such as pressure, flow, offset, type, condition, wall thickness, specifications etc.?

Yes                     No                     N/A

21.                    Is this Utility Adjustment within ROW project limits or directly related to work required within project limits?

Yes                     No                     N/A

22.                    Are any of the proposed utility facilities installed longitudinally within a control of access?

Yes                     No                     N/A



### COST ESTIMATE

23. Has the Developer's Utility Design Coordinator located on the plans the major items of material listed on the estimate by scaling or stationing?

Yes  No  N/A

24. If the agreed sum method has been marked, has a detailed, itemized estimate and matching plans been provided?

Yes  No  N/A

25. Is the estimate properly and adequately itemized and detailed?

Yes  No  N/A

26. Are overheads and loadings checked for reasonableness?

Yes  No  N/A

27. Replacement utility ROW charges justified and supported?

Yes  No  N/A

28. Eligibility ratio calculated and recommended?

Yes  No  N/A

29. Betterment credit applicable?

Yes  No  N/A

If yes, is credit calculated and applied properly?

Yes  No  N/A

30. Accrued Depreciation credit applicable?

Yes  No  N/A

If yes, is credit calculated and applied properly?



31.            Yes                       No                       N/A   
Salvage credit applicable?

Yes                       No                       N/A

If yes, is credit applied properly?

Yes                       No                       N/A

32.    Estimate extensions checked?

Yes                       No                       N/A

**AFFIDAVIT OF PROPERTY INTEREST**

33.    Proof of compensable property interest established by utility where applicable?

Yes                       No                       N/A

If yes, according to the “**Real Property Interest**” paragraph of the PUA:

Does the estimate detail reimbursement for “New Property” interest?

Yes                       No                       N/A

Does the estimate detail compensation for relinquishing “Existing Property” interest?

Yes                       No                       N/A

Did the utility owner provide a letter stating that they will quitclaim their property interest at no costs or an agreed sum if new utility property interests are not being acquired?

Yes                       No                       N/A

34.    Have the parcel ID numbers to be Quitclaimed been identified?

Yes                       No                       N/A

35.    Has the owner provided a signed letter of intent to Quitclaim, and has a copy of the correct Quitclaim Deed(s) been submitted?

Yes                       No                       N/A



**R.O.W. MAPS**

36. Approved and current ROW Maps on file with project office?

Yes

No

N/A

37. Have the existing and proposed utility facilities been plotted on the ROW map and attached to this assembly?

Yes

No

N/A

**COMMENTS:** \_\_\_\_\_

Prepared by: \_\_\_\_\_  
 Utility Design Coordinator

\_\_\_\_\_  
 Date

Recommended for  
 Approval by: \_\_\_\_\_  
 Quality Control

\_\_\_\_\_  
 Date

Approved by: \_\_\_\_\_  
 Utility Manager

\_\_\_\_\_  
 Date



County: \_\_\_\_\_  
 ROW CSJ No.: \_\_\_\_\_  
 Const. CSJ No.: \_\_\_\_\_  
 Highway: \_\_\_\_\_  
 Fed. Proj. No.: \_\_\_\_\_  
 Limits: \_\_\_\_\_ to \_\_\_\_\_

**PROJECT UTILITY ADJUSTMENT AGREEMENT  
 (DB Contractor-Managed)**

Agreement No.: \_\_\_\_\_ -U- \_\_\_\_\_

**THIS AGREEMENT**, by and between [DB Contractor], hereinafter identified as the “**DB Contractor**” and [Utility Owner], hereinafter identified as the “**Owner**”, is as follows:

**WITNESSETH**

**WHEREAS**, the STATE OF TEXAS, acting by and through the Texas Department of Transportation, hereinafter identified as “TxDOT”, is authorized to design, construct, operate, maintain, and improve projects as part of the state highway system throughout the State of Texas, all in conformance with the applicable provisions of Chapters 201, 203, 222, 223, 224 and 228 of the Texas Transportation Code, as amended; and

**WHEREAS**, TxDOT proposes to construct a project identified as [Project Name] (the “Project”) and classified as either Interstate, Toll or Traditional (meaning eligibility based on existing compensable interest in the land occupied by the facility to be relocated within the proposed highway right of way limits) as indicated below (*check one (1) box*). Reimbursement will be authorized by the type of project selected below in conformance with §203.092 of the Transportation Code,

- Interstate
- Toll
- Traditional

; and

**WHEREAS**, pursuant to that certain [Design-Build Agreement (“DBA”)] [Comprehensive Development Agreement (“CDA”)] by and between TxDOT and the DB Contractor with respect to the Project, the DB Contractor has undertaken the obligation to design, construct, finance, operate and maintain the Project and adhere to all requirements in the [DBA][CDA]; and

**WHEREAS**, the DB Contractor’s duties pursuant to the [DBA][CDA] include causing the relocation, removal or other necessary adjustment of existing Utilities impacted by the Project (collectively, “Adjustment”), subject to the provisions herein; and

**WHEREAS**, the Project may receive Federal funding, financing and/or credit assistance; and



**WHEREAS**, the DB Contractor has notified the Owner that certain of its facilities and appurtenances (the “Owner Utilities”) are in locational conflict with the Project (and/or with the Ultimate Configuration of the Project), and the Owner has requested that the DB Contractor undertake the Adjustment of the Owner Utilities as necessary to accommodate the Project (and the Ultimate Configuration) and the Owner agrees that the “Project” will be constructed in accordance with §203.092 of the Texas Transportation Code, as amended, and 23 CFR 645 Subpart A (Utility Relocations, Adjustments and Reimbursement); and

**WHEREAS**, the Owner Utilities and the proposed Adjustment of the Owner Utilities are described as follows *[insert below a description of the affected facilities (by type, size and location) as well as a brief description of the nature of the Adjustment work to be performed (e.g., “adjust 12” waterline from approximately Highway Station 100+00 to approximately Highway Station 200+00)]*:

\_\_\_\_; and

**WHEREAS**, the Owner recognizes that time is of the essence in completing the work contemplated herein; and

**WHEREAS**, the DB Contractor and the Owner desire to implement the Adjustment of the Owner Utilities by entering into this Agreement.

### AGREEMENT

**NOW, THEREFORE**, in consideration of these premises and of the mutual covenants and agreements of the parties hereto and other good and valuable consideration, the receipt and sufficiency of which being hereby acknowledged, the DB Contractor and the Owner agree as follows:

1. **Preparation of Plans.** *[Check one (1) box that applies:]*

The DB Contractor has hired engineering firm(s) acceptable to the Owner to perform all engineering services needed for the preparation of plans, required specifications, and cost estimates, attached hereto as Exhibit A (collectively, the “Plans”), for the proposed Adjustment of the Owner Utilities. The DB Contractor represents and warrants that the Plans conform to the most recent Utility Accommodation Rules issued by the Texas Department of Transportation (“TxDOT”), as set forth in 43 Texas Administrative Code Part 1, Chapter 21, Subchapter C, *et seq.* (the “UAR”). By its execution of this Agreement or by the signing of the Plans, the Owner hereby approves and confirms that the Plans are in compliance with the “standards” described in Paragraph 3(a)(4).

The Owner has provided plans, required specifications and cost estimates, attached hereto as Exhibit A (collectively, the “Plans”), for the proposed Adjustment of the Owner Utilities. The Owner represents and warrants that the Plans conform to the most recent Utility Accommodation Rules issued by the Texas Department of Transportation (“TxDOT”), as set forth in 43 Texas Administrative Code Part 1, Chapter 21, Subchapter C, *et seq.* (the “UAR”). By its execution of this Agreement, the DB Contractor and the Owner hereby approve the Plans. The Owner also has provided to the DB Contractor a Utility plan view map illustrating the location of existing and proposed Utility facilities on the DB Contractor’s right of way map of the Project. With regard to its preparation of the Plans, the Owner represents as follows *[check one (1) box that applies]*:





- The Owner's employees were utilized to prepare the Plans, and the charges therefore do not exceed the Owner's typical costs for such work.
- The Owner utilized consulting engineers to prepare the Plans, and the fees for such work are not based upon a percentage of construction costs. Further, such fees encompass only the work necessary to prepare the Plans for Adjustment of the Owner Utilities described herein, and do not include fees for work done on any other project. The fees of the consulting engineers are reasonable and are comparable to the fees typically charged by consulting engineers in the locale of the Project for comparable work for the Owner.

2. **Review by TxDOT.** The parties hereto acknowledge and agree as follows:

- (a) Upon execution of this Agreement by the DB Contractor and the Owner, the DB Contractor will submit this Agreement, together with the attached Plans, to TxDOT for its review and approval as part of a package referred to as a "Utility Assembly". The parties agree to cooperate in good faith to modify this Agreement and/or the Plans, as necessary and mutually acceptable to all parties, to respond to any comments made by TxDOT thereon. Without limiting the generality of the foregoing:
  - (1) The Owner agrees to respond (with comment and/or acceptance) to any modified Plans and/or Agreement prepared by the DB Contractor in response to TxDOT comments within **14 Business Days** after receipt of such modifications; and
  - (2) If the Owner originally prepared the Plans, the Owner agrees to modify the Plans in response to TxDOT comments and to submit such modified Plans to the DB Contractor for its comment and/or approval (and re-submittal to TxDOT for its comment and/or approval) within **14 Business Days** after receipt of TxDOT's comments.

The Owner's failure to timely respond to any modified Plans submitted by the DB Contractor pursuant to this paragraph shall be deemed the Owner's approval of same. If the Owner fails to timely prepare modified Plans which are its responsibility hereunder, then the DB Contractor shall have the right to modify the Plans for the Owner's approval as if the DB Contractor had originally prepared the Plans. The process set forth in this paragraph will be repeated until the Owner, the DB Contractor and TxDOT have all approved this Agreement and the Plans.

- (b) The parties hereto acknowledge and agree that TxDOT's review, comments and approval of a Utility Assembly or any component thereof shall constitute TxDOT's approval of the location and manner in which a Utility Assembly will be installed, adjusted, or relocated within the State Highway right of way (the "ROW"), subject to the DB Contractor and the Owner's satisfactory performance of the Adjustment work in accordance with the approved Plans. TxDOT has no duty to review Owner Utilities or components for their quality or adequacy to provide the intended Utility service.



3. **Design and Construction Standards.**

- (a) All design and construction performed for the Adjustment work which is the subject of this Agreement shall comply with and conform to the following:
- (1) All applicable local and State Laws, regulations, decrees, ordinances and policies, including the UAR, the *Utility Manual* issued by TxDOT (to the extent its requirements are mandatory for the Utility Adjustment necessitated by the Project, as communicated to the Owner by the DB Contractor or TxDOT), the requirements of the [DBA][CDA], and the policies of TxDOT;
  - (2) All Federal Laws, regulations, decrees, ordinances and policies applicable to projects receiving Federal funding, financing and/or credit assistance, including without limitation, 23 CFR 645 Subpart A and B; and the Buy America provisions of 23 U.S.C. §313 and 23 CFR 635.410. The Utility Owner shall supply, upon request by the DB Contractor or TxDOT, proof of compliance with the aforementioned Laws, rules and regulations prior to the commencement of construction;
  - (3) The terms of all governmental permits or other approvals, as well as any private approvals of third parties necessary for such work;
  - (4) The standard specifications, standards of practice, and construction methods (collectively, "standards") which the Owner customarily applies to Utility facilities comparable to the Owner Utilities that are constructed by the Owner or for the Owner by its contractors at the Owner's expense, which standards are current at the time this Agreement is signed by the Owner, and which the Owner has submitted to the DB Contractor in writing; and
  - (5) Owner agrees that all service matters must be placed outside of the State ROW.
- (b) Such design and construction also shall be consistent and compatible with:
- (1) The DB Contractor's current design and construction of the Project;
  - (2) The Ultimate Configuration for the Project; and
  - (3) Any other Utilities being installed in the same vicinity.

The Owner acknowledges receipt of Project plans and Ultimate Configuration documents from the DB Contractor as necessary to comply with the foregoing. In case of any inconsistency among any of the standards referenced in this Agreement, the most stringent standard shall apply.

- (c) The plans, specifications, and cost estimates contained in Exhibit A shall identify and detail all Utility facilities that the Owner intends to abandon in place rather than remove, including material type, quantity, size, age and condition. No facilities containing hazardous or contaminated materials may be abandoned, but shall be specifically



identified and removed in accordance with the requirements of subparagraph (a). It is understood and agreed that the DB Contractor shall not pay for the assessment and remediation or other corrective action relating to soil and ground water contamination caused by the Utility facility prior to the removal.

4. **Responsibility for Costs of Adjustment Work.** With the exception of any Betterment (hereinafter defined), the parties shall allocate the cost of any Adjustment between themselves as identified in Exhibit A and in accordance with §203.092 of the Texas Transportation Code. An allocation percentage may be determined by application of an eligibility ratio, if appropriate, as detailed in Exhibit A.

5. **Construction by the DB Contractor.**

- (a) The Owner hereby requests that the DB Contractor perform the construction necessary to adjust the Owner Utilities and the DB Contractor hereby agrees to perform such construction. All construction work hereunder shall be performed in a good and workmanlike manner, and in accordance with the Plans (except as modified pursuant to Paragraph 16).
- (b) The DB Contractor shall retain such contractor or contractors as are necessary to adjust the Owner Utilities.
- (c) The DB Contractor shall obtain all permits necessary for the construction to be performed by the DB Contractor hereunder, and the Owner shall cooperate in that process as needed.

6. **Reimbursement of Owner's Indirect Costs.**

- (a) DB Contractor agrees to reimburse the Owner its share, if applicable, of the Owner's indirect costs (e.g., engineering, inspection, testing, ROW) as identified in Exhibit A. When requested by the Owner, monthly progress payments will be made. The monthly payment will not exceed 90% of the estimated indirect work done to date. Once the indirect work is complete, final payment of the eligible indirect costs will be made. Intermediate payments shall not be construed as final payment for any items included in the intermediate payment.
- (b) The Owner's indirect costs associated with Adjustment of the Owner Utilities shall be developed pursuant to the method checked and described below [*check only one (1) box*]:

- (1) Actual related indirect costs accumulated in accordance with:
  - (i) A work order accounting procedure prescribed by the applicable Federal or State regulatory body, or
  - (ii) Established accounting procedure developed by the Owner and which the Owner uses in its regular operations

*(either (i) or (ii) referred to as "Actual Cost"), OR*



(2) The agreed sum of \$\_\_\_\_\_ (“**Agreed Sum**”) as supported by the analysis of the Owner’s estimated costs attached hereto as part of Exhibit A.

(c) All indirect costs charged to the DB Contractor by the Owner shall be reasonable and shall be computed using rates and schedules not exceeding those applicable to similar work performed by or for the Owner at the Owner’s expense. The DB Contractor’s performance of the Adjustment work hereunder and payment of the DB Contractor’s share of the Owner’s costs pursuant to this Agreement, if applicable, shall be full compensation to the Owner for all costs incurred by the Owner in adjusting the Owner Utilities (including without limitation, costs of relinquishing and/or acquiring right of way).

7. **Advancement of Funds by Owner for Construction Costs.**

(a) Advancement of Owner’s share, if any, of estimated costs, Exhibit A shall identify all estimated engineering and construction-related costs, including labor, material, equipment and other miscellaneous construction items. Exhibit A shall also identify the Owner’s and DB Contractor’s respective shares of the estimated costs. The Owner shall advance to the DB Contractor its allocated share, if any, of the estimated costs for construction and engineering work to be performed by the DB Contractor, in accordance with the following terms:

The Adjustment of the Owner’s Utilities does not require advancement of funds.

The Adjustment of the Owner’s Utilities does require advancement of funds and the terms agreed to between the DB Contractor and the Owner are listed below.

[Insert terms of advance funding to be agreed between DB Contractor and Owner]

\_\_\_\_\_

(b) Adjustment Based on Actual Costs or Agreed Sum

[Check the one (1) appropriate provision, if advancement of funds is required]:

The Owner is responsible for its share of the DB Contractor’s actual cost for the Adjustment, including the identified Betterment. Accordingly, upon completion of all Adjustment work to be performed by both parties pursuant to this Agreement, (i) the Owner shall pay to the DB Contractor the amount, if any, by which the actual cost of the Betterment (as determined in Paragraph 9(b)) *plus* the actual cost of Owner’s share of the Adjustment (based on the allocation set forth in Exhibit A) exceeds the estimated cost advanced by the Owner, or (ii) the DB Contractor shall refund to the Owner the amount, if any, by which such advance exceeds such actual cost, as applicable.

The Agreed Sum is the agreed and final amount due for the Adjustment, including any Betterment, under this Agreement. Accordingly, no adjustment (either up or down) of such amount shall be made based on actual costs.



8. **Invoices.** On invoices prepared by either the Owner or the DB Contractor, all costs developed using the “**Actual Cost**” method described in Paragraph 6(b)(1) shall be itemized in a format allowing for comparisons to the approved estimates, including listing each of the services performed, the amount of time spent and the date on which the service was performed. The original and three (3) copies of each invoice, together with (i) such supporting information to substantiate all invoices as reasonably requested, and (ii) such waivers and releases of liens as the other party may reasonably require, shall be submitted to the other party at the address for notices stated in Paragraph 21, unless otherwise directed pursuant to Paragraph 22.

The Owner and the DB Contractor shall make commercially reasonable efforts to submit final invoices no later than 120 days after completion of work. The Owner and the DB Contractor hereby acknowledge and agree that any costs submitted to the other party within 12 months following completion of all Adjustment work to be performed by the parties pursuant to this Agreement shall be deemed to have been abandoned and waived.

9. **Betterment and Salvage.**

- (a) For purposes of this Agreement, the term “Betterment” means any upgrading of an Owner Utility being adjusted that is not attributable to the construction of the Project and is made solely for the benefit of and at the election of the Owner, including but not limited to an increase in the capacity, capability, efficiency or function of the adjusted Utility over that provided by the existing Utility or an expansion of the existing Utility; *provided, however*, that the following are not considered Betterments:

- (1) Any upgrading which is required for accommodation of the Project;
- (2) Replacement devices or materials that are of equivalent standards although not identical;
- (3) Replacement of devices or materials no longer regularly manufactured with the next highest grade or size;
- (4) Any upgrading required by applicable Laws, regulations or ordinances;
- (5) Replacement devices or materials which are used for reasons of economy (e.g., non-stocked items that may be uneconomical to purchase); or
- (6) Any upgrading required by the Owner’s written “standards” meeting the requirements of Paragraph 3(a)(4) and deemed to be of direct benefit to the Project.

[*Include the following for fiber optic Owner Utilities only:*] Extension of an adjustment to the nearest splice boxes shall not be considered a Betterment if required by the Owner in order to maintain its written telephony standards.

- (b) It is understood and agreed that the DB Contractor shall not pay for any Betterments and that the Owner shall be solely responsible therefor. No Betterment may be performed hereunder which is incompatible with the Project or the Ultimate Configuration or which



cannot be performed within the other constraints of applicable Law, any applicable governmental approvals, including without limitation the scheduling requirements thereunder.

Accordingly, the parties agree as follows [*check the one (1) box that applies, and complete if appropriate*]:

- The Adjustment of the Owner Utilities pursuant to the Plans does not include any Betterment.
- The Adjustment of the Owner Utilities pursuant to the Plans includes a Betterment to the Owner Utilities by reason of [*Insert explanation, e.g. "replacing 12" pipe with 24" pipe*]: \_\_\_\_\_.

The DB Contractor has provided to the Owner comparative estimates for (i) all work to be performed by the DB Contractor pursuant to this Agreement, including work attributable to the Betterment, and (ii) the cost to perform such work without the Betterment, which estimates are hereby approved by the Owner. The estimated cost of the DB Contractor's work hereunder which is attributable to Betterment is \$\_\_\_\_\_, calculated by *subtracting* (ii) from (i). The percentage of the total cost of the DB Contractor's work hereunder which is attributable to Betterment is \_\_\_\_\_%, calculated by *subtracting* (ii) from (i), which remainder is *divided* by (i).

- (c) If Paragraph 9(b) identifies Betterment, the Owner shall advance to the DB Contractor, at least **14 Business Days** prior to the date scheduled for commencement of construction for Adjustment of the Owner Utilities, the estimated cost attributable to Betterment as set forth in Paragraph 9(b). Should the Owner fail to advance payment to the DB Contractor **14 Business Days** prior to commencement of the Adjustment construction, the DB Contractor shall have the option of commencing and completing (without delay) the Adjustment work without installation of the applicable Betterment. [*If Paragraph 9(b) identifies Betterment, check the one (1) appropriate provision*]:

- The estimated cost stated in Paragraph 9(b) is the agreed and final amount due for Betterment hereunder, and accordingly no adjustment (either up or down) of such amount shall be made based on actual costs.
- The Owner is responsible for the DB Contractor's actual cost for the identified Betterment. Accordingly, upon completion of all Adjustment work to be performed by both parties pursuant to this Agreement, (i) the Owner shall pay to the DB Contractor the amount, if any, by which the actual cost of the Betterment (determined as provided below in this paragraph) exceeds the estimated cost advanced by the Owner, or (ii) the DB Contractor shall refund to the Owner the amount, if any, by which such advance exceeds such actual cost, as applicable. Any additional payment by the Owner shall be due within **60 calendar days** after the Owner's receipt of the DB Contractor's invoice therefor, together with supporting documentation; any refund shall be due within **60 calendar days** after completion of the Adjustment work hereunder. The actual cost of Betterment incurred by the DB Contractor shall be calculated by *multiplying* (i) the



Betterment percentage stated in Paragraph 9(b), by (ii) the actual cost of all work performed by the DB Contractor pursuant to this Agreement (including work attributable to the Betterment), as invoiced by the DB Contractor to the Owner.

- (d) If Paragraph 9(b) identifies Betterment, the amount allocable to Betterment in the Owner's indirect costs shall be determined by applying the percentage of the Betterment calculated in Paragraph 9(b) to the Owner's indirect costs. The Owner's invoice to the DB Contractor for the DB Contractor's share of the Owner's indirect costs, shall credit the DB Contractor with any Betterment amount determined pursuant to this Paragraph 9(d).
  - (e) For any Adjustment from which the Owner recovers any materials and/or parts and retains or sells the same, after application of any applicable Betterment credit, the Owner's invoice to the DB Contractor for its costs shall credit the DB Contractor with the salvage value for such materials and/or parts.
  - (f) The determinations and calculations of Betterment described in this Paragraph 9 shall exclude right of way acquisition costs. Betterment in connection with right of way acquisition is addressed in Paragraph 15.
10. **Management of the Adjustment Work.** The DB Contractor will provide project management during the Adjustment of the Owner Utilities.
11. **Utility Investigations.** At the DB Contractor's request, the Owner shall assist the DB Contractor in locating any Utilities (including appurtenances) which are owned and/or operated by the Owner and may be impacted by the Project. Without limiting the generality of the foregoing, in order to help assure that neither the adjusted Owner Utilities nor existing, unadjusted Utilities owned or operated by the Utility Owner are damaged during construction of the Project, the Owner shall mark in the field the location of all such Utilities horizontally on the ground in advance of Project construction in the immediate area of such Utilities.
12. **Inspection and Acceptance by the Owner.**
- (a) Throughout the Adjustment construction hereunder, the Owner shall provide adequate inspectors for such construction. The work shall be inspected by the Owner's inspector(s) at least once each working day, and more often if such inspections are deemed necessary by Owner. Further, upon request by the DB Contractor or its Subcontractors, the Owner shall furnish an inspector at any reasonable time in which construction is underway pursuant to this Agreement, including occasions when construction is underway in excess of the usual 40 hour work week and at such other times as reasonably required. The Owner agrees to promptly notify the DB Contractor of any concerns resulting from any such inspection.
  - (b) The Owner shall perform a final inspection of the adjusted Owner Utilities, including conducting any tests as are necessary or appropriate, within **five (5) Business Days** after completion of construction hereunder. The Owner shall accept such construction if it is consistent with the performance standards described in Paragraph 3, by giving written notice of such acceptance to the DB Contractor within said **five (5) day** period. If the Owner does not accept the construction, then the Owner shall, not later than the



expiration of said **five (5) day** period, notify the DB Contractor in writing of its grounds for non-acceptance and suggestions for correcting the problem, and if the suggested corrections are justified, the DB Contractor will comply. The Owner shall re-inspect any revised construction (and retest if appropriate) and give notice of acceptance, no later than **five (5) Business Days** after completion of corrective work. The Owner's failure to inspect and to give any required notice of acceptance or non-acceptance within the specified time period shall be deemed accepted.

- (c) From and after the Owner's acceptance (or deemed acceptance) of an adjusted Owner Utility, the Owner agrees to accept ownership of, and full operation and maintenance responsibility for, such Owner Utility.
13. **Design Changes.** The DB Contractor will be responsible for additional Adjustment design and construction costs necessitated by design changes to the Project, upon the terms specified herein.
14. **Field Modifications.** The DB Contractor shall provide the Owner with documentation of any field modifications, including Utility Adjustment Field Modifications as well as minor changes described in Paragraph 16(b), occurring in the Adjustment of the Owner Utilities.
15. **Real Property Interests.**
- (a) The Owner has provided, or upon execution of this Agreement shall promptly provide to the DB Contractor, documentation acceptable to TxDOT indicating any right, title or interest in real property claimed by the Owner with respect to the Owner Utilities in their existing location(s). Such claims are subject to TxDOT's approval as part of its review of the DB Contractor Utility Assembly as described in Paragraph 2. Claims approved by TxDOT as to rights or interests are referred to herein as "**Existing Utility Property Interests**".
- (b) If acquisition of any new easement or other interest in real property ("**Replacement Utility Property Interest**") is necessary for the Adjustment of any Owner Utilities, then the Owner shall be responsible for undertaking such acquisition. The Owner shall implement each acquisition hereunder expeditiously so that related Adjustment construction can proceed in accordance with the DB Contractor's Project schedules. The DB Contractor shall be responsible for its share (as specified in Paragraph 4) of the actual and reasonable acquisition costs of any such Replacement Utility Property Interest (including without limitation the Owner's reasonable overhead charges and reasonable legal costs as well as compensation paid to the landowner), excluding any costs attributable to Betterment as described in Paragraph 15(c), and subject to the provisions of Paragraph 15(e); *provided, however*, that all acquisition costs shall be subject to the DB Contractor's prior written approval. Eligible acquisition costs shall be segregated from other costs on the Owner's estimates and invoices. Any such Replacement Utility Property Interest shall have a written valuation and shall be acquired in accordance with applicable Law.
- (c) The DB Contractor shall pay its share only for a replacement in kind of an Existing Utility Property Interest (e.g., in width and type), unless a Replacement Utility Property Interest exceeding such standard:





- (1) Is required in order to accommodate the Project or by compliance with applicable Law; or
- (2) Is called for by the DB Contractor in the interest of overall Project economy.

Any Replacement Utility Property Interest which is not the DB Contractor's responsibility pursuant to the preceding sentence shall be considered Betterment to the extent that it upgrades the Existing Utility Property Interest which it replaces, or in its entirety if the related Owner Utility was not installed pursuant to an Existing Utility Property Interest. Betterment costs shall be solely the Owner's responsibility.

- (d) For each Existing Utility Property Interest located within the Project right of way, upon completion of the related Adjustment work and its acceptance by the Owner, the Owner agrees to execute a quitclaim deed or other appropriate documentation relinquishing such Existing Utility Property Interest to TxDOT, unless the affected Owner Utility is remaining in its original location or is being reinstalled in a new location within the area subject to such Existing Utility Property Interest. If the Owner's facilities are remaining within the existing property interest, a Utility Joint Use Acknowledgement will be required. All quitclaim deeds or other relinquishment documents shall be subject to TxDOT's approval as part of its review of the Utility Assembly as described in Paragraph 2. For each such Existing Utility Property Interest relinquished by the Owner, the DB Contractor shall do one (1) of the following to compensate the Owner for such Existing Utility Property Interest, as appropriate:

- (1) If the Owner acquires a Replacement Utility Property Interest for the affected Owner Utility, the DB Contractor shall reimburse the Owner for the DB Contractor's share of the Owner's actual and reasonable acquisition costs in accordance with Paragraph 15(b), subject to Paragraph 15(c); or
- (2) If the Owner does not acquire a Replacement Utility Property Interest for the affected Owner Utility, the DB Contractor shall compensate the Owner for the DB Contractor's share of the market value of such relinquished Existing Utility Property Interest, as mutually agreed between the Owner and the DB Contractor and supported by a written valuation.

The compensation, if any, provided to the Owner pursuant to either subparagraph (i) or (ii) above shall constitute complete compensation to the Owner for the relinquished Existing Utility Property Interest and any Replacement Utility Property Interest, and not further compensation shall be due to the Owner from the DB Contractor or TxDOT on account of such Existing Utility Property Interest or Replacement Utility Property Interest.

- (e) All Utility Joint Use Acknowledgments (UJUA) or Utility Installation Requests, Form 1082 shall be subject to TxDOT approval as part of its review of the Utility Assembly as described in Paragraph 2. A Utility Joint Use Acknowledgment is required where an Existing Utility Property Interest exists and the existing or proposed Utility will remain or be adjusted within the boundaries of the Existing Utility Property Interest. All other accommodations not located on Existing Utility Property Interests will require a Utility Installation Request, Form 1082.



16. **Amendments and Modifications.** This Agreement may be amended or modified only by a written instrument executed by the parties hereto, in accordance with Paragraph 16(a) or Paragraph 16(b) below:
- (a) Except as otherwise provided in Paragraph 16(b), any amendment or modification to this Agreement or the Plans attached hereto shall be implemented by a Utility Adjustment Agreement Amendment (“UAAA”) in the form of Exhibit B hereto (SPD ROW-U-UAAA-DM). The UAAA form can be used for a new scope of work with concurrence of the DB Contractor and TxDOT as long as the design and construction responsibilities have not changed. Each UAAA is subject to the review and approval of TxDOT, prior to its becoming effective for any purpose and prior to any work being initiated thereunder. The Owner agrees to keep and track costs for each UAAA separately from other work being performed.
  - (b) For purposes of this Paragraph 16(b), “**Utility Adjustment Field Modification**” shall mean any horizontal or vertical design change from the Plans included in a Utility Assembly previously approved by TxDOT, due either to design of the Project or to conditions not accurately reflected in the approved Utility Assembly (e.g., shifting the alignment of an 8 inch water line to miss a modified or new roadway drainage structure). A Utility Adjustment Field Modification agreed upon by the DB Contractor and the Owner does not require a UAAA, provided that the modified Plans have been submitted to TxDOT for its review and comment. A minor change (e.g., an additional water valve, an added Utility marker at a ROW line, a change in vertical bend, etc.) will not be considered a Utility Adjustment Field Modification and will not require a UAAA, but shall be shown in the documentation required pursuant to Paragraph 14.
  - (c) This Agreement does not alter and shall not be construed in any way to alter the obligations, responsibilities, benefits, rights, remedies, and claims between the DB Contractor and TxDOT to design and construct the Project, including the Adjustment.
17. **Entire Agreement.** This Agreement embodies the entire agreement between the parties and there are no oral or written agreements between the parties or any representations made which are not expressly set forth herein.
18. **Assignment; Binding Effect; TxDOT as Third-Party Beneficiary.** Neither the Owner nor the DB Contractor may assign any of its rights or delegate any of its duties under this Agreement without the prior written consent of the other party and of TxDOT, which consent may not be unreasonably withheld or delayed; *provided, however*, that the DB Contractor may assign any of its rights and/or delegate any of its duties to TxDOT or to any other entity engaged by TxDOT to fulfill the DB Contractor’s obligations, at any time without the prior consent of the Owner.

This Agreement shall bind the Owner, the DB Contractor and their successors and permitted assigns, and nothing in this Agreement nor in any approval subsequently provided by any party hereto shall be construed as giving any benefits, rights, remedies, or claims to any other person, firm, corporation or other entity, including, without limitation, any contractor or other party retained for the Adjustment work or the public in general; *provided, however*, that the Owner and the DB Contractor agree that although TxDOT is not a party to this Agreement, TxDOT is intended to be a third-party beneficiary to this Agreement.





A party sending notice of default of this Agreement to another party shall also send a copy of such notice to TxDOT at the following address:

TxDOT: Texas Department of Transportation  
Attention: Strategic Projects Division – ROW Office  
125 E 11<sup>th</sup> Street  
Austin, TX 78701-2483

Any notice or demand required herein shall be given (a) personally, (b) by certified or registered mail, postage prepaid, return receipt requested, or (c) by reliable messenger or overnight courier to the appropriate address set forth above. Any notice served personally shall be deemed delivered upon receipt, and any notice served by certified or registered mail or by reliable messenger or overnight courier shall be deemed delivered on the date of receipt as shown on the addressee's registry or certification of receipt or on the date receipt is refused as shown on the records or manifest of the U.S. Postal Service or such courier. Any party may designate any other address for this purpose by written notice to all other parties; TxDOT may designate another address by written notice to all parties.

22. **Approvals.** Any acceptance, approval, or any other like action (collectively "**Approval**") required or permitted to be given by the DB Contractor, the Owner or TxDOT pursuant to this Agreement:

- (a) Must be in writing to be effective (except if deemed granted pursuant hereto);
- (b) Shall not be unreasonably withheld or delayed; and if Approval is withheld, such withholding shall be in writing and shall state with specificity the reason for withholding such Approval, and every effort shall be made to identify with as much detail as possible what changes are required for Approval; and
- (c) Except for approvals by TxDOT, and except as may be specifically provided otherwise in this Agreement, shall be deemed granted if no response is provided to the party requesting an Approval within the time period prescribed by this Agreement (or if no time period is prescribed, then **14 calendar days**), commencing upon actual receipt by the party from which an Approval is requested or required, of a request for Approval from the requesting party. All requests for Approval shall be sent out by the requesting party to the other party in accordance with Paragraph 21.

23. **Time.**

- (a) Time is of the essence in the performance of this Agreement.
- (b) All references to "days" herein shall be construed to refer to calendar days, unless otherwise stated.
- (c) No party shall be liable to another party for any delay in performance under this Agreement from any cause beyond its control and without its fault or negligence ("**Force Majeure**"), such as acts of God, acts of civil or military authority, fire, earthquake, strike, unusually severe weather, floods or power blackouts.



24. **Continuing Performance.** In the event of a dispute, the Owner and the DB Contractor agree to continue their respective performance hereunder to the extent feasible in light of the dispute, including paying billings, and such continuation of efforts and payment of billings shall not be construed as a waiver of any legal right.
25. **Equitable Relief.** The DB Contractor and the Owner acknowledge and agree that delays in Adjustment of the Owner Utilities will impact the public convenience, safety and welfare, and that (without limiting the parties' remedies hereunder) monetary damages would be inadequate to compensate for delays in the construction of the Project. Consequently, the parties hereto (and TxDOT as well, as a third-party beneficiary) shall be entitled to specific performance or other equitable relief in the event of any breach of this Agreement which threatens to delay construction of the Project; *provided, however*, that the fact that specific performance or other equitable relief may be granted shall not prejudice any claims for payment or otherwise related to performance of the Adjustment work hereunder.
26. **Authority.** The Owner and the DB Contractor each represent and warrant to the other party that the warranting party possesses the legal authority to enter into this Agreement and that it has taken all actions necessary to exercise that authority and to lawfully authorize its undersigned signatory to execute this Agreement and to bind such party to its terms. Each person executing this Agreement on behalf of a party warrants that he or she is duly authorized to enter into this Agreement on behalf of such party and to bind it to the terms hereof.
27. **Cooperation.** The parties acknowledge that the timely completion of the Project will be influenced by the ability of the Owner (and its contractors) and the DB Contractor to coordinate their activities, communicate with each other, and respond promptly to reasonable requests. Subject to the terms and conditions of this Agreement, the Owner and the DB Contractor agree to take all steps reasonably required to coordinate their respective duties hereunder in a manner consistent with the DB Contractor's current and future construction schedules for the Project.
28. **Termination.** If the Project is canceled or modified so as to eliminate the necessity of the Adjustment work described herein, then the DB Contractor shall notify the Owner in writing and the DB Contractor reserves the right to thereupon terminate this Agreement. Upon such termination, the parties shall negotiate in good faith an amendment that shall provide mutually acceptable terms and conditions for handling the respective rights and liabilities of the parties relating to such termination.
29. **Nondiscrimination.** Each party hereto agrees, with respect to the work performed by such party pursuant to this Agreement that such party shall not discriminate on the grounds of race, color, sex, national origin or disability in the selection and/or retention of contractors and consultants, including procurement of materials and leases of equipment.
30. **Applicable Law, Jurisdiction and Venue.** This Agreement shall be governed by the Laws of the State of Texas, without regard to the Conflict of Laws principles thereof. Venue for any action brought to enforce this Agreement or relating to the relationship between any of the parties shall be the District Court of \_\_\_\_\_ County, Texas [or the United States District Court for the Western District of Texas (Austin)].



31. **Relationship of the Parties.** This Agreement does not in any way, and shall not be construed to, create a principal/agent or joint venture relationship between the parties hereto and under no circumstances shall the Owner or the DB Contractor be considered as or represent itself to be an agent of the other.
32. **Waiver of Consequential Damages.** No party hereto shall be liable to any other party to this Agreement, whether in contract, tort, equity, or otherwise (including negligence, warranty, indemnity, strict liability, or otherwise) for any punitive, exemplary, special, indirect, incidental, or consequential damages, including, without limitation, loss of profits or revenues, loss of use, claims of customers, or loss of business opportunity.
33. **Captions.** The captions and headings of the various paragraphs of this Agreement are for convenience and identification only, and shall not be deemed to limit or define the content of their respective paragraphs.
34. **Counterparts.** This Agreement may be executed in any number of counterparts. Each such counterpart hereof shall be deemed to be an original instrument but all such counterparts together shall constitute one (1) and the same instrument.
35. **Effective Date.** This Agreement shall become effective upon the later of (a) the date of signing by the last party (either the Owner or DB Contractor) signing this Agreement, and (b) the date of TxDOT's approval as indicated by the signature of TxDOT's representative below.



APPROVED BY:

**TEXAS DEPARTMENT OF  
TRANSPORTATION**

By: Donald C. Toner, Jr., SR/WA  
[Printed Name]

By: \_\_\_\_\_  
Authorized Signature

Director of SPD Right of Way  
Strategic Projects Division

Date: \_\_\_\_\_

**OWNER**

By: \_\_\_\_\_  
[Print Owner Name]

By: \_\_\_\_\_  
Duly Authorized Representative

[Title]  
[Company]

Date: \_\_\_\_\_

**DB CONTRACTOR**

By: \_\_\_\_\_  
[Print Name]

By: \_\_\_\_\_  
Duly Authorized Representative

[Title]  
[Company]

Date: \_\_\_\_\_



County: \_\_\_\_\_  
 ROW CSJ No.: \_\_\_\_\_  
 Const. CSJ No.: \_\_\_\_\_  
 Highway: \_\_\_\_\_  
 Fed. Proj. No.: \_\_\_\_\_  
 Limits: \_\_\_\_\_ to \_\_\_\_\_

**PROJECT UTILITY ADJUSTMENT AGREEMENT  
 (Owner-Managed)**

Agreement No.: \_\_\_\_\_ -U- \_\_\_\_\_

**THIS AGREEMENT**, by and between [DB Contractor], hereinafter identified as the "**DB Contractor**" and [Utility Owner], hereinafter identified as the "**Owner**", is as follows:

**WITNESSETH**

**WHEREAS**, the STATE OF TEXAS, acting by and through the Texas Department of Transportation, hereinafter identified as "TxDOT", is authorized to design, construct, operate, maintain, and improve projects as part of the state highway system throughout the State of Texas, all in conformance with the applicable provisions of Chapters 201, 203, 222, 223, 224 and 228 of the Texas Transportation Code, as amended; and

**WHEREAS**, TxDOT proposes to construct a project identified as the [Project Name] (the "Project") and classified as either Interstate, Toll or Traditional (meaning eligibility based on existing compensable interest in the land occupied by the facility to be relocated within the proposed highway right of way limits) as indicated below (*check one (1) box*). Reimbursement will be authorized by the type of project selected below in conformance with Transportation Code 203.092,

- Interstate
- Toll
- Traditional

;and

**WHEREAS**, pursuant to that certain [Design-Build Agreement ("DBA")] [Comprehensive Development Agreement ("CDA")] by and between TxDOT and the DB Contractor with respect to the Project, the DB Contractor has undertaken the obligation to design, construct, finance, operate and maintain the Project and adhere to all requirements in the [DBA][CDA]; and

**WHEREAS**, the DB Contractor's duties pursuant to the [DBA][CDA] include causing the relocation, removal, or other necessary adjustment of existing Utilities impacted by the Project (collectively, "Adjustment"), subject to the provisions herein; and

**WHEREAS**, the Project may receive Federal funding, financing and/or credit assistance; and





**WHEREAS**, the DB Contractor has notified the Owner that certain of its facilities and appurtenances (the "Owner Utilities") are in locational conflict with the Project (and/or the Ultimate Configuration of the Project), and the Owner has decided to undertake the Adjustment of the Owner Utilities and agrees that the "Project" will be constructed in accordance with §203.092 of the Texas Transportation Code, as amended, and 23 CFR 645 Subpart A (Utility Relocations, Adjustments and Reimbursement); and

**WHEREAS**, the Owner Utilities and the proposed Adjustment of the Owner Utilities are described as follows [*insert below a description of the affected facilities (by type, size and location) as well as a brief description of the nature of the Adjustment work to be performed (e.g., "adjust 12" waterline from approximately Highway Station 100+00 to approximately Highway Station 200+00")*]:

\_\_\_\_\_; and

**WHEREAS**, the Owner recognizes that time is of the essence in completing the work contemplated herein; and

**WHEREAS**, the DB Contractor and the Owner desire to implement the Adjustment of the Owner Utilities by entering into this Agreement.

#### AGREEMENT

**NOW, THEREFORE**, in consideration of these premises and of the mutual covenants and agreements of the parties hereto and other good and valuable consideration, the receipt and sufficiency of which being hereby acknowledged, the DB Contractor and the Owner agree as follows:

1. **Preparation of Plans.** [*Check one (1) box that applies:*]

- The DB Contractor has hired engineering firm(s) acceptable to the Owner to perform all engineering services needed for the preparation of plans, required specifications, and cost estimates, attached hereto as Exhibit A (collectively, the "Plans"), for the proposed Adjustment of the Owner Utilities. The DB Contractor represents and warrants that the Plans conform to the most recent Utility Accommodation Rules issued by the Texas Department of Transportation ("TxDOT"), set forth in 43 Texas Administrative Code, Part 1, Chapter 21, Subchapter C, *et seq.* (the "UAR"). By its execution of this Agreement or by the signing of the Plans, the Owner hereby approves and confirms that the Plans are in compliance with the "standards" described in Paragraph 3(a)(4).
  
- The Owner has provided plans, required specifications and cost estimates, attached hereto as Exhibit A (collectively, the "Plans"), for the proposed Adjustment of the Owner Utilities. The Owner represents and warrants that the Plans conform to the Utility Accommodation Rules issued by the Texas Department of Transportation ("TxDOT"), as set forth in 43 Texas Administrative Code Part 1, Chapter 21, Subchapter C, *et seq.* (the "UAR"). By its execution of this Agreement, the DB Contractor and the Owner hereby approve the Plans. The Owner also has provided to the DB Contractor a Utility plan view map illustrating the location of existing and proposed Utility facilities on the DB Contractor's right of way map of the Project. With regard to its preparation of the Plans, the Owner represents as follows [*check one (1) box that applies*]:



- The Owner's employees were utilized to prepare the Plans, and the charges therefore do not exceed the Owner's typical costs for such work.
- The Owner utilized consulting engineers to prepare the Plans, and the fees for such work are not based upon a percentage of construction costs. Further, such fees encompass only the work necessary to prepare the Plans for Adjustment of the Owner Utilities described herein, and do not include fees for work done on any other project. The fees of the consulting engineers are reasonable and are comparable to the fees typically charged by consulting engineers in the locale of the Project for comparable work for the Owner.

2. **Review by TxDOT.** The parties hereto acknowledge and agree as follows:

- (a) Upon execution of this Agreement by the DB Contractor and the Owner, the DB Contractor will submit this Agreement, together with the attached Plans, to TxDOT for its review and approval as part of a package referred to as a "Utility Assembly". The parties agree to cooperate in good faith to modify this Agreement and/or the Plans, as necessary and mutually acceptable to all parties, to respond to any comments made by TxDOT thereon. Without limiting the generality of the foregoing:
  - (1) The Owner agrees to respond (with comment and/or acceptance) to any modified Plans and/or Agreement prepared by the DB Contractor in response to TxDOT comments within **14 business days** after receipt of such modifications; and
  - (2) If the Owner originally prepared the Plans, the Owner agrees to modify the Plans in response to TxDOT comments and to submit such modified Plans to the DB Contractor for its comment and/or approval (and resubmit to TxDOT for its comment and/or approval) within **14 business days** after receipt of TxDOT's comments.

The Owner's failure to timely respond to any modified Plans submitted by the DB Contractor pursuant to this paragraph shall be deemed the Owner's approval of same. If the Owner fails to timely prepare modified Plans which are its responsibility hereunder, then the DB Contractor shall have the right to modify the Plans for the Owner's approval as if the DB Contractor had originally prepared the Plans. The DB Contractor shall be responsible for providing Plans to and obtaining comments on and approval of the Plans from the DB Contractor. The process set forth in this paragraph will be repeated until the Owner, the DB Contractor and TxDOT have all approved this Agreement and the Plans.

- (b) The parties hereto acknowledge and agree that TxDOT's review, comments, and/or approval of a Utility Assembly or any component thereof shall constitute TxDOT's approval of the location and manner in which a Utility Assembly will be installed, adjusted, or relocated within the State Highway right of way (the "ROW"), subject to the DB Contractor and Owner's satisfactory performance of the Adjustment work in accordance with the approved Plans. TxDOT has no duty to review Owner facilities or components for their quality or adequacy to provide the intended Utility service.



3. **Design and Construction Standards.**

- (a) All design and construction performed for the Adjustment work which is the subject of this Agreement shall comply with and conform to the following:
- (1) All applicable local and State Laws, regulations, decrees, ordinances and policies, including the UAR, the Utility Manual issued by TxDOT (to the extent its requirements are mandatory for the Utility Adjustment necessitated by the Project, communicated to the Owner by the DB Contractor or TxDOT), the requirements of the [DBA][CDA], and the policies of TxDOT;
  - (2) All Federal Laws, regulations, decrees, ordinances and policies applicable to projects receiving Federal funding, financing and/or credit assistance, including without limitation 23 CFR 645 Subparts A and B and the Buy America provisions of 23 U.S.C § 313 and 23 CFR 635.410. The Utility Owner shall supply, upon request by the DB Contractor or TxDOT, proof of compliance with the aforementioned Laws, rules and regulations prior to the commencement of construction;
  - (3) The terms of all governmental permits or other approvals, as well as any private approvals of third parties necessary for such work;
  - (4) The standard specifications, standards of practice, and construction methods (collectively, "standards") which the Owner customarily applies to facilities comparable to the Owner Utilities that are constructed by the Owner or for the Owner by its contractors at the Owner's expense, which standards are current at the time this Agreement is signed by the Owner, and which the Owner has submitted to the DB Contractor in writing; and
  - (5) Owner agrees that all service meters must be placed outside of the State ROW.
- (b) Such design and construction also shall be consistent and compatible with:
- (1) The DB Contractor's current design and construction of the Project;
  - (2) The Ultimate Configuration for the Project; and
  - (3) Any other utilities being installed in the same vicinity.

The Owner acknowledges receipt from the DB Contractor of Project plans and Ultimate Configuration documents as necessary to comply with the foregoing. In case of any inconsistency among any of the standards referenced in this Agreement, the most stringent standard shall apply.

- (c) The plans, specifications, and cost estimates contained in Exhibit A shall identify and detail all Utility facilities that the Owner intends to abandon in place rather than remove, including material type, quantity, size, age, and condition. No facilities containing hazardous or contaminated materials may be abandoned, but shall be specifically identified and removed in accordance with the requirements of subparagraph (a). It is understood and agreed that the DB Contractor shall not pay for the assessment and



remediation or other corrective action relating to soil and ground water contamination caused by the utility facility prior to the removal.

4. **Construction by the Owner; Scheduling.**

- (a) The Owner hereby agrees to perform the construction necessary to adjust the Owner Utilities. All construction work hereunder shall be performed in a good and workmanlike manner, and in accordance with the Plans (except as modified pursuant to Paragraph 17). The Owner agrees that during the Adjustment of the Owner Utilities, the Owner and its contractors will coordinate their work with the DB Contractor so as not to interfere with the performance of work on the Project by the DB Contractor or by any other party. "Interfere" means any action or inaction that interrupts, interferes, delays or damages Project work.
- (b) The Owner may utilize its own employees or may retain such contractor or contractors as are necessary to adjust the Owner Utilities, through the procedures set forth in Form "Statement Covering Contract Work" attached hereto as Exhibit C. If the Owner utilizes its own employees for the Construction work portion of the Adjustment of Owner Utilities, this form is not required.
- (c) The Owner shall obtain all permits necessary for the construction to be performed by the Owner hereunder, and the DB Contractor shall cooperate in that process as needed. The Owner shall submit a traffic control plan to the DB Contractor as required for Adjustment work to be performed on existing road rights of way.
- (d) The Owner shall commence its construction for Adjustment of each Owner Utility hereunder promptly after (i) receiving written notice to proceed therewith from the DB Contractor, and (ii) any Project right of way necessary for such Adjustment has been acquired either by DB Contractor (for adjusted facilities to be located within the Project right of way) or by the Owner (for adjusted facilities to be located outside of the Project right of way), or a right-of-entry permitting Owner's construction has been obtained from the landowner by the DB Contractor or by the Owner with the DB Contractor's prior approval. The Owner shall notify the DB Contractor at least 72 hours prior to commencing construction for the Adjustment of each Owner Utility hereunder.
- (e) The Owner shall expeditiously stake the survey of the proposed locations of the Owner Utilities being adjusted, on the basis of the final approved Plans. The DB Contractor shall verify that the Owner's Utilities, whether moving to a new location or remaining in place, clear the planned construction of the Project as staked in the field as well as the Ultimate Configuration.
- (f) The Owner shall complete all of the Utility reconstruction and relocation work, including final testing and acceptance thereof [*check one (1) box that applies*]:
  - On or before **[Month] [Day], 20[15]**.
  - A duration not to exceed \_\_\_\_\_ calendar days upon notice to proceed by the DB Contractor.



- (g) The amount of reimbursement due to the Owner pursuant to this Agreement for the affected Adjustment(s) shall be reduced by 10% for each 30-day period (and by a pro rata amount of said 10% for any portion of a 30-day period) by which the final completion and acceptance date for the affected Adjustment(s) exceeds the applicable deadline. The provisions of this Paragraph 4(g) shall not limit any other remedy available to the DB Contractor at Law or in equity as a result of the Owner's failure to meet any deadline hereunder.

The above reduction applies except to the extent due to:

- (1) Force Majeure as described in Paragraph 24(c);
- (2) Any act or omission of the DB Contractor, if the Owner fails to meet any deadline established pursuant to Paragraph 4(f); or
- (3) If the DB Contractor and/or TxDOT determine, in their sole discretion, that a delay in the relocation work is the result of circumstances beyond the control of the Owner or Owner's contractor and the DB Contractor will not reduce the reimbursement.

5. **Costs of the Work.**

- (a) The Owner's costs for Adjustment of each Owner Utility shall be derived from:
- (1) The accumulated total of costs incurred by the Owner for design and construction of such Adjustment, *plus*
  - (2) The Owner's other related costs to the extent permitted pursuant to Paragraph 5(b) (including without limitation the eligible engineering costs incurred by the Owner for design prior to execution of this Agreement), *plus*
  - (3) The Owner's right of way acquisition costs, if any, which are reimbursable pursuant to Paragraph 16.
- (b) The Owner's costs associated with Adjustment of the Owner Utilities shall be developed pursuant to the method checked and described below [*check only one (1) box*]:
- (1) Actual costs accumulated in accordance with a work order accounting procedure prescribed by the applicable Federal or State regulatory body ("**Actual Cost**");
  - (2) Actual costs accumulated in accordance with an established accounting procedure developed by the Owner and which the Owner uses in its regular operations ("**Actual Cost**"); or
  - (3) The agreed sum of \$\_\_\_\_\_ ("**Agreed Sum**"), as supported by the analysis of estimated costs attached hereto as part of Exhibit A.



6. **Responsibility for Costs of Adjustment Work.** The Agreed Sum or Actual Cost, as applicable, of all work to be performed pursuant to this Agreement shall be allocated between the DB Contractor and the Owner as identified in Exhibit A and in accordance with § 203.092 of the Texas Transportation Code. An allocation percentage may be determined by application of an eligibility ratio, if appropriate, as detailed in Exhibit A; *provided, however*, that any portion of an Agreed Sum or Actual Cost attributable to Betterment shall be allocated 100% to the Owner in accordance with Paragraph 10. All costs charged to the DB Contractor by the Owner shall be reasonable and shall be computed using rates and schedules not exceeding those applicable to similar work performed by or for the Owner at the Owner's expense. Payment of the costs allocated to the DB Contractor pursuant to this Agreement (if any) shall be full compensation to the Owner for all costs incurred by the Owner in Adjusting the Owner Utilities (including without limitation costs of relinquishing and/or acquiring right of way).
  
7. **Billing, Payment, Records and Audits: Actual Cost Method.** The following provisions apply if the Owner's costs are developed under procedure (1) or (2) described in Paragraph 5(b):
  - (a) After (i) completion of all Adjustment work to be performed pursuant to this Agreement, (ii) the DB Contractor's final inspection of the Adjustment work by Owner hereunder (and resolution of any deficiencies found), and (iii) receipt of an invoice complying with the applicable requirements of Paragraph 9, the DB Contractor shall pay to the Owner an amount equal to 90% of the DB Contractor's share of the Owner's costs as shown in such final invoice (less amounts previously paid, and applicable credits). After completion of the DB Contractor's audit referenced in Paragraph 7(c) and the parties' mutual determination of any necessary adjustment to the final invoice resulting therefrom, the DB Contractor shall make any final payment due so that total payments will equal the total amount of the DB Contractor's share reflected on such final invoice (as adjusted, if applicable).
  - (b) When requested by the Owner and properly invoiced in accordance with Paragraph 9, the DB Contractor shall make intermediate payments to the Owner based upon the progress of the work completed at not more than monthly intervals, and such payments shall not exceed 90% of the DB Contractor's share of the Owner's eligible costs as shown in each such invoice (less applicable credits). Intermediate payments shall not be construed as final payment for any items included in the intermediate payment.
  - (c) The Owner shall maintain complete and accurate cost records for all work performed pursuant to this Agreement. The Owner shall maintain such records for four (4) years after receipt of final payment hereunder. The DB Contractor and their respective representatives shall be allowed to audit such records during the Owner's regular business hours. Unsupported charges will not be considered eligible for reimbursement. The parties shall mutually agree upon (and shall promptly implement by payment or refund, as applicable) any financial adjustment found necessary by the DB Contractor's audit. TxDOT, the Federal Highway Administration (FHWA), and their respective representatives also shall be allowed to audit such records upon reasonable notice to the Owner, during the Owner's regular business hours.



8. **Billing and Payment: Agreed Sum Method.** If the Owner's costs are developed under procedure (3) described in Paragraph 5(b), then the DB Contractor shall pay its share of the Agreed Sum to the Owner after completion of:
- (a) All Adjustment work to be performed pursuant to this Agreement;
  - (b) The DB Contractor's final inspection of the Adjustment work by Owner hereunder (and resolution of any deficiencies found); and
  - (c) The receipt of an invoice complying with the applicable requirements of Paragraph 9.
9. **Invoices.** If the Owner's costs are developed under procedure (1) or (2) described in Paragraph 5(b), then Owner shall list each of the services performed, the amount of time spent and the date on which the service was performed. The original and three (3) copies of each invoice shall be submitted to the DB Contractor at the address for notices stated in Paragraph 22, unless otherwise directed by the DB Contractor pursuant to Paragraph 23, together with:
- (a) Such supporting information to substantiate all invoices as reasonably requested by the DB Contractor; and
  - (b) Such waivers or releases of liens as the DB Contractor may reasonably require.

The Owner shall make commercially reasonable efforts to submit final invoices not later than 120 days after completion of work. Final invoices shall include any necessary quitclaim deeds pursuant to Paragraph 16, and all applicable record drawings accurately representing the Adjustment as installed. The Owner hereby acknowledges and agrees that any right it may have for reimbursement of any of its costs not submitted to the DB Contractor within 12 months following completion of all Adjustment work to be performed by both parties pursuant to this Agreement shall be deemed to have been abandoned and waived. Invoices shall clearly delineate total costs and those costs that are reimbursable pursuant to the terms of this Agreement.

10. **Betterment.**
- (a) For purposes of this Agreement, the term "Betterment" means any upgrading of an Owner Utility being adjusted that is not attributable to the construction of the Project and is made solely for the benefit of and at the election of the Owner, including but not limited to an increase in the capacity, capability, efficiency or function of the adjusted Utility over that provided by the existing Utility facility or an expansion of the existing Utility facility; provided, however, that the following are not considered Betterments:
    - (1) Any upgrading which is required for accommodation of the Project;
    - (2) Replacement devices or materials that are of equivalent standards although not identical;
    - (3) Replacement of devices or materials no longer regularly manufactured with the next highest grade or size;
    - (4) Any upgrading required by applicable Laws, regulations or ordinances;



- (5) Replacement devices or materials which are used for reasons of economy (e.g., non-stocked items may be uneconomical to purchase); or
- (6) Any upgrading required by the Owner's written "standards" meeting the requirements of Paragraph 3(a)(4) and deemed to be of direct benefit to the Project.

*[Include the following for fiber optic Owner Utilities only:]* Extension of an Adjustment to the nearest splice boxes shall not be considered a Betterment if required by the Owner in order to maintain its written telephony standards.

- (b) It is understood and agreed that the DB Contractor will not pay for any Betterments and that the Owner shall not be entitled to payment therefor. No Betterment may be performed in connection with the Adjustment of the Owner Utilities which is incompatible with the Project or the Ultimate Configuration or which cannot be performed within the other constraints of applicable Law and any applicable governmental approvals, including without limitation the scheduling requirements thereunder. Accordingly, the parties agree as follows *[check the one (1) box that applies and complete if appropriate]*:

The Adjustment of the Owner Utilities pursuant to the Plans does not include any Betterment.

The Adjustment of the Owner Utilities pursuant to the Plans includes Betterment to the Owner Utilities by reason of *[insert explanation, e.g. "replacing 12" pipe with 24" pipe]*: \_\_\_\_\_. The Owner has provided to the DB Contractor comparative estimates for (i) all costs for work to be performed by the Owner pursuant to this Agreement, including work attributable to the Betterment, and (ii) the cost to perform such work without the Betterment, which estimates are hereby approved by the DB Contractor. The estimated amount of the Owner's costs for work hereunder which is attributable to Betterment is \$\_\_\_\_\_, calculated by *subtracting* (ii) from (i). The percentage of the total cost of the Owner's work hereunder which is attributable to Betterment is \_\_\_\_\_%, calculated by *subtracting* (ii) from (i), which remainder shall be *divided* by (i).

- (c) If Paragraph 10(b) identifies Betterment, then the following shall apply:

- (1) If the Owner's costs are developed under procedure (3) described in Paragraph 5(b), then the Agreed Sum stated in that Paragraph includes any credits due to the DB Contractor on account of the identified Betterment, and no further adjustment shall be made on account of same.

- (2) If the Owner's costs are developed under procedure (1) or (2) described in Paragraph 5(b), the parties agree as follows *[If Paragraph 10(b) identifies Betterment and the Owner's costs are developed under procedure (1) or (2), check the one (1) appropriate provision]*:

The estimated cost stated in Paragraph 10(b) is the agreed and final amount due for Betterment hereunder. Accordingly, each intermediate invoice submitted pursuant to Paragraph 7(b) shall include a credit for an





appropriate percentage of the agreed Betterment amount, proportionate to the percentage of completion reflected in such invoice. The final invoice submitted pursuant to Paragraph 7(a) shall reflect the full amount of the agreed Betterment credit. For each invoice described in this paragraph, the credit for Betterment shall be applied before calculating the DB Contractor's share (pursuant to Paragraph 6) of the cost of the Adjustment work. No other adjustment (either up or down) shall be made based on actual Betterment costs.

- The Owner is responsible for the actual cost of the identified Betterment, determined by *multiplying* (a) the Betterment percentage stated in Paragraph 10(b), by (b) the actual cost of all work performed by the Owner pursuant to this Agreement (including work attributable to the Betterment), as invoiced by the Owner to the DB Contractor. Accordingly, each invoice submitted pursuant to either Paragraph 7(a) or Paragraph 7(b) shall credit the DB Contractor with an amount calculated by *multiplying* (x) the Betterment percentage stated in Paragraph 10(b), by (y) the amount billed on such invoice.

- (d) The determinations and calculations of Betterment described in this Paragraph 10 shall exclude right of way acquisition costs. Betterment in connection with right of way acquisition is addressed in Paragraph 16.

11. **Salvage.** For any Adjustment from which the Owner recovers any materials and/or parts and retains or sells the same, after application of any applicable Betterment credit, the DB Contractor is entitled to a credit for the salvage value of such materials and/or parts. If the Owner's costs are developed under procedure (1) or (2) described in Paragraph 5(b), then the final invoice submitted pursuant to Paragraph 7(a) shall credit the DB Contractor with the full salvage value. If the Owner's costs are developed under procedure (3) described in Paragraph 5(b), then the Agreed Sum includes any credit due to the DB Contractor on account of salvage.

12. **Utility Investigations.** At the DB Contractor's request, the Owner shall assist the DB Contractor in locating any Utilities (including appurtenances) which are owned and/or operated by Owner and may be impacted by the Project. Without limiting the generality of the foregoing, in order to help assure that neither the adjusted Owner Utilities nor existing, unadjusted Utilities owned or operated by the Owner are damaged during construction of the Project, the Owner shall mark in the field the location of all such Utilities horizontally on the ground in advance of Project construction in the immediate area of such Utilities.

13. **Inspection and Ownership of Owner Utilities.**

- (a) The DB Contractor shall have the right, at its own expense, to inspect the Adjustment work performed by the Owner or its contractors, during and upon completion of construction. All inspections of work shall be completed and any comment provided within **five (5) business days** after request for inspection is received.
- (b) The Owner shall accept full responsibility for all future repairs and maintenance of said Owner Utilities. In no event shall the DB Contractor or TxDOT become responsible for making any repairs or maintenance, or for discharging the cost of same. The provisions of this Paragraph 13(b) shall not limit any rights which the Owner may have against the DB



Contractor if either party respectively damages any Owner Utility as a result of its respective Project activities.

14. **Design Changes.** The DB Contractor will be responsible for additional Adjustment design and responsible for additional construction costs necessitated by design changes to the Project made after approval of the Plans, upon the terms specified herein.
15. **Field Modifications.** The Owner shall provide the DB Contractor with documentation of any field modifications, including Utility Adjustment Field Modifications as well as minor changes as described in Paragraph 17(b), occurring in the Adjustment of the Owner Utilities.
16. **Real Property Interests.**
  - (a) The Owner has provided, or upon execution of this Agreement shall promptly provide to the DB Contractor, documentation acceptable to TxDOT indicating any right, title or interest in real property claimed by the Owner with respect to the Owner Utilities in their existing location(s). Such claims are subject to TxDOT's approval as part of its review of the DB Contractor's Utility Assembly as described in Paragraph 2. Claims approved by TxDOT as to rights or interests are referred to herein as "**Existing Utility Property Interests**".
  - (b) If acquisition of any new easement or other interest in real property ("**Replacement Utility Property Interest**") is necessary for the Adjustment of any Owner Utilities, then the Owner shall be responsible for undertaking such acquisition. The Owner shall implement each acquisition hereunder expeditiously so that related Adjustment construction can proceed in accordance with the DB Contractor's Project schedules. The DB Contractor shall be responsible for its share (if any, as specified in Paragraph 6) of the actual and reasonable acquisition costs of any such Replacement Utility Property Interest (including without limitation the Owner's reasonable overhead charges and reasonable legal costs as well as compensation paid to the landowner), excluding any costs attributable to Betterment as described in Paragraph 16(c), and subject to the provisions of Paragraph 16(e); *provided, however*, that all acquisition costs shall be subject to the DB Contractor's prior written approval. Eligible acquisition costs shall be segregated from other costs on the Owner's estimates and invoices. Any such Replacement Utility Property Interest shall have a written valuation and shall be acquired in accordance with applicable Law.
  - (c) The DB Contractor shall pay its share only for a replacement in kind of an Existing Utility Property Interest (e.g., in width and type), unless a Replacement Utility Property Interest exceeding such standard:
    - (1) Is required in order to accommodate the Project or by compliance with applicable Law; or
    - (2) Is called for by the DB Contractor in the interest of overall Project economy.

Any Replacement Utility Property Interest which is not the DB Contractor's cost responsibility pursuant to the preceding sentence shall be considered a Betterment to the extent that it upgrades the Existing Utility Property Interest which it replaces, or in its



entirety if the related Owner Utility was not installed pursuant to an Existing Utility Property Interest. Betterment costs shall be solely the Owner's responsibility.

- (d) For each Existing Utility Property Interest located within the Project right of way, upon completion of the related Adjustment work and its acceptance by the Owner, the Owner agrees to execute a quitclaim deed or other appropriate documentation relinquishing such Existing Utility Property Interest to TxDOT, unless the affected Owner Utility is remaining in its original location or is being reinstalled in a new location within the area subject to such Existing Utility Property Interest. All quitclaim deeds or other relinquishment documents shall be subject to TxDOT's approval as part of its review of the Utility Assembly as described in Paragraph 2. For each Existing Utility Property Interest relinquished by the Owner, the DB Contractor shall do one (1) of the following to compensate the Owner for such Existing Utility Property Interest, as appropriate:
- (1) If the Owner acquires a Replacement Utility Property Interest for the affected Owner Utility, the DB Contractor shall reimburse the Owner for the DB Contractor's share of the Owner's actual and reasonable acquisition costs in accordance with Paragraph 16(b) and subject to Paragraph 16(c); or
  - (2) If the Owner does not acquire a Replacement Utility Property Interest for the affected Owner Utility, the DB Contractor shall compensate the Owner for the DB Contractor's share of the market value of such relinquished Existing Utility Property Interest, as mutually agreed between the Owner and the DB Contractor and supported by a written valuation.

The compensation, if any, provided to the Owner pursuant to either subparagraph (i) or subparagraph (ii) above shall constitute complete compensation to the Owner for the relinquished Existing Utility Property Interest and any Replacement Utility Property Interest, and no further compensation shall be due to the Owner from the DB Contractor or TxDOT on account of such Existing Utility Property Interest or Replacement Utility Property Interest.

- (e) All Utility Joint Use Acknowledgments (UJUA) or Utility Installation Requests (UIR), Form 1082 shall be subject to TxDOT approval as part of its review of the Utility Assembly as described in Paragraph 2. A Utility Joint Use Acknowledgment is required where an Existing Utility Property Interest exists and the existing or proposed Utility will remain or be adjusted within the boundaries of the Existing Utility Property Interest. All other accommodations not located on Existing Utility Property Interests will require a Utility Installation Request, Form 1082.

17. **Amendments and Modifications.** This Agreement may be amended or modified only by a written instrument executed by the parties hereto, in accordance with Paragraph 17(a) or Paragraph 17(b) below:

- (a) Except as otherwise provided in Paragraph 17(b), any amendment or modification to this Agreement or the Plans attached hereto shall be implemented by a Utility Adjustment Agreement Amendment ("UAAA") in the form of Exhibit B hereto (SPD ROW-U-UAAA-OM). The UAAA form can be used for a new scope of work with concurrence of the DB Contractor and TxDOT as long as the Design and Construction responsibilities have not changed. Each UAAA is subject to the review and approval of TxDOT, prior to



its becoming effective for any purpose and prior to any work being initiated thereunder. The Owner agrees to keep and track costs for each UAAA separately from other work being performed.

- (b) For purposes of this Paragraph 17(b), "**Utility Adjustment Field Modification**" shall mean any horizontal or vertical design change from the Plans included in a Utility Assembly previously approved by TxDOT, due either to design of the Project or to conditions not accurately reflected in the approved Utility Assembly (e.g., shifting the alignment of an 8 inch water line to miss a modified or new roadway drainage structure). A Utility Adjustment Field Modification agreed upon by the DB Contractor and the Owner does not require a UAAA, provided that the modified Plans have been submitted to TxDOT for its review and comment. A minor change (e.g., an additional water valve, an added Utility marker at a ROW line, a change in vertical bend, etc.) will not be considered a Utility Adjustment Field Modification and will not require a UAAA, but shall be shown in the documentation required pursuant to Paragraph 15.

18. **Entire Agreement.** This Agreement embodies the entire agreement between the parties and there are no oral or written agreements between the parties or any representations made which are not expressly set forth herein.
19. **Assignment; Binding Effect; TxDOT as Third Party Beneficiary.** The Owner and the DB Contractor may not assign any of its rights or delegate any of its duties under this Agreement without the prior written consent of the other parties and of TxDOT, which consent may not be unreasonably withheld or delayed; *provided, however*, that the DB Contractor may assign any of its rights and/or delegate any of its duties to TxDOT or to any other entity with which TxDOT contracts to fulfill the DB Contractor's obligations at any time without the prior consent of the Owner.

This Agreement shall bind the Owner, the DB Contractor and their successors and permitted assigns, and nothing in this Agreement nor in any approval subsequently provided by any party hereto shall be construed as giving any benefits, rights, remedies, or claims to any other person, firm, corporation or other entity, including, without limitation, any contractor or other party retained for the Adjustment work or the public in general; *provided, however*, that the Owner and the DB Contractor agree that although TxDOT is not a party to this Agreement, TxDOT is intended to be a third-party beneficiary to this Agreement.

20. **Breach by the Parties.**

- (a) If the Owner claims that the DB Contractor has breached any of its obligations under this Agreement, the Owner will notify the DB Contractor and TxDOT in writing of such breach, and the DB Contractor shall have **30 days** following receipt of such notice in which to cure such breach, before the Owner may invoke any remedies which may be available to it as a result of such breach; *provided, however*, that both during and after such period TxDOT shall have the right, but not the obligation, to cure any breach by the DB Contractor. Without limiting the generality of the foregoing:

- (1) TxDOT shall have no liability to the Owner for any act or omission committed by the DB Contractor in connection with this Agreement; and





23. **Approvals.** Any acceptance, approval, or any other like action (collectively "**Approval**") required or permitted to be given by either the DB Contractor or the Owner pursuant to this Agreement:
- (a) Must be in writing to be effective (except if deemed granted pursuant hereto);
  - (b) Shall not be unreasonably withheld or delayed; and if Approval is withheld, such withholding shall be in writing and shall state with specificity the reason for withholding such Approval, and every effort shall be made to identify with as much detail as possible what changes are required for Approval; and
  - (c) Except for approvals by TxDOT, and except as may be specifically provided otherwise in this Agreement, shall be deemed granted if no response is provided to the party requesting an Approval within the time period prescribed by this Agreement (or if no time period is prescribed, then **14 calendar days**), commencing upon actual receipt by the party from which an Approval is requested or required, of a request for Approval from the requesting party. All requests for Approval shall be sent out by the requesting party to the other party in accordance with Paragraph 22.
24. **Time; Force Majeure.**
- (a) Time is of the essence in the performance of this Agreement.
  - (b) All references to "days" herein shall be construed to refer to calendar days, unless otherwise stated.
  - (c) No party shall be liable to another party for any delay in performance under this Agreement from any cause beyond its control and without its fault or negligence ("**Force Majeure**"), such as acts of God, acts of civil or military authority, fire, earthquake, strike, unusually severe weather, floods or power blackouts. If any such event of Force Majeure occurs, the Owner agrees, if requested by the DB Contractor, to accelerate its efforts hereunder if reasonably feasible in order to regain lost time, so long as the DB Contractor agrees to reimburse the Owner for the reasonable and actual costs of such efforts.
25. **Continuing Performance.** In the event of a dispute, the Owner and the DB Contractor agree to continue their respective performance hereunder to the extent feasible in light of the dispute, including paying billings, and such continuation of efforts and payment of billings shall not be construed as a waiver of any legal right.
26. **Equitable Relief.** The DB Contractor and the Owner acknowledge and agree that delays in Adjustment of the Owner Utilities will impact the public convenience, safety and welfare, and that (without limiting the parties' remedies hereunder) monetary damages would be inadequate to compensate for delays in the construction of the Project. Consequently, the parties hereto (and TxDOT as well, as a third party beneficiary) shall be entitled to specific performance or other equitable relief in the event of any breach of this Agreement which threatens to delay construction of the Project; *provided, however*, that the fact that specific performance or other equitable relief may be granted shall not prejudice any claims for payment or otherwise related to performance of the Adjustment work hereunder.



27. **Authority.** The Owner and the DB Contractor each represent and warrant to the other party that the warranting party possesses the legal authority to enter into this Agreement and that it has taken all actions necessary to exercise that authority and to lawfully authorize its undersigned signatory to execute this Agreement and to bind such party to its terms. Each person executing this Agreement on behalf of a party warrants that he or she is duly authorized to enter into this Agreement on behalf of such party and to bind it to the terms hereof.
28. **Cooperation.** The parties acknowledge that the timely completion of the Project will be influenced by the ability of the Owner (and its contractors) and the DB Contractor to coordinate their activities, communicate with each other, and respond promptly to reasonable requests. Subject to the terms and conditions of this Agreement, the Owner and the DB Contractor agree to take all steps reasonably required to coordinate their respective duties hereunder in a manner consistent with the DB Contractor's current and future construction schedules for the Project. The Owner further agrees to require its contractors to coordinate their respective work hereunder with the DB Contractor.
29. **Termination.** If the Project is canceled or modified so as to eliminate the necessity of the Adjustment work described herein, then the DB Contractor shall notify the Owner in writing and the DB Contractor reserves the right to thereupon terminate this Agreement. Upon such termination, the parties shall negotiate in good faith an amendment that shall provide mutually acceptable terms and conditions for handling the respective rights and liabilities of the parties relating to such termination.
30. **Nondiscrimination.** Each party hereto agrees, with respect to the work performed by such party pursuant to this Agreement that such party shall not discriminate on the grounds of race, color, sex, national origin or disability in the selection and/or retention of contractors and consultants, including procurement of materials and leases of equipment.
31. **Applicable Law, Jurisdiction and Venue.** This Agreement shall be governed by the Laws of the State of Texas, without regard to the conflict of laws principles thereof. Venue for any action brought to enforce this Agreement or relating to the relationship between any of the parties shall be the District Court of \_\_\_\_\_ County, Texas [or the United States District Court for the Western District of Texas (Austin)].
32. **Relationship of the Parties.** This Agreement does not in any way, and shall not be construed to, create a principal/agent or joint venture relationship between the parties hereto and under no circumstances shall the Owner or the DB Contractor be considered as or represent itself to be an agent of the other.
33. **Waiver of Consequential Damages.** No party hereto shall be liable to any other party to this Agreement, whether in contract, tort, equity, or otherwise (including negligence, warranty, indemnity, strict liability, or otherwise), for any punitive, exemplary, special, indirect, incidental, or consequential damages, including, without limitation, loss of profits or revenues, loss of use, claims of customers, or loss of business opportunity.
34. **Captions.** The captions and headings of the various paragraphs of this Agreement are for convenience and identification only, and shall not be deemed to limit or define the content of their respective paragraphs.



35. **Counterparts.** This Agreement may be executed in any number of counterparts. Each such counterpart hereof shall be deemed to be an original instrument but all such counterparts together shall constitute one (1) and the same instrument.
  
36. **Effective Date.** This Agreement shall become effective upon the later of (a) the date of signing by the last party (either the Owner or the DB Contractor) signing this Agreement, and (b) the date of TxDOT's approval as indicated by the signature of TxDOT's representative below.





APPROVED BY:

**TEXAS DEPARTMENT OF  
TRANSPORTATION**

By: Donald C. Toner, Jr., SR/WA  
[Printed Name]

By: \_\_\_\_\_  
Authorized Signature

Director of SPD Right of Way  
Strategic Projects Division

Date: \_\_\_\_\_

**OWNER**

By: \_\_\_\_\_  
[Print Owner Name]

By: \_\_\_\_\_  
Duly Authorized Representative

[Title]  
[Company]

Date: \_\_\_\_\_

**DB CONTRACTOR**

By: \_\_\_\_\_  
[Print Name]

By: \_\_\_\_\_  
Duly Authorized Representative

[Title]  
[Company]

Date: \_\_\_\_\_



County: \_\_\_\_\_  
ROW CSJ No.: \_\_\_\_\_  
Const. CSJ No.: \_\_\_\_\_  
Highway: \_\_\_\_\_  
Fed. Proj. No.: \_\_\_\_\_  
Limits: \_\_\_\_\_ to \_\_\_\_\_

**UTILITY ADJUSTMENT AGREEMENT AMENDMENT  
(DB Contractor-Managed)**

**(Amendment No. \_\_\_\_\_ to Agreement No.: \_\_\_\_\_ -U-\_\_\_\_\_)**

**THIS AMENDMENT TO PROJECT UTILITY ADJUSTMENT AGREEMENT** (this “Amendment”), by and between, [DB Contractor] hereinafter identified as the “**DB Contractor**” and [Utility Owner], hereinafter identified as the “**Owner**”, is as follows:

**WITNESSETH**

**WHEREAS**, the STATE of TEXAS, acting by and through the Texas Department of Transportation, hereinafter identified as “**TxDOT**”, proposes to construct the project identified above (the “Project”, as more particularly described in the “Original Agreement”, defined below); and

**WHEREAS**, pursuant to that certain [Design-Build Agreement (“DBA”)] [Comprehensive Development Agreement (“CDA”)] by and between TxDOT and the DB Contractor with respect to the Project, the DB Contractor has undertaken the obligation to design, construct, and potentially maintain the Project, including causing the removal, relocation, or other necessary adjustment of existing Utilities impacted by the Project (collectively, “Adjustment”); and

**WHEREAS**, the Owner and DB Contractor are parties to that certain executed Project Utility Adjustment Agreement (PUAA) designated by the “Agreement No.” indicated above, as amended by previous amendments, if any (the “Original Agreement”), which provides for the Adjustment of certain Utilities owned and/or operated by the Owner (the “Owner Utilities”); and

**WHEREAS**, the parties are required to utilize this Amendment form in order to modify the Original Agreement to add the Adjustment of Owner Utilities facilities not covered by the Original Agreement; and

**WHEREAS**, the parties desire to amend the Original Agreement to add additional Owner Utility facility(ies), on the terms and conditions hereinafter set forth.



**NOW, THEREFORE,** in consideration of the agreements contained herein, the parties hereto agree as follows:

1. **Amendment.** The Original Agreement is hereby amended as follows:

1.1 **Plans.**

- (a) The description of the Owner Utilities and the proposed Adjustment of the Owner Utilities in the Original Agreement is hereby amended to add the following Utility facility(ies) (“**Additional Owner Utilities**”) and proposed Adjustment(s) to the Owner Utilities described in the Original Agreement [*insert below a description of the affected facilities (by type, size and location) as well as a brief description of the nature of the Adjustment work to be performed (e.g., “adjust 12” waterline from approximately Highway Station 100+00 to approximately Highway Station 200+00)*]: \_\_\_\_\_.
- (b) The Plans, as defined in Paragraph 1 of the Original Agreement, are hereby amended to add thereto the Plans, specifications and cost estimates attached hereto as Exhibit A; and
- (c) The Plans attached hereto as Exhibit A, along with this Amendment, shall be submitted upon execution to TxDOT in accordance with Paragraph 2 of the Original Agreement, and Paragraph 2 shall apply to this Amendment and the Plans attached hereto in the same manner as if this Amendment were the Original Agreement. If the Owner claims an Existing Utility Property Interest for any of the Additional Owner Utilities, documentation with respect to such claim shall be submitted to TxDOT as part of this Amendment and the attached Plans, in accordance with Paragraph 15(a) of the Original Agreement.

1.2 **Reimbursement of Owner’s Indirect Costs.** For purposes of Paragraph 6 of the Original Agreement, the following terms apply to the Additional Owner Utilities and proposed Adjustment:

- (a) DB Contractor agrees to reimburse the Owner its share of the Owner’s indirect costs (e.g., engineering, inspection, testing, ROW) as identified in Exhibit A. When requested by the Owner, monthly progress payments will be made. The monthly payment will not exceed 90% of the estimated indirect work done to date. Once the indirect work is complete, final payment of the eligible indirect costs will be made. Intermediate payments shall not be construed as final payment for any items included in the intermediate payment.
- (b) The Owner’s indirect costs associated with Adjustment of the Owner Utilities shall be developed pursuant to the method checked and described below [*check only one (1) box*]:
  - (1) Actual related indirect costs accumulated in accordance with:
    - (i) A work order accounting procedure prescribed by the applicable Federal or State regulatory body; or



- (ii) Established accounting procedure developed by the Owner and which the Owner uses in its regular operations;

*(either (i) or (ii) referred to as “Actual Cost”), or*

- (2) The agreed sum of \$\_\_\_\_\_ (“Agreed Sum”) as supported by the analysis of the Owner's estimated costs attached hereto as part of Exhibit A.

1.3 **Advancement of Funds by Owner for Construction Costs.**

- (a) Advancement of Owner’s share, if any, of estimated costs. Exhibit A shall identify all estimated engineering and construction-related costs, including labor, material, equipment and other miscellaneous construction items. Exhibit A shall also identify the Owner’s and DB Contractor’s respective shares of the estimated costs.

The Owner shall advance to the DB Contractor its allocated share, if any, of the estimated costs for construction and engineering work to be performed by DB Contractor, in accordance with the following terms:

- The Adjustment of the Owner’s Utilities does not require advancement of funds.
- The Adjustment of the Owner’s Utilities does require advancement of funds and the terms agreed to between the DB Contractor and Owner are listed below.

*[Insert terms of advance funding to be agreed between DB Contractor and Owner.]*

\_\_\_\_\_

- (b) Adjustment Based on Actual Costs or Agreed Sum.

*[Check the one (1) appropriate provision, if advancement of funds is required]:*

- The Owner is responsible for its share of the DB Contractor Actual Cost for the Adjustment, including the identified Betterment. Accordingly, upon completion of all Adjustment work to be performed by both parties pursuant to this Amendment:
  - (i) The Owner shall pay to the DB Contractor the amount, if any, by which the Actual Cost of the Betterment (as determined in Paragraph 9(b)) *plus* the Actual Cost of Owner’s share of the Adjustment (based on the allocation set forth in Exhibit A) exceeds the estimated cost advanced by the Owner; or



(ii) The DB Contractor shall refund to the Owner the amount, if any, by which such advance exceeds such Actual Cost, as applicable.

The Agreed Sum is the agreed and final amount due for the Adjustment, including any Betterment, under this Amendment. Accordingly, no adjustment (either up or down) of such amount shall be made based on Actual Costs.

1.4 **Responsibility for Costs of Adjustment Work.** For purposes of Paragraph 4 of the Original Agreement, responsibility for the Agreed Sum or Actual Cost, as applicable, of all Adjustment work to be performed pursuant to this Amendment shall be allocated between the DB Contractor and the Owner as identified in Exhibit A hereto and in accordance with §203.092 of the Texas Transportation Code. An allocation percentage may be determined by application of an eligibility ratio, if appropriate, as detailed in Exhibit A; *provided however*, that any portion of an Agreed Sum or Actual Cost attributable to Betterment shall be allocated 100% to the Owner in accordance with Paragraph 9 of the Original Agreement.

1.5 **Betterment.**

(a) Paragraph 9(b) (Betterment and Salvage) of the Original Agreement is hereby amended to add the following [*Check the one (1) box that applies, and complete if appropriate*]:

The Adjustment of the Additional Owner Utilities, pursuant to the Plans as amended herein, does not include any Betterment.

The Adjustment of the Additional Owner Utilities, pursuant to the Plans as amended herein, includes Betterment to the Additional Owner Utilities by reason of [*insert explanation, e.g. "replacing 12" pipe with 24" pipe*]: \_\_\_\_\_.

The DB Contractor has provided to the Owner comparative estimates for (i) all work to be performed by the DB Contractor pursuant to this Amendment, including work attributable to the Betterment, and (ii) the cost to perform such work without the Betterment, which estimates are hereby approved by the Owner. The estimated cost of the DB Contractor work under this Amendment which is attributable to Betterment is \$\_\_\_\_\_, calculated by *subtracting* (ii) from (i). The percentage of the total cost of the DB Contractor work under this Amendment which is attributable to Betterment is \_\_\_\_\_%, calculated by *subtracting* (ii) from (i), which remainder is *divided* by (i).

(b) If the above Paragraph 1.5(a) identifies Betterment, the Owner shall advance to the DB Contractor, at least **14 days** prior to the date scheduled for commencement of construction for Adjustment of the Additional Owner Utilities, the estimated cost attributable to Betterment as set forth in Paragraph 1.5(a) of this Amendment. If the Owner fails to advance payment to the DB Contractor on



or before the foregoing deadline, the DB Contractor shall have the option of commencing and completing (without delay) the Adjustment work without installation of the applicable Betterment. *[Check the one (1) appropriate provision]:*

- The estimated cost stated in Paragraph 1.5(a) of this Amendment is the agreed and final amount due for Betterment under this Amendment, and accordingly no adjustment (either up or down) of such amount shall be made based on actual costs.
  
  - The Owner is responsible for the DB Contractor Actual Cost for the identified Betterment. Accordingly, upon completion of all Adjustment work to be performed by both parties pursuant to this Amendment, (i) the Owner shall pay to the DB Contractor the amount, if any, by which the Actual Cost of the Betterment (determined as provided below in this paragraph) exceeds the estimated cost advanced by the Owner, or (ii) the DB Contractor shall refund to the Owner the amount, if any, by which such advance exceeds such Actual Cost, as applicable. Any additional payment by the Owner shall be due within **60 days** after the Owner's receipt of the DB Contractors invoice therefor, together with supporting documentation; any refund shall be due within **60 days** after completion of the Adjustment work under this Amendment. The Actual Cost of Betterment incurred by the DB Contractor shall be calculated by *multiplying* (i) the Betterment percentage stated in Paragraph 1.5(a) of this Amendment, by (ii) the Actual Cost of all work performed by the DB Contractor pursuant to this Amendment (including work attributable to the Betterment), as invoiced by the DB Contractor to the Owner.
- (c) The determinations and calculations of Betterment described in this Amendment shall exclude right of way acquisition costs. Betterment in connection with right of way acquisition is addressed in Paragraph 15 of the Original Agreement.

1.6 **Miscellaneous.**

- (a) The Owner and the DB Contractor agree to refer to this Amendment, designated by the "Amendment No." and "Agreement Number" indicated on page 1 above, on all future correspondence regarding the Adjustment work that is the subject of this Amendment and to track separately all costs relating to this Amendment and the Adjustment work described herein.
  
  - (b) *[Include any other proposed amendments allowed by applicable Law.]*
- \_\_\_\_\_

2. **General.**

- (a) All capitalized terms used in this Amendment shall have the meanings assigned to them in the Original Agreement, except as otherwise stated herein.



- (b) This Amendment may be executed in any number of counterparts. Each such counterpart hereof shall be deemed to be an original instrument but all such counterparts together shall constitute one (1) and the same instrument.
- (c) Except as amended hereby, the Original Agreement shall remain in full force and effect. In no event shall the responsibility, as between the Owner and the DB Contractor, for the preparation of the Plans and the Adjustment of the Owner Utilities be deemed to be amended hereby.
- (d) This Amendment shall become effective upon the later of (a) the date of signing by the last party (either the Owner or the DB Contractor) signing this Amendment, and (b) the completion of TxDOT's review and approval as indicated by the signature of TxDOT's representative below.

APPROVED BY:

**TEXAS DEPARTMENT OF  
TRANSPORTATION**

By: Donald C. Toner, Jr., SR/WA  
[Printed Name]

By: \_\_\_\_\_  
Authorized Signature

Director of SPD Right of Way  
Strategic Projects Division

Date: \_\_\_\_\_

**OWNER**

By: \_\_\_\_\_  
[Print Name]

By: \_\_\_\_\_  
Duly Authorized Representative Signature

[Title]  
[Company]

Date: \_\_\_\_\_

**DB CONTRACTOR**

By: \_\_\_\_\_  
[Print Name]

By: \_\_\_\_\_  
Duly Authorized Representative

[Title]  
[Company]

Date: \_\_\_\_\_



County: \_\_\_\_\_  
ROW CSJ No.: \_\_\_\_\_  
Const. CSJ No.: \_\_\_\_\_  
Highway: \_\_\_\_\_  
Fed. Proj. No.: \_\_\_\_\_  
Limits: \_\_\_\_\_ to \_\_\_\_\_

**UTILITY ADJUSTMENT AGREEMENT AMENDMENT  
(Owner-Managed)**

(Amendment No. \_\_\_\_\_ to Agreement No.: \_\_\_\_\_ - U - \_\_\_\_\_)

**THIS AMENDMENT TO PROJECT UTILITY ADJUSTMENT AGREEMENT** (this “Amendment”), by and between, [DB Contractor] hereinafter identified as the “**DB Contractor**” and [Utility Owner], hereinafter identified as the “**Owner**”, is as follows:

**WITNESSETH**

**WHEREAS**, the STATE of TEXAS, acting by and through the Texas Department of Transportation, hereinafter identified as “**TxDOT**”, proposes to construct the project identified above (the “Project”, as more particularly described in the “Original Agreement”, defined below); and

**WHEREAS**, pursuant to that certain [Design-Build Agreement (“DBA”)] [Comprehensive Development Agreement (“CDA”)] by and between TxDOT and the DB Contractor with respect to the Project, the DB Contractor has undertaken the obligation to design, construct, and potentially maintain the Project, including causing the removal, relocation, or other necessary adjustment of existing Utilities impacted by the Project (collectively, “Adjustment”); and

**WHEREAS**, the Owner and DB Contractor are parties to that certain executed Project Utility Adjustment Agreement (PUAA) designated by the “Agreement No.” indicated above, as amended by previous amendments, if any (the “Original Agreement”), which provides for the Adjustment of certain Utilities owned and/or operated by the Owner (the “Owner Utilities”); and

**WHEREAS**, the parties are required to utilize this Amendment form in order to modify the Original Agreement to add the Adjustment of Owner Utilities facilities not covered by the Original Agreement; and

**WHEREAS**, the parties desire to amend the Original Agreement to add additional Owner Utility facility(ies), on the terms and conditions hereinafter set forth.

**NOW, THEREFORE**, in consideration of the agreements contained herein, the parties hereto agree as follows:

1. **Amendment.** The Original Agreement is hereby amended as follows:

**Plans.**

- (a) The description of the Owner Utilities and the proposed Adjustment of the Owner Utilities in the Original Agreement is hereby amended to add the following Utility





facility(ies) (“**Additional Owner Utilities**”) and proposed Adjustment(s) *[insert below a description of the affected facilities (by type, size and location) as well as a brief description of the nature of the Adjustment work to be performed (e.g., “adjust 12” waterline from approximately Highway Station 100+00 to approximately Highway Station 200+00”)]*: \_\_\_\_\_.

- (b) The Plans, as defined in Paragraph 1 of the Original Agreement, are hereby amended to add thereto the Plans, specifications and cost estimates attached hereto as Exhibit A.
- (c) The Plans attached hereto as Exhibit A, along with this Amendment, shall be submitted upon execution to TxDOT in accordance with Paragraph 2 of the Original Agreement, and Paragraph 2 shall apply to this Amendment and the Plans attached hereto in the same manner as if this Amendment were the Original Agreement. If the Owner claims an Existing Utility Property Interest for any of the Additional Owner Utilities, documentation with respect to such claim shall be submitted to TxDOT as part of this Amendment and the attached Plans, in accordance with Paragraph 16(a) of the Original Agreement.
- (d) Paragraph 4(f) of the Original Agreement is hereby amended to add the following deadline for the Adjustment of the Additional Owner Utilities *[check one (1) box that applies]*:
  - Owner shall complete all of the Utility reconstruction and relocation work, including final testing and acceptance thereof, on or before **[Month] [Day], 2015**.
  - Owner shall complete all of the Utility reconstruction and relocation work, including final testing and acceptance thereof, within \_\_\_\_\_ **calendar days** after delivery to Owner of a notice to proceed by DB Contractor;
- (e) For purposes of Paragraph 5(b) of the Original Agreement, the Owner’s costs associated with Adjustment of the Additional Owner Utilities shall be developed pursuant to the method checked and described below *[check only one (1) box]*:
  - (1) Actual costs accumulated in accordance with a work order accounting procedure prescribed by the applicable Federal or State regulatory body (“**Actual Cost**”);
  - (2) Actual costs accumulated in accordance with an established accounting procedure developed by the Owner and which the Owner uses in its regular operations (“**Actual Cost**”); or
  - (3) The agreed sum of \$\_\_\_\_\_ (“**Agreed Sum**”), as supported by the analysis of estimated costs attached hereto as part of Exhibit A.
- (f) For purposes of Paragraph 6 of the Original Agreement, responsibility for the Agreed Sum or Actual Cost, as applicable, of all Adjustment work to be performed pursuant to this Amendment shall be allocated between the DB Contractor and the Owner as identified in Exhibit A and in accordance with §203.092 of the Texas Transportation



Code. An allocation percentage may be determined by application of an eligibility ratio, if appropriate, as detailed in Exhibit A; *provided, however*, that any portion of an Agreed Sum or Actual Cost attributable to Betterment shall be allocated 100% to the Owner in accordance with Paragraph 10 of the Original Agreement.

(g) Paragraph 10(b) of the Original Agreement is hereby amended to add the following [*Check the one (1) box that applies*]:

- The Adjustment of the Additional Owner Utilities, pursuant to the Plans as amended herein, does not include any Betterment.
- The Adjustment of the Additional Owner Utilities, pursuant to the Plans as amended herein, includes Betterment to the Additional Owner Utilities by reason of [*insert explanation, e.g. "replacing 12" pipe with 24" pipe*]: \_\_\_\_\_.

The Owner has provided to the DB Contractor comparative estimates for (i) all costs for work to be performed by the Owner pursuant to this Amendment, including work attributable to the Betterment, and (ii) the cost to perform such work without Betterment, which estimates are hereby approved by the DB Contractor. The estimated amount of the Owner's costs for work under this Agreement which is attributable to Betterment is \$\_\_\_\_\_, calculated by *subtracting* (ii) from (i). The percentage of the total cost of the Owner's work hereunder which is attributable to Betterment is \_\_\_\_\_%, calculated by *subtracting* (ii) from (i) which remainder shall be *divided* by (i).

(h) The following shall apply to any Betterment described in Paragraph 1(g) of this Amendment:

- (i) If the Owner's costs are developed under procedure (3) described in Paragraph 1(e) of this Amendment, then the Agreed Sum stated in that Paragraph includes any credits due to the DB Contractor on account of the identified Betterment, and no further adjustment shall be made on account of same.
- (ii) If the Owner's costs are developed under procedure (1) or (2) described in Paragraph 1(e) of this Amendment, the parties agree as follows [*check the one (1) appropriate provision*]:

- The estimated cost stated in Paragraph 1(g) of this Amendment is the agreed and final amount due for Betterment under this Amendment. Accordingly, each intermediate invoice submitted for Adjustment(s) of the Additional Owner Utilities pursuant to Paragraph 7(b) of the Original Agreement shall credit the DB Contractor with an appropriate amount of the agreed Betterment amount, proportionate to the percentage of completion reflected in such invoice. The final invoice submitted for Adjustment(s) of the Additional Owner Utilities pursuant to Paragraph 7(a) of the Original Agreement shall reflect the full amount of the agreed Betterment credit. For each invoice described in this paragraph, the credit for Betterment shall be applied before calculating the DB Contractor's share (pursuant to Paragraph 1(e) of this Amendment) of the cost of the



Adjustment work. No other adjustment (either up or down) shall be made based on actual Betterment costs.

The Owner is responsible for the Actual Cost of the identified Betterment, determined by *multiplying* (a) the Betterment percentage stated in Paragraph 1(g) of this Amendment, by (b) the actual cost of all work performed by the Owner pursuant to this Amendment (including work attributable to the Betterment), as invoiced by the Owner to the DB Contractor. Accordingly, each invoice submitted for Adjustment of the Additional Owner Utilities pursuant to either Paragraph 7(a) or Paragraph 7(b) of the Original Agreement shall credit the DB Contractor with an amount calculated by *multiplying* (x) the Betterment percentage stated in Paragraph 1(g) of this Amendment, by (y) the amount billed on such invoice.

- (i) The determinations and calculations of Betterment described in this Amendment shall exclude right of way acquisition costs. Betterment in connection with ROW acquisition is addressed in Paragraph 16 of the Original Agreement.
- (j) Owner and the DB Contractor agree to refer to this Amendment, designated by the "Amendment No." and "Agreement number" indicated on page 1 above, on all future correspondence regarding the Adjustment work that is the subject of this Amendment and to track separately all costs relating to this Amendment and the Adjustment work described herein.
- (k) *[Include any other proposed amendments in compliance with the applicable Law.]*

2. **General.**

- (a) All capitalized terms used in this Amendment shall have the meanings assigned to them in the Original Agreement, except as otherwise stated herein.
- (b) This Amendment may be executed in any number of counterparts. Each such counterpart hereof shall be deemed to be an original instrument but all such counterparts together shall constitute one (1) and the same instrument.
- (c) Except as amended hereby, the Original Agreement shall remain in full force and effect. In no event shall the responsibility, as between the Owner and the DB Contractor, for the preparation of the Plans and the Adjustment of the Owner Utilities be deemed to be amended hereby.
- (d) This Amendment shall become effective upon the later of (a) the date of signing by the last party (either the Owner or the DB Contractor) signing this Amendment, and (b) the completion of TxDOT's review and approval as indicated by the signature of TxDOT's representative below.



APPROVED BY:

**TEXAS DEPARTMENT OF  
 TRANSPORTATION**

By: Donald C. Toner, Jr., SR/WA  
 [Printed Name]

By: \_\_\_\_\_  
 Authorized Signature

Director of SPD Right of Way  
Strategic Projects Division

Date: \_\_\_\_\_

**OWNER**

By: \_\_\_\_\_  
 [Print Owner Name]

By: \_\_\_\_\_  
 Duly Authorized Representative

[Title]  
 [Company]

Date: \_\_\_\_\_

**DB CONTRACTOR**

By: \_\_\_\_\_  
 [Print Name]

By: \_\_\_\_\_  
 Duly Authorized Representative

[Title]  
 [Company]

Date: \_\_\_\_\_



## UTILITY JOINT USE ACKNOWLEDGMENT REIMBURSABLE UTILITY ADJUSTMENT

Agreement No.: \_\_\_\_\_

ROW CSJ: _____	County: _____
District: _____	Highway: _____
Fed. Proj. No.: _____	Limits: _____
Projected Letting Date: _____	From _____ to _____

**WHEREAS**, the State of Texas, (“**State**”), acting by and through the Texas Department of Transportation (“**TxDOT**”), proposes to make certain highway improvements on that section of the above-indicated highway; and

**WHEREAS**, the \_\_\_\_\_, (“**Utility**”), proposes to adjust or relocate certain of its facilities, if applicable, and retain title to any property rights it may have on, along or across, and within or over such limits of the highway right of way as indicated by the location map attached hereto.

**NOW, THEREFORE**, in consideration of the covenants and acknowledgments herein contained, the parties mutually agree as follows:

It is agreed that joint usage for both highway and utility purposes will be made of the area within the highway right of way limits as such area is defined and to the extent indicated on the aforementioned plans or sketches. Nothing in this Acknowledgment shall serve to modify or extinguish any compensable property interest vested in the **Utility** within the above described area. If the facilities shown in the aforementioned plans need to be altered or modified or new facilities constructed to either accommodate the proposed highway improvements or as part of **Utility’s** future proposed changes to its own facilities, **Utility** agrees to notify **TxDOT** at least 30 days prior thereto, and to furnish necessary plans showing location and type of construction, unless an emergency situation occurs and immediate action is required. If an emergency situation occurs and immediate action is required, **Utility** agrees to notify **TxDOT** promptly. If such alteration, modification or new construction is in using said highway, **TxDOT** shall have the right, after receipt of such notice, to prescribe such regulations as necessary for the protection of the highway facility and the traveling public using said highway. Such regulations shall not extend, however, to requiring the placement of intended overhead lines underground or the routing of any lines outside of the area of joint usage above described.

If **Utility’s** facilities are located along a controlled access highway, **Utility** agrees that ingress and egress for servicing its facilities will be limited to frontage roads where provided, nearby or adjacent public roads and streets, or trails along or near the highway right of way lines which only connect to an intersecting road. Entry may be made to the outer portion of the highway right of way from any one or all access points. Where supports, manholes or other appurtenances of the **Utility’s** facilities are located in medians or interchange areas, access from the through-traffic roadways or ramps will be allowed by permit issued by the **State** to the **Utility** setting forth the conditions for policing and other controls to protect highway users. In an emergency situation, if the means of access or service operations as herein provided will not permit emergency repairs as required for the safety and welfare of the public, the **Utility** shall have a temporary right of access to and from the through-traffic roadways and ramps as necessary to accomplish the required repairs, provided **TxDOT** is notified immediately highway traffic. Except as expressly provided herein, the **Utility’s** rights of access to the through-traffic roadways and/or ramps shall be subject to the same rules and regulations that apply to the general public.

If **Utility’s** facilities are located along a non-controlled access highway, the **Utility’s** rights of ingress and egress to the through-traffic roadways and/or ramps are subject to the same rules and regulations that apply to the general public.



**Participation in actual costs incurred by the Utility** for any future adjustment, removal or relocation of utility facilities required by highway construction shall be in accordance with applicable laws of the State of Texas.

**Utility** will, by written notice, advise **TxDOT** of the beginning and completion dates of the adjustment, removal or relocation, and thereafter, agrees to perform such work diligently, and to conclude said adjustment, removal or relocation by the stated completion date. The completion date shall be extended for delays caused by events outside **Utility's** control, including an event of Force Majeure, which shall include a strike, war or act of war (whether an actual declaration of war is made or not), insurrection, riot, act of public enemy, accident, fire, flood or other act of God, sabotage, or any other event in which **Utility** has exercised all due care in the prevention thereof so that the causes or other events are beyond the control and without the fault or negligence of **Utility**.

It is expressly understood that **Utility** conducts the new installation, adjustment, removal and/or relocation at its own risk and that **TxDOT** makes no warranties or representations regarding the existence or location of utilities currently within its right of way.

The **Utility** and the **State**, by execution of this Acknowledgment, do not waive or relinquish any right that they may have under the law.

The signatories to this Acknowledgment warrant that each has the authority to enter into this Acknowledgment on behalf of the party represented.

**IN WITNESS WHEREOF**, the parties hereto have affixed their signatures.

**UTILITY**

**EXECUTION RECOMMENDED:**

Utility: \_\_\_\_\_  
*Name of Utility*

\_\_\_\_\_  
District Engineer, District

By: \_\_\_\_\_  
*Authorized Signature*

**THE STATE OF TEXAS**

Executed and approved for the Texas Transportation Commission for the purpose and effect of activating and/or carrying out the orders, established policies or work programs heretofore approved and authorized by the Texas Transportation Commission.

By: \_\_\_\_\_  
Director, SPD Right of Way

Date: \_\_\_\_\_

\_\_\_\_\_  
*Print or Type Name*

Title: \_\_\_\_\_

Date: \_\_\_\_\_



## DB Contractor's Utility Design Coordinator

### Utility No Conflict Sign-Off Form

Utility Design Coordinator: \_\_\_\_\_  
 Date plans received: \_\_\_\_\_  
 Utility Company: \_\_\_\_\_  
 Assembly "U" number: \_\_\_\_\_  
 Type of Utilities: \_\_\_\_\_  
 Date on Utility's plans: \_\_\_\_\_      No. of sheets in Utility's plans: \_\_\_\_\_

I, \_\_\_\_\_, the Utility Design Coordinator (UDC) on behalf of the DB Contractor (\_\_\_\_\_) certify that a review of the above referenced Utility Plans concerning the proposed highway improvements on the \_\_\_\_\_ has been completed and have not identified any conflicts between the Utility's proposed relocation and any design features.

Design features include but are not limited to pavement structures, drainage facilities, bridges, retaining walls, traffic signals, illumination, signs, foundations, duct/conduit, ground boxes, erosion control facilities, water quality facilities and other DB Contractor-Managed Utilities.

Any design changes to the \_\_\_\_\_ after the signing of this form will be coordinated through the DB Contractor's Utility Manager and the affected Utility Owner.

Check box if any areas of concern and insert comments below:

Utility Design Coordinator: \_\_\_\_\_  
 (UDC) (Signature) \_\_\_\_\_ Date \_\_\_\_\_

\_\_\_\_\_  
 (Print Name)

Utility Coordination Firm: \_\_\_\_\_  
 (Print Name)

**This form must be completed/signed and included in each Utility Assembly submitted to the Texas Department of Transportation.**

Texas Department of Transportation  
Technical Provisions  
for  
SH 249 Extension

Attachment 11-1  
Cross Street Design Criteria

February 9, 2017



**Attachment 11-1:  
Cross Street Design Criteria**

Intersecting Street	Jurisdiction	Roadway Classification	Design Speed (mph)	Position (over/under)	Design Vehicle	Clear Zone for Cross Street	Curb and Gutter	Sidewalk and Min. Usable Width (LF)	Proposed Work						Future Cross Section							
									WESTBOUND*			Turn Lanes	Median	EASTBOUND*		WESTBOUND*			Turn Lanes	Median	EASTBOUND*	
									U-Turn** (each)	Through Lanes	Through Lanes			Through Lanes	U-Turn** (each)	U-Turn** (each)	Through Lanes	Through Lanes			U-Turn** (each)	
<b>Segment 1</b>																						
Rollingwood	Montgomery County	Rural Local	35	Under SH249	WB-50	6'	Y	N/A								0	1 (12')	N/A	N/A	1 (12')	0	
FM 1774 (in Pinehurst)	TxDOT	Urban Collector	55	Under SH249	WB-50	30'	Y	N/A								0	2 (12') 1 (14')	N/A	N/A	N/A	0	
Circle Lake Dr	Montgomery County	Rural Local	35	Under SH249	WB-50	6'	Y	N/A								0	1 (12')	N/A	N/A	1 (12')	0	
Future Terra Boulevard	Montgomery County	Rural Collector	40	Under SH249	WB-50	16'	N	N/A	0	2 (12')	2 (12')	4' Flush	2 (12')	0	0	2 (12')	2 (12')	4' Flush	2 (12')	0		
FM 149	TxDOT	Rural Collector	55	Under SH249	WB-50	30'	N	N/A	0	2 (12')	2 (12')	4' Flush	2 (12')	0	1	2(12')	2 (12')	4' Flush	2 (12')	1		
Mildred Lane	Montgomery County	Rural Local	30	Under SH249	WB-50	10'	N	N/A							0	1 (12')	N/A	N/A	1 (12')	0		
Future Thoroughfare (STA 1397+00)	Montgomery County	Rural Collector	40	Under SH249	WB-50	16'	N	N/A	0	2 (12')	2 (12')	4' Flush	2 (12')	0	1	2 (12')	2 (12')	4' Flush	2 (12')	1		
FM 1488	TxDOT	Rural Collector	55	Under SH249	WB-50	30'	N	N/A	0	2 (12')	2 (12')	4' Flush	2 (12')	0	1	2 (12')	2 (12')	4' Flush	2 (12')	1		
Future Thoroughfare (STA 1515+00)	Montgomery County	Rural Collector	40	Under SH249	WB-50	16'	N	N/A							1	2 (12')	2 (12')	4' Flush	2 (12')	1		
Future Thoroughfare (STA 1574+50)	Montgomery County	Rural Collector	40	Under SH249	WB-50	16'	N	N/A							1	2 (12')	2 (12')	4' Flush	2 (12')	1		
FM1486	TxDOT	Rural Collector	55	Under SH249	WB-50	30'	N	N/A	0	2 (12')	2 (12')	4' Flush	2 (12')	0	1	2 (12')	2 (12')	4' Flush	2 (12')	1		
Future Thoroughfare (STA 1749+25)	Montgomery County	Rural Collector	40	Under SH249	WB-50	16'	N	N/A							1	2 (12')	2 (12')	4' Flush	2 (12')	1		
Future Thoroughfare (STA 1842+00)	Montgomery County	Rural Collector	40	Under SH249	WB-50	16'	N	N/A							0	2 (12')	2 (12')	4' Flush	2 (12')	0		
FM 1774 (in Todd Mission)	TxDOT	Urban Collector	50	Under SH 249	WB-67	30'	N	N/A	0	1 (12')	2 (12')	4' Flush	1 (12')	0	0	2(12')	2 (12')	4' Flush	2 (12')	0		
<b>Segment 2</b>																						
Urbanosky Lane	Private Road	Other	30	Under SH 249	WB-67	10'	N	N/A	0	1 (12')	N/A	N/A	1 (12')	1	0	1 (12')	N/A	N/A	1 (12')	1		
Pinebrook South Access	Private Road	Other	30	Under SH 249	WB-67	10'	N	N/A	0	1 (12')	N/A	N/A	1 (12')	0	1	1 (12')	N/A	N/A	1 (12')	1		
CR 304	Grimes County	Rural Local	30	Under SH 249	WB-67	10'	N	N/A	1	1 (12')	N/A	N/A	1 (12')	1	1	1 (12')	2 (12')	N/A	1 (12')	1		
NB to SB access road turnaround	TxDOT	Rural Local	15	Under SH 249	SU	6.5'	Y	N/A	1	N/A	N/A	N/A	N/A	0	1	N/A	N/A	N/A	N/A	0		
CR 307	Grimes County	Rural Local	30	Under SH 249	WB-67	10'	N	N/A	0	1 (12')	N/A	N/A	1 (12')	0	1	1 (12')	N/A	N/A	1 (12')	0		
CR 306	Grimes County	Rural Local	30	Under SH 249	WB-67	10'	N	N/A	0	1 (12')	N/A	N/A	1 (12')	0	0	1 (12')	2 (12')	N/A	1 (12')	0		
FM 1748	TxDOT	Rural Collector	40	Under SH 249	WB-67	10'	N	N/A	0	1 (12')	N/A	N/A	1 (12')	0	0	1 (12')	N/A	N/A	1 (12')	0		
U-Turns**	TxDOT	Rural Local	15	Under SH 249	SU	6.5'	Y	N/A														

\* ALL CROSS ROADS ARE ASSUMED TO BE WESTBOUND/EASTBOUND IN RELATIONSHIP TO SH249 BEING NORTHBOUND/SOUTHBOUND.

\*\*ALL U-TURNS HAVE THE FOLLOWING CRITERIA

Texas Department of Transportation  
Technical Provisions  
for  
SH 249 Extension

Attachment 11-2  
Proposed Cross Street Typical Sections

February 9, 2017

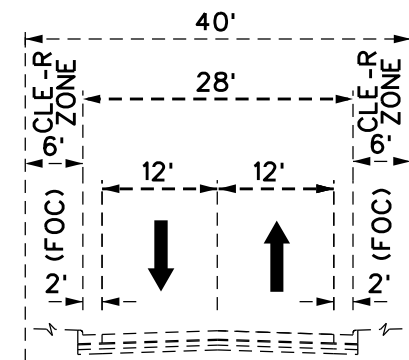

ROLLINGWOOD STREET &  
CIRCLE L-KE DRIVE

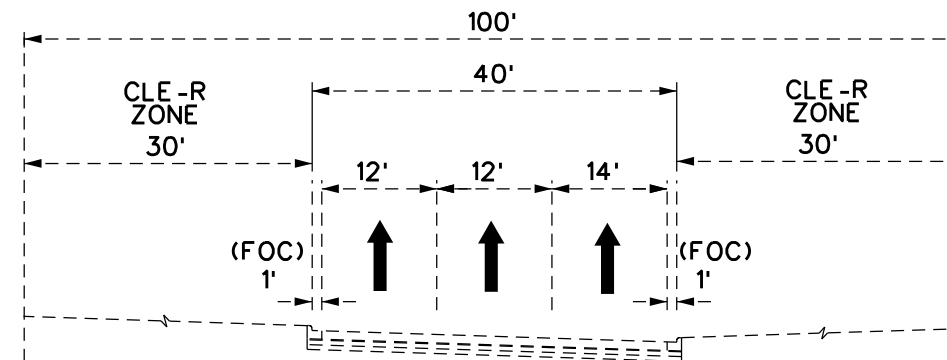

FM 1774 (PINEHURST)

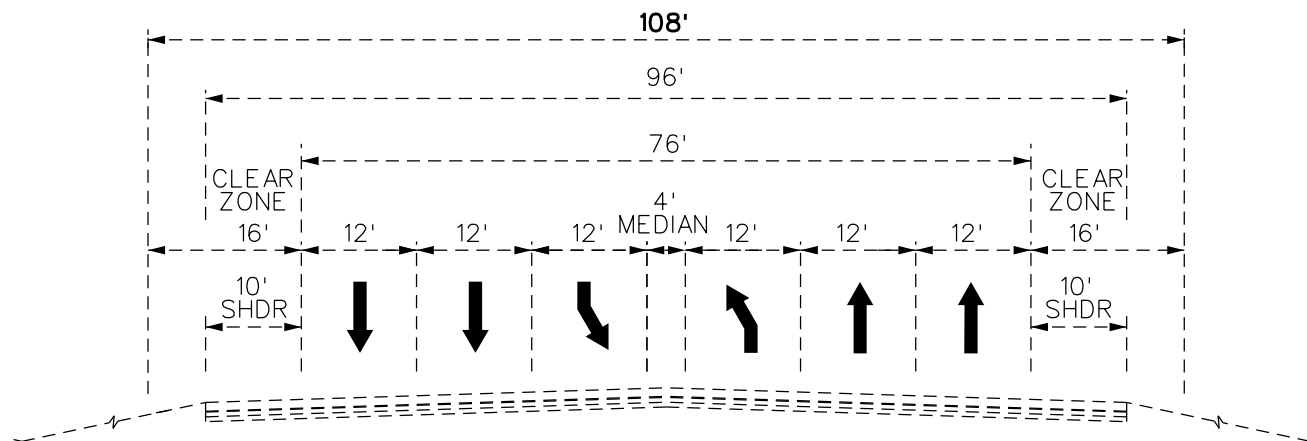

FUTURE TERR- BOULEV-RD (ST- 1228+00) &  
FUTURE THOROUGHF-RE (ST- 1842+00)

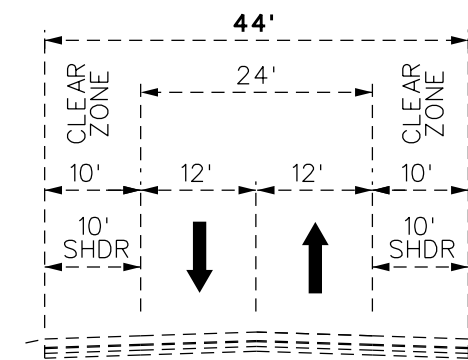

MILDRED L-NE

**LEGEND**

- PROPOSED CONSTRUCTION
- - - PL-NNED (FUTURE) CONSTRUCTION

**NOTE:**

TYPIC-L SECTIONS PROVIDE  
FUTURE CROSS STREET  
REQUIREMENT DET-ILS NEEDED  
TO DEVELOP SH 249  
OVERP-SS STRUCTURES.

**SH 249 EXTENSION  
TECHNICAL PROVISIONS  
ATTACHMENT 11-2:  
SEGMENT 1  
PROPOSED CROSS STREET  
TYPICAL SECTIONS**

SHEET 1 OF 5

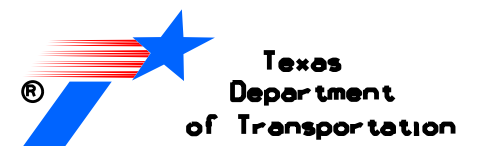

NOT TO SC-LE

PRELIMIN-RY SUBJECT TO CH-NGE

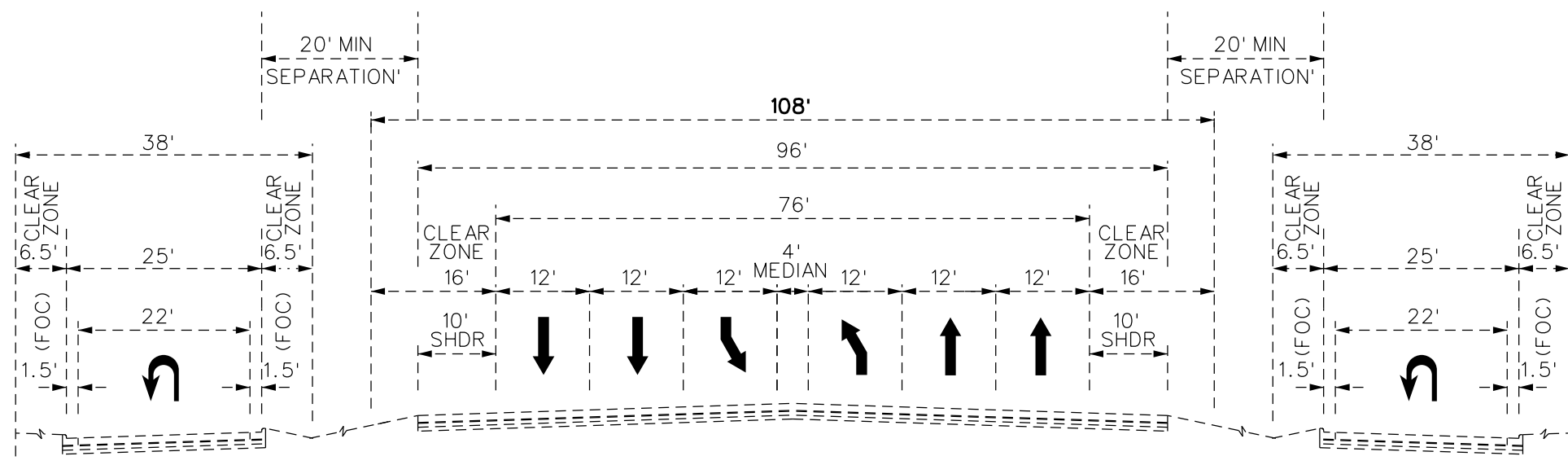

FUTURE THOROUGH-RE (ST- 1397+00 & 1515+00 & 1574+00 & 1749+25)

**LEGEND**

- PROPOSED CONSTRUCTION
- - - PL-NNED (FUTURE) CONSTRUCTION

**NOTE:**

TYPIC-L SECTIONS PROVIDE FUTURE CROSS STREET REQUIREMENT DET-ILS NEEDED TO DEVELOP SH 249 OVERP-SS STRUCTURES.

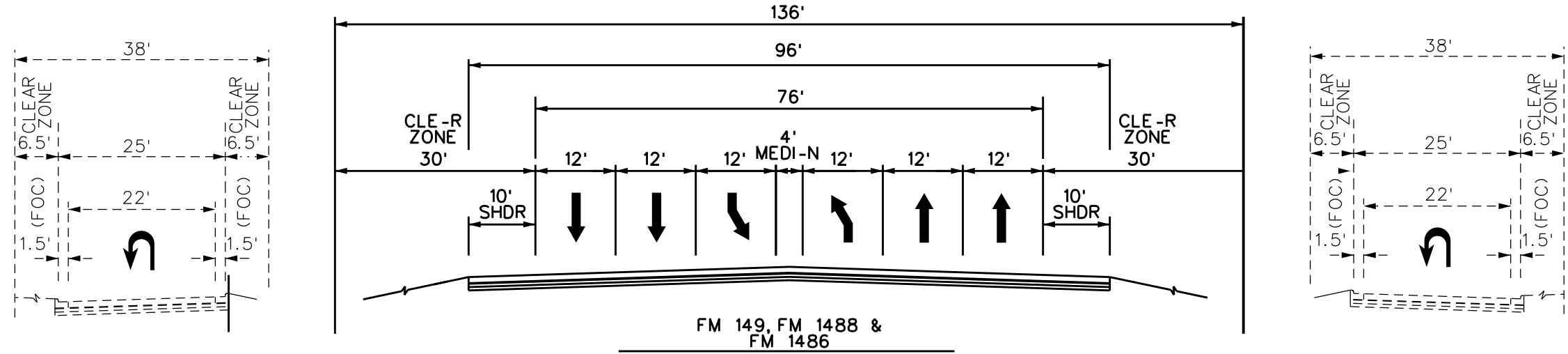

**SH 249 EXTENSION  
TECHNICAL PROVISIONS  
ATTACHMENT 11-2:  
SEGMENT 1  
PROPOSED CROSS STREET  
TYPICAL SECTIONS**

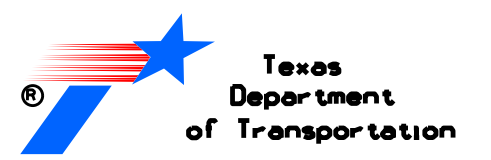

NOT TO SC-LE

PRELIMINARY SUBJECT TO CHANGE

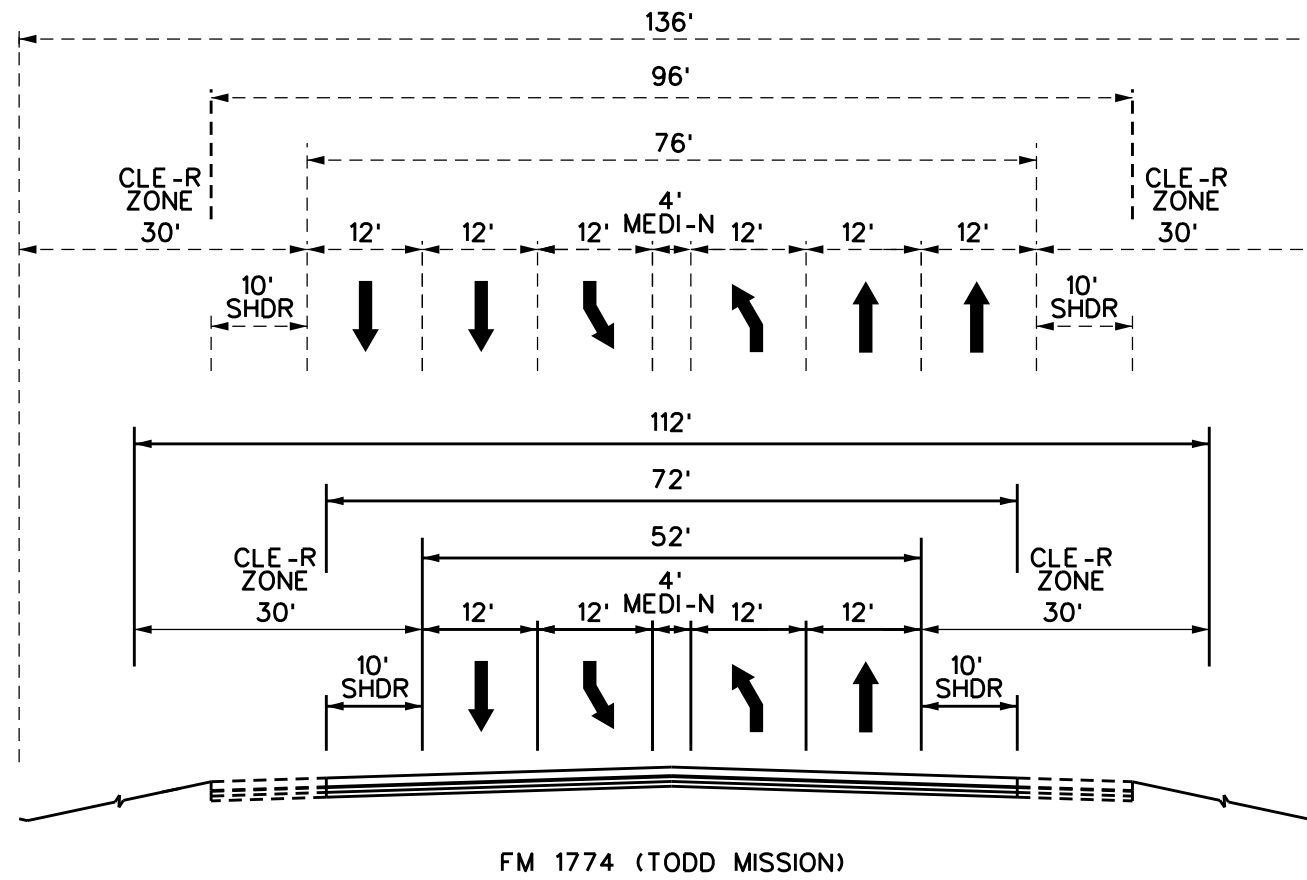

**LEGEND**

- PROPOSED CONSTRUCTION
- - - PL-NNED (FUTURE) CONSTRUCTION

**NOTE:**

TYPIC-L SECTIONS PROVIDE FUTURE CROSS STREET REQUIREMENT DET-ILS NEEDED TO DEVELOP SH 249 OVERP-SS STRUCTURES.

**SH 249 EXTENSION  
TECHNICAL PROVISIONS  
ATTACHMENT 11-2:  
SEGMENT 1  
PROPOSED CROSS STREET  
TYPICAL SECTIONS**

SHEET 3 OF 5

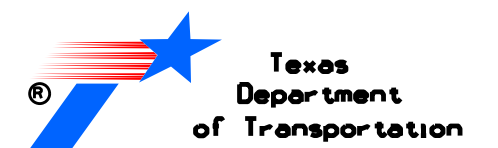

NOT TO SC-LE

PRELIMINARY SUBJECT TO CHANGE

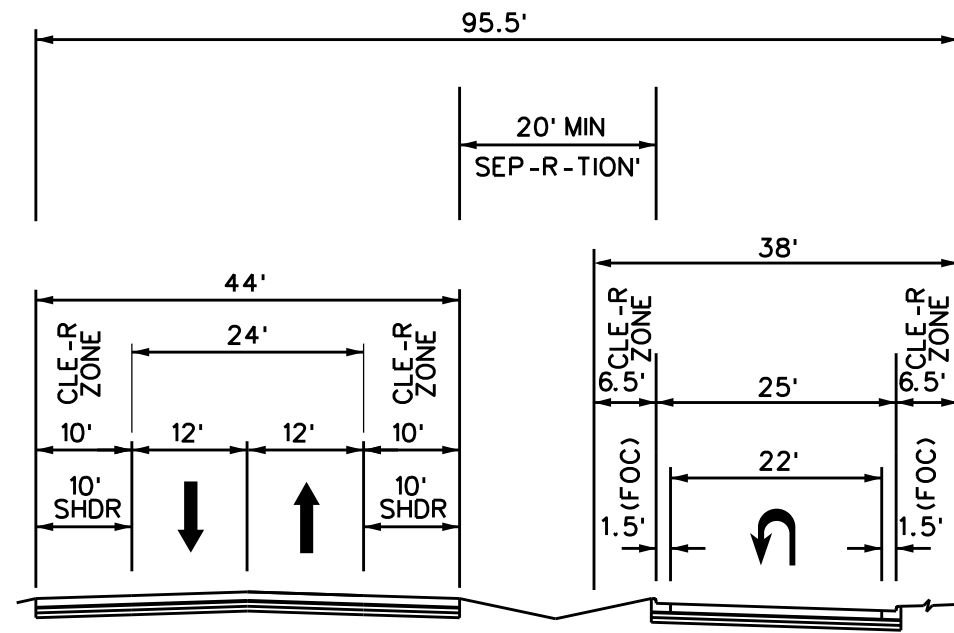

URB-NOSKY L-NE

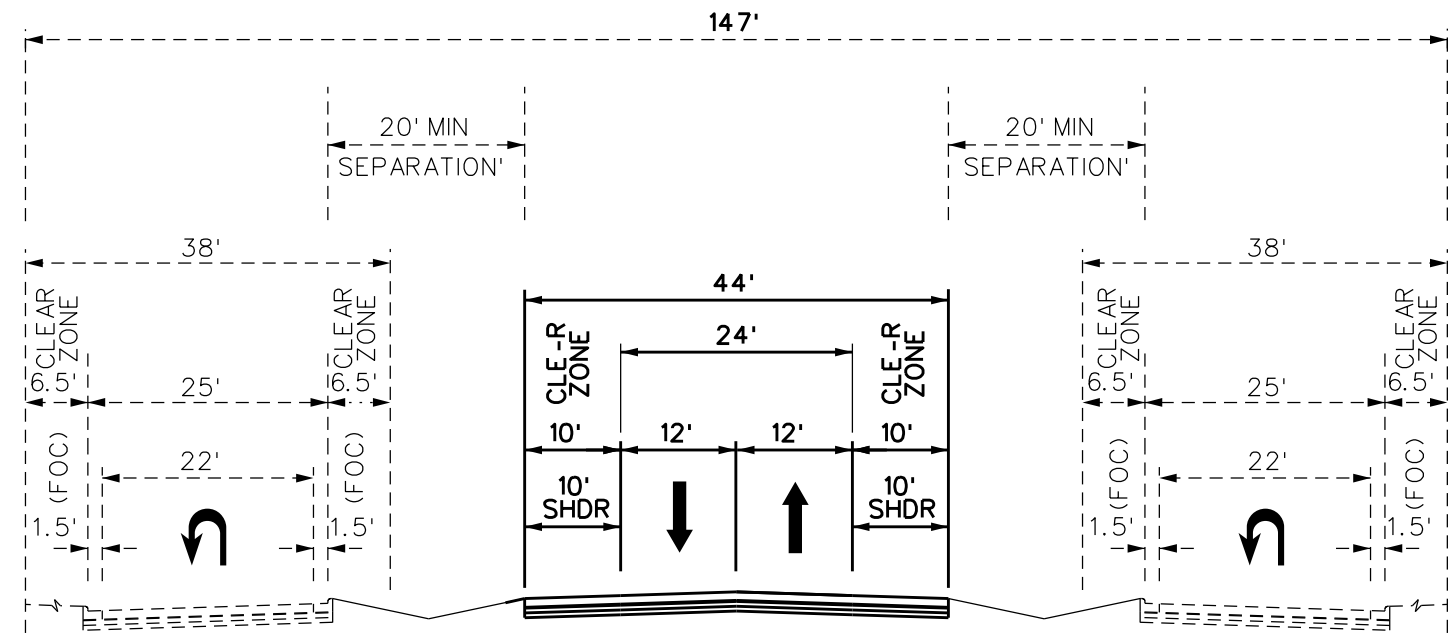

PINEBROOK SOUTH -CCESS

**LEGEND**

- PROPOSED CONSTRUCTION
- - - PL-NNED (FUTURE) CONSTRUCTION

**NOTE:**

TYPIC-L SECTIONS PROVIDE FUTURE CROSS STREET REQUIREMENT DET-ILS NEEDED TO DEVELOP SH 249 OVERP-SS STRUCTURES.

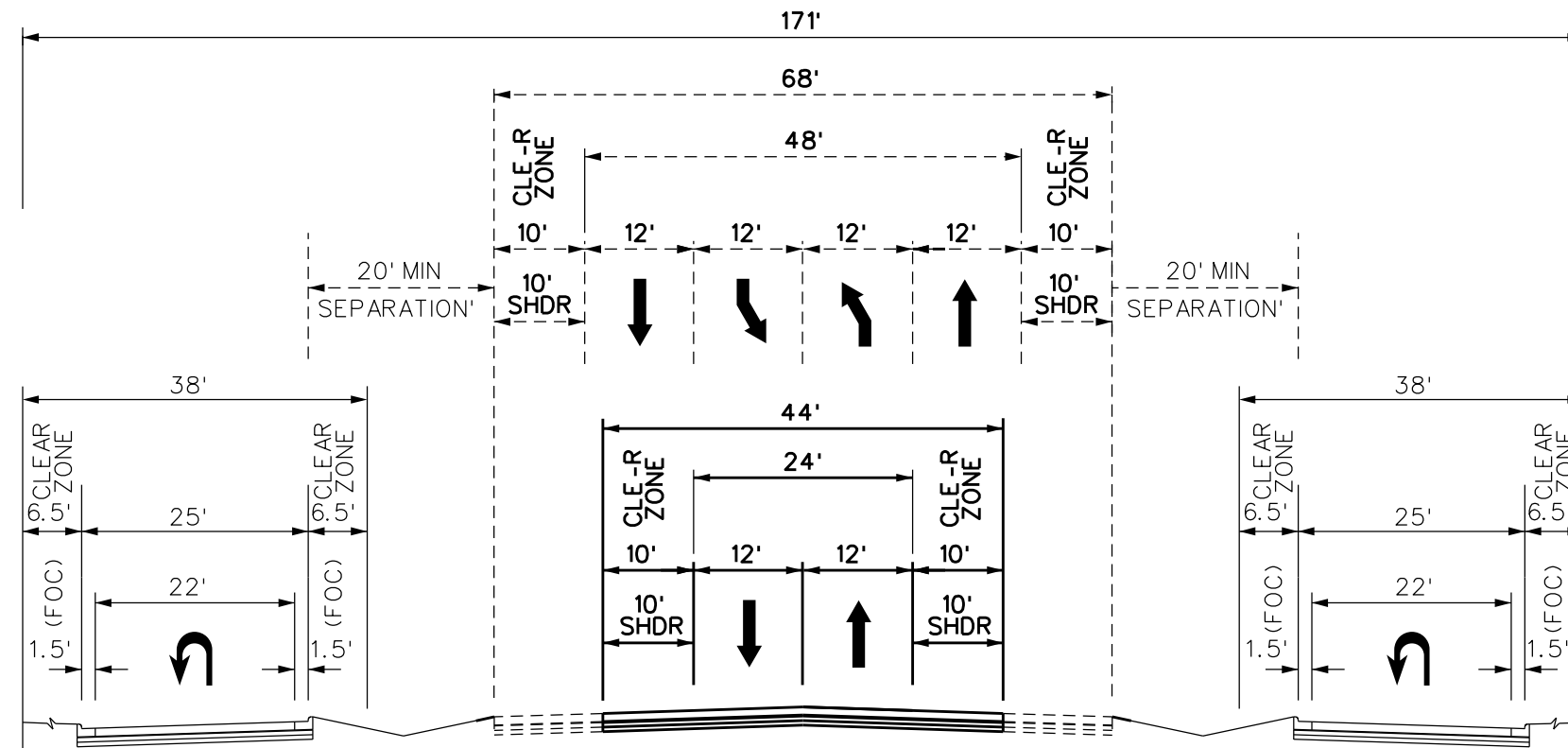

CR 304

**SH 249 EXTENSION  
TECHNICAL PROVISIONS  
ATTACHMENT 11-2:  
SEGMENT 2  
PROPOSED CROSS STREET  
TYPICAL SECTIONS**

SHEET 4 OF 5

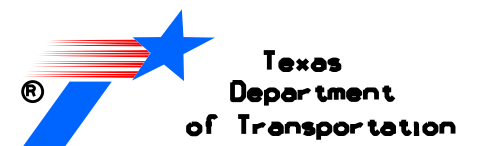

NOT TO SC-LE

PRELIMIN-RY SUBJECT TO CH-NGE

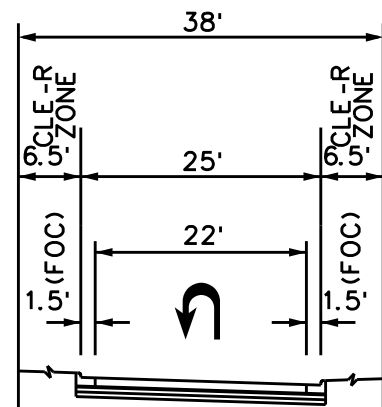

NB TO SB -ACCESS RO-D TURN-ROUND

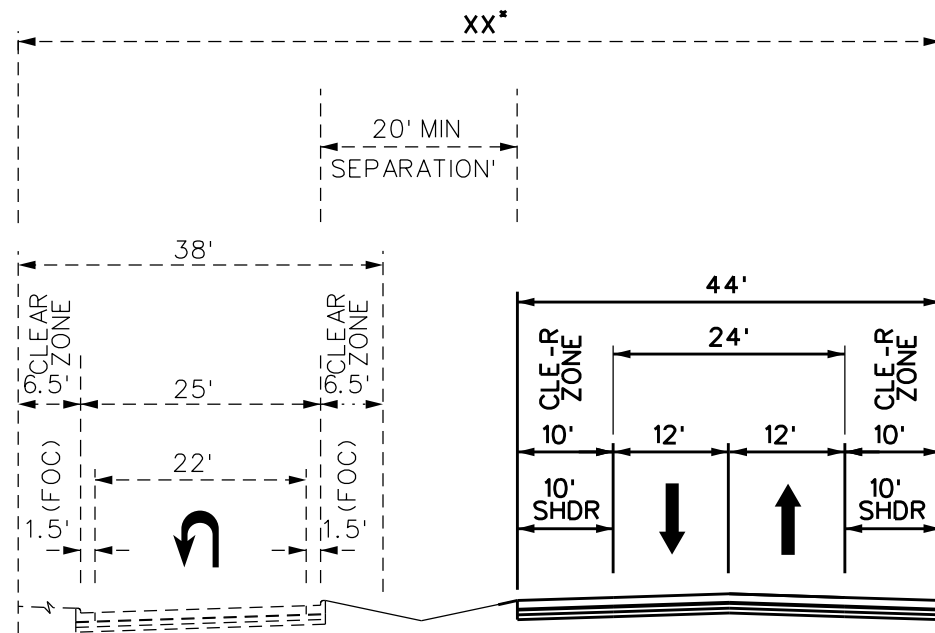

CR 307 - UNDER SH 249

\*BRIDGE SPAN(S) SHALL ACCOMMODATE THE EXISTING UTILITES AND CONSTRUCTION OF A FUTURE TURNAROUND. ADJUSTMENT OF THE EXISTING UTILITES IS NOT REQUIRED TO ACCOMMODATE THE FUTURE TURNAROUND.

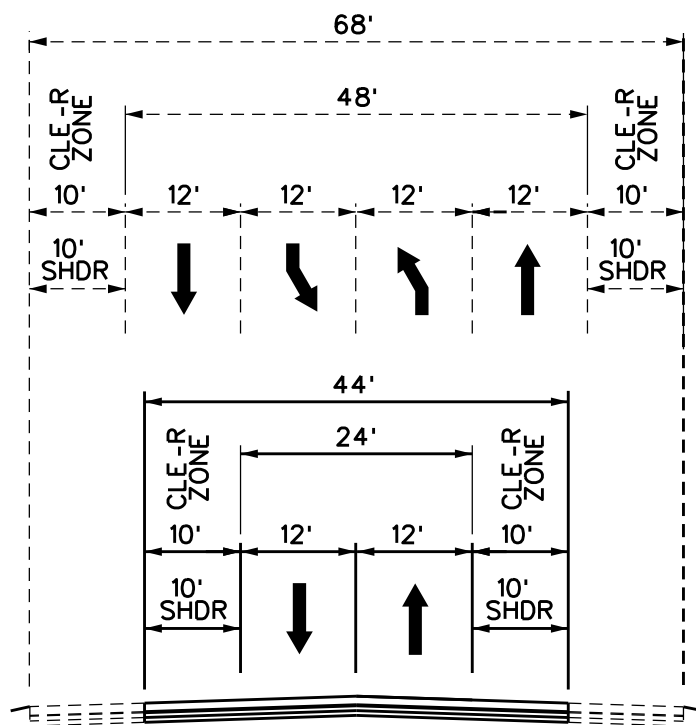

CR 306

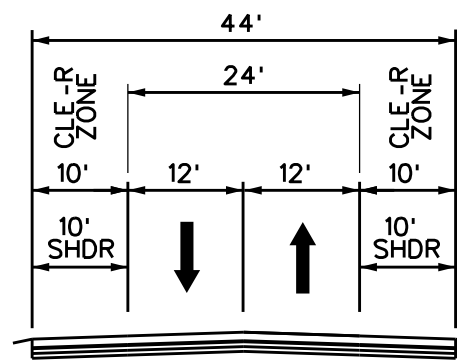

FM 1748

LEGEND

- PROPOSED CONSTRUCTION
- - - PL-NNED (FUTURE) CONSTRUCTION

NOTE:

TYPICAL SECTIONS PROVIDE FUTURE CROSS STREET REQUIREMENT DET-ILS NEEDED TO DEVELOP SH 249 OVERP-SS STRUCTURES.

**SH 249 EXTENSION  
TECHNICAL PROVISIONS  
ATTACHMENT 11-2:  
SEGMENT 2  
PROPOSED CROSS STREET  
TYPICAL SECTIONS**

SHEET 5 OF 5

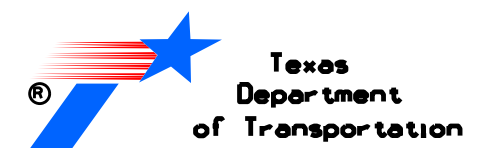

NOT TO SC-LE

PRELIMIN-RY SUBJECT TO CH-NGE

Texas Department of Transportation  
Technical Provisions  
for  
SH 249 Extension

Attachment 17-1  
Preliminary Layout for Environmental  
Communications Building Locations

February 9, 2017



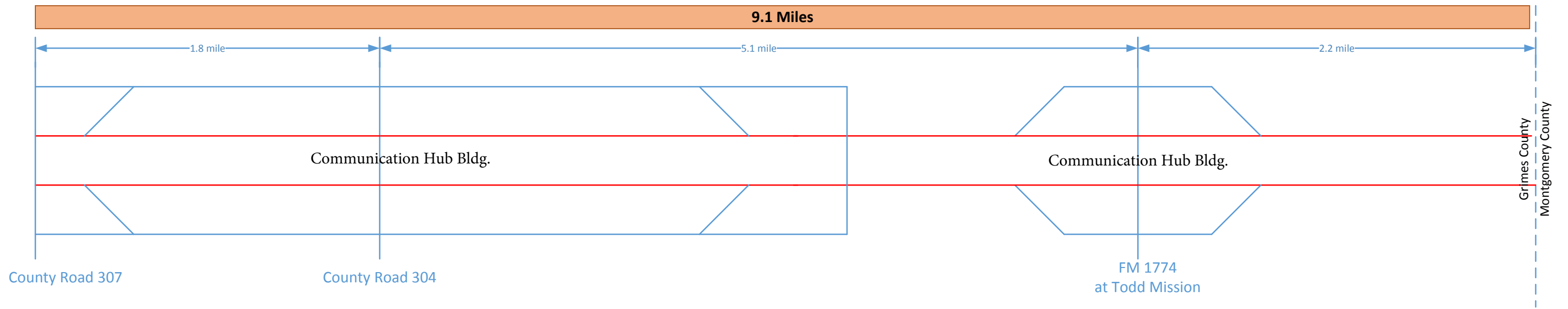
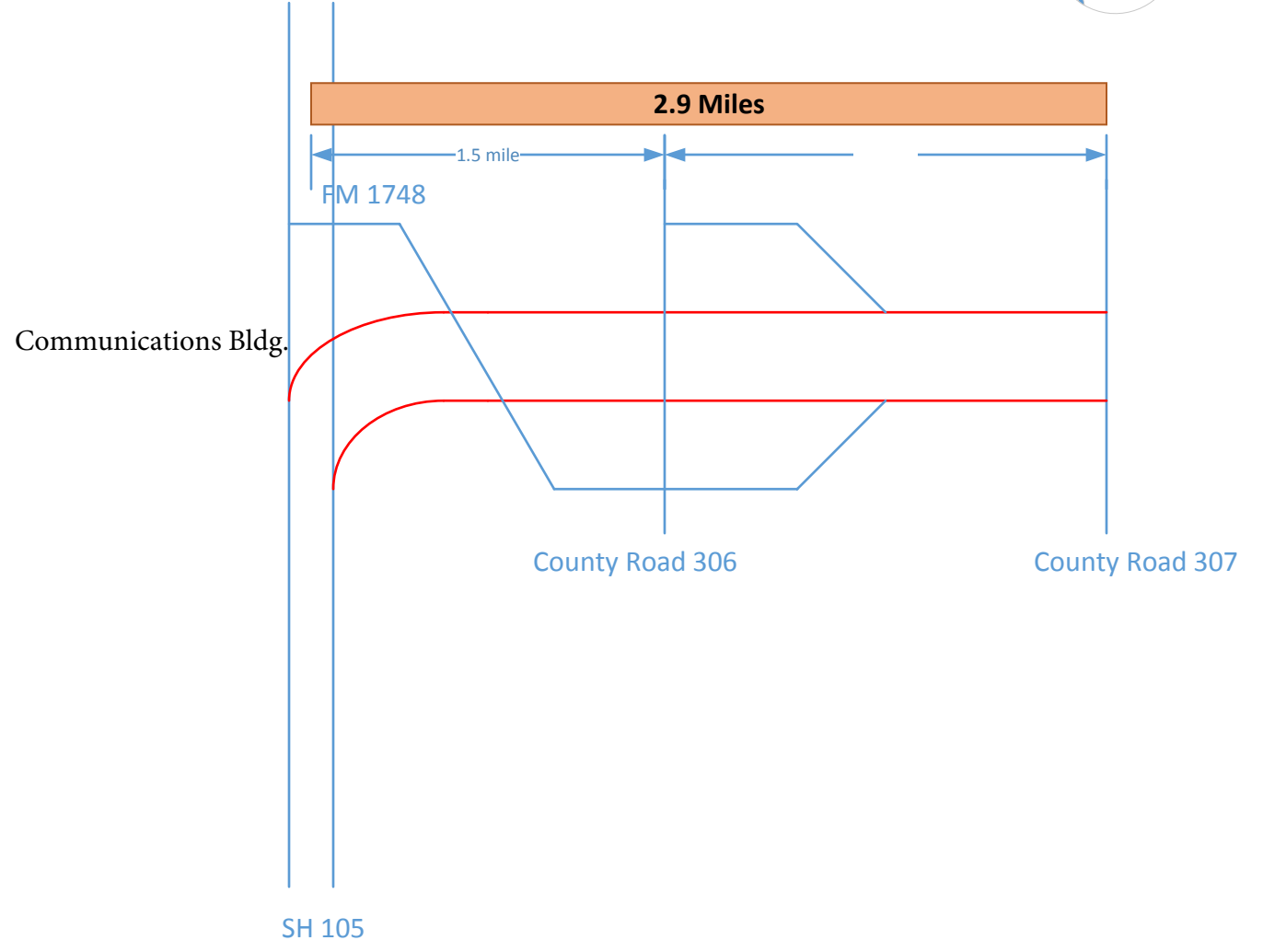
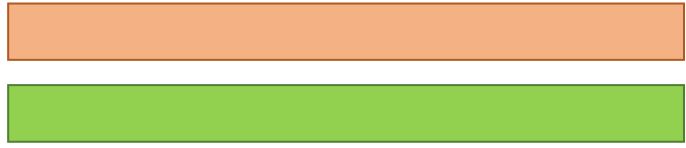
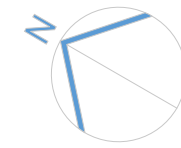

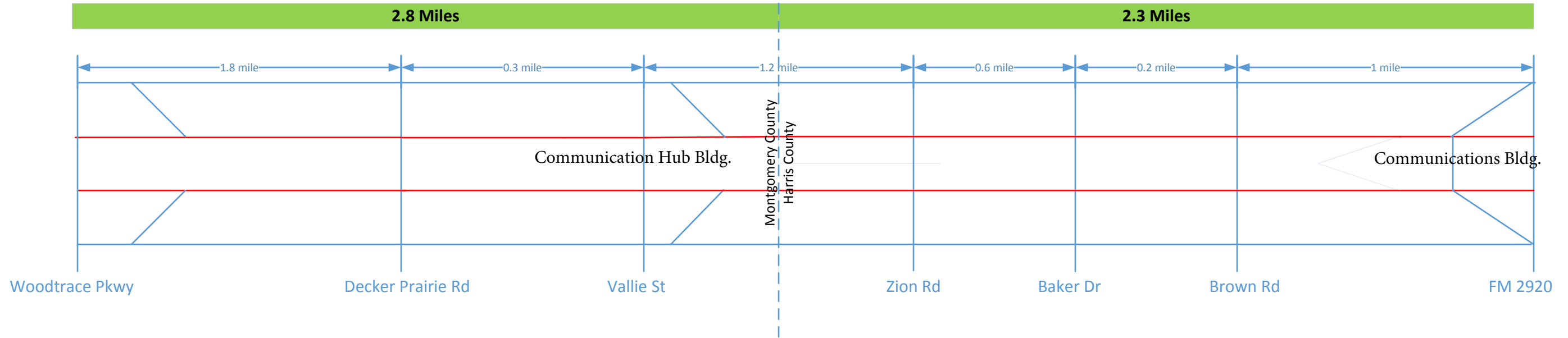
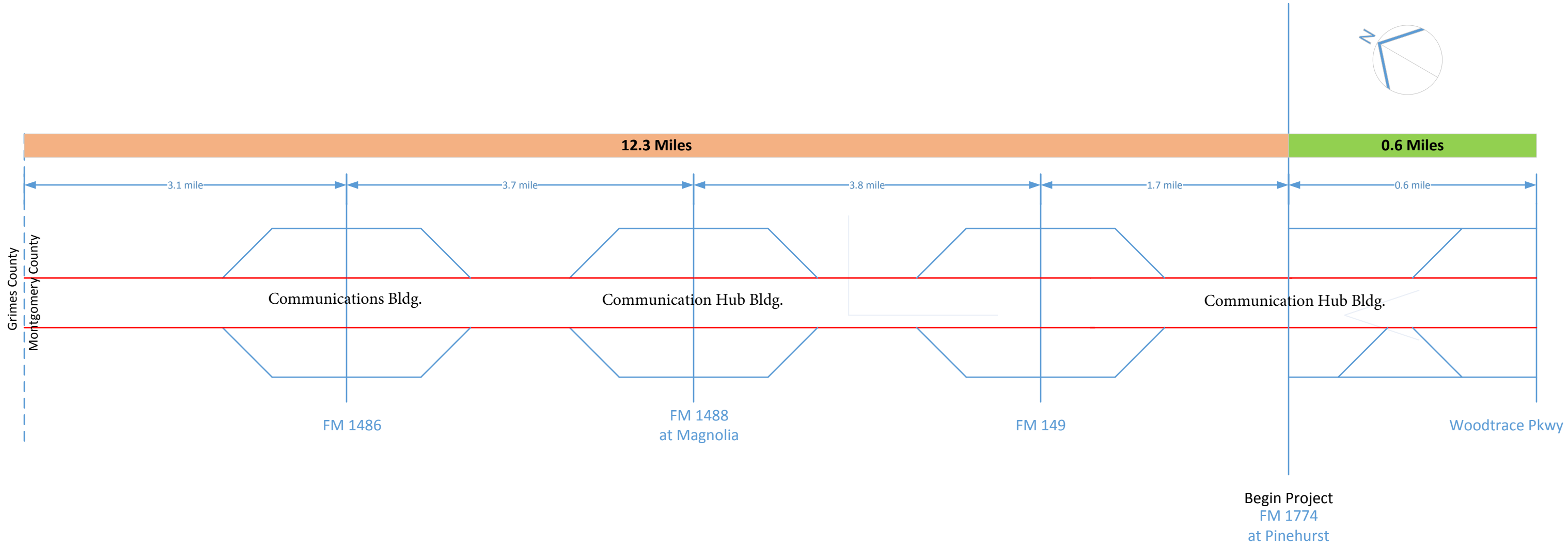

Texas Department of Transportation  
Technical Provisions  
for  
SH 249 Extension

Attachment 18-1  
TxDMV Motor Carrier Division  
Permit Restriction Application

February 9, 2017



# Motor Carrier Division Permit Restriction Application

Rev. 7/2012

District Number:	District Name:
------------------	----------------

New Restriction <input type="checkbox"/>	Amend Restriction <input type="checkbox"/>	Cancel Restriction <input type="checkbox"/>
--	--	---

Highway: \_\_\_\_\_ County: \_\_\_\_\_

From junction: \_\_\_\_\_

To junction: \_\_\_\_\_

Direction(s) affected: Northbound  Southbound  Eastbound  Westbound

Turns affected:

*Maximum dimensions allowed. If a dimension is not affected, please put N/A in the space provided.  
Please enter dimensions in feet and inches DO NOT enter "legal."*

Width:	Height:	Overall Length:	Trailer Length:
Weight:	Overweight ONLY is Okay:		

*NOTE: Do not over restrict your highways; loads with small dimensions might safely travel through the restricted area without any inconvenience to the construction crew and/or the traveling public.*

Start date: \_\_\_\_\_ End date: \_\_\_\_\_

Type of work or reason:

Construction:  Maintenance:  Sealcoat:  Safety: (physical limits)  Other:

Comments:

Approved by: \_\_\_\_\_ Date: \_\_\_\_\_

Date restriction lifted: \_\_\_\_\_ Approved by: \_\_\_\_\_

MCD Mapping Coordinator phone: 512-302-2166  
e-mail: [mcd\\_permit-restriction-@txdmv.gov](mailto:mcd_permit-restriction-@txdmv.gov)

*We cannot correctly restrict your roadway unless this form is filled out completely.*

Texas Department of Transportation  
Technical Provisions  
for  
SH 249 Extension

Attachment 19-1  
Performance and Measurement Table

February 9, 2017

**ATTACHMENT 19-1: PERFORMANCE AND MEASUREMENT TABLE**

ELEMENT CATEGORY	REF	ELEMENT	PERFORMANCE OBJECTIVE	DEFECT REMEDY PERIOD			INSPECTION AND MEASUREMENT METHOD	REF	MEASUREMENT RECORD	TARGET
				Cat 1	Cat 1	Cat 2				
				Hazard Mitigation	Permanent Remedy	Permanent Repair				
<b>1) PAVEMENT</b>										
								<i>Unless stated otherwise, measurements shall be conducted using procedures, techniques, and measuring equipment consistent with TxDOT's Pavement Management Information System Rater's Manual. Unless otherwise stated, pavement performance measurement records relate to 0.1-mile sections as described in the Pavement Management Information System Rater's Manual.</i>		
1.1		Ruts	All roadways are free from surface depressions exceeding measurement record thresholds.	24 hours	28 days	28 days	Physical measurement	1.1.1	No percentage of wheel path length with ruts greater than the reference condition (on a location-specific basis) in the BECR.	100%
								1.1.2	No depth of rut at any location greater than the reference condition (on a location-specific basis) in the BECR.	100%
1.2		Ride quality	All roadways have a smooth surface course (including bridge decks, covers, gratings, frames and boxes).	24 hours	28 days	28 days	10-ft straight edge used to measure discontinuities.	1.2.1	No individual discontinuities greater than the reference condition (on a location-specific basis) in the BECR.	100%
1.3		Cracking	All roadways are free from cracking exceeding measurement record thresholds.	24 hours	28 days	28 days	Physical measurement	1.3.1	No unsealed longitudinal cracking and/or transverse cracking in any Performance Section with a width greater than the reference condition (on a location-specific basis) in the BECR.	100%
1.4		Raveling	All roadways are free from raveling exceeding measurement record thresholds.	Not used	Not used	Not used	Not used	1.4.1	Not used	Not used
1.5		Flushing	All roadways are free from flushing exceeding measurement record thresholds.	Not used	Not used	Not used	Not used	1.5.1	Not used	Not used
1.6		Failures	All roadways are free from failures.	24 hours	28 days	N/A	Physical measurement	1.6.1	No failures exceeding the failure criteria set forth in the TxDOT PMIS Rater's Manual including potholes, base failures, punchouts and jointed concrete pavement failures.	100%
1.7		Edge drop-offs	All roadways are free from edge drop-offs exceeding measurement record thresholds.	24 hours	28 days	28 days	Physical measurement	1.7.1	No edge drop-off greater than the reference condition (on a location-specific basis) in the BECR.	100%
1.8		Skid resistance	All roadways have adequate skid resistance.	Not used	Not used	Not used	Not used	1.8.1	Not used	Not used
			Road users warned of potential skidding hazards.	24 hours	7 days	N/A	Records potential skidding hazards where remedial action is identified	1.8.2	Road Users warned of potential skidding hazard where remedial action is identified.	100%
1.9		Joints in concrete	All joints exceeding measurement record thresholds in concrete paving are sealed.	Not used	Not used	Not used	Not used	1.9.1	Not used	Not used
			No longitudinal joint separation and discontinuity exceeding measurement record thresholds.				Not used	1.9.2	Not used	Not used
<b>2) DRAINAGE</b>										
2.1		Pipes, ditches, channels, catch basins, inlets, manholes and outfalls	Each element of the drainage system is maintained in its proper function by cleaning, clearing and/or emptying as appropriate including any vegetation, debris and silt from the point at which water drains from the travel way to the outfall or drainage way.	24 hours	28 days	28 days	Visual inspection	2.1.1	The general condition is at least equal to the reference condition (on a location-specific basis) in the BECR.	100%
2.2		Drainage treatment devices	Drainage treatment and balancing systems, flow and spillage control devices function correctly, are free of silt and debris and their location and means of operation is recorded adequately to permit their correct operation in Emergency.	24 hours	28 days	28 days	Visual inspection	2.2.1	The general condition is at least equal to the reference condition (on a location-specific basis) in the BECR.	100%

ATTACHMENT 19-1: PERFORMANCE AND MEASUREMENT TABLE

ELEMENT CATEGORY	REF	ELEMENT	PERFORMANCE OBJECTIVE	DEFECT REMEDY PERIOD			INSPECTION AND MEASUREMENT METHOD	REF	MEASUREMENT RECORD	TARGET
				Cat 1	Cat 1	Cat 2				
				Hazard Mitigation	Permanent Remedy	Permanent Repair				
	2.3	Travel way	The travel way is free from water to the extent that such water would represent a hazard because of its position or depth.	24 hours	28 days	6 months	Visual inspection	2.3.1	Performance objective met.	100%
	2.4	Discharge systems	Surface water discharge systems perform their proper function and discharge to groundwater and waterways complies with the relevant legislation and permits.	24 hours	28 days	3 months	Visual inspection	2.4.1	Performance objective met.	100%
	2.5	Protected species	Named species and habitats are protected.	24 hours	28 days	6 months	Visual inspection	2.5.1	Performance objective met.	100%
	2.6	Erosion	Address erosion greater than 12" deep along ditches, swales, ponds, and channels.	24 hours	28 days	28 days	Visual inspection	2.6.1	The general condition is at least equal to the reference condition (on a location-specific basis) in the BECR.	100%
	2.7	Channels and ditches – Permanent Erosion Control Measures	Where permanent erosion control measures such as rock or concrete riprap are utilized: free of undermined or damaged erosion control measures.	24 hours	28 days	28 days	Visual inspection	2.7.1	The general condition is at least equal to the reference condition (on a location-specific basis) in the BECR.	100%
<b>3) STRUCTURES</b>										
	3.1	Structure components (Structures having an opening measured along the center of the roadway of more than 20 feet between faces of abutments or spring lines of arches or extreme ends of the openings for multiple box culverts or multiple pipes that are 60 inches or more in diameter and that have a clear distance between openings of less than half of the smallest pipe diameter)	(i) Substructures and superstructures are free of: <ul style="list-style-type: none"> <li>• undesirable vegetation</li> <li>• debris and bird droppings</li> <li>• blocked drains, weep pipes, manholes and chambers</li> <li>• blocked drainage holes in structural components</li> <li>• defects in joint sealants</li> <li>• defects in pedestrian protection measure</li> <li>• scour damage</li> <li>• corrosion of rebar</li> <li>• paint system failures</li> <li>• impact damage</li> </ul> (ii) Expansion joints free of: <ul style="list-style-type: none"> <li>• dirt, debris and vegetation</li> <li>• defects in drainage system</li> <li>• loose nuts and bolts</li> <li>• defects in gaskets and/or seals</li> </ul> (iii) The deck drainage system is free of all debris and operates as intended. (iv) Parapets free of: <ul style="list-style-type: none"> <li>• loose nuts and bolts</li> <li>• blockages of hollow section drain holes</li> <li>• undesirable vegetation</li> <li>• impact damage</li> <li>• concrete spalling</li> </ul> v) Bearings and bearing seats are: <ul style="list-style-type: none"> <li>• properly aligned horizontally and vertically</li> <li>• clean and in full contact with each other</li> </ul> (vi) Sliding and roller surfaces are clean and greased to ensure satisfactory performance. Additional advice contained in bearing manufacturers' instructions in the structure maintenance manual is followed. (vii) Special finishes are clean and perform to the appropriate standards. (viii) All non-structural items such as hoists and electrical fixings, operate correctly, are clean and lubricated as appropriate, in accordance with the manufacturer's recommendations and certification of lifting devices is maintained.	Not used	Not used	Not used	Not used	3.1.1	Not used	Not used

**ATTACHMENT 19-1: PERFORMANCE AND MEASUREMENT TABLE**

ELEMENT CATEGORY	REF	ELEMENT	PERFORMANCE OBJECTIVE	DEFECT REMEDY PERIOD			INSPECTION AND MEASUREMENT METHOD	REF	MEASUREMENT RECORD	TARGET
				Cat 1	Cat 1	Cat 2				
				Hazard Mitigation	Permanent Remedy	Permanent Repair				
	3.2	Non-bridge class culverts	Non-bridge class culverts are free of: <ul style="list-style-type: none"> <li>• vegetation, debris and silt</li> <li>• defects in sealant at movement joints</li> <li>• scour damage</li> <li>• corrosion of rebar</li> <li>• impact damage</li> </ul>	Not used	Not used	Not used	Not used	3.2.1	Not used	Not used
	3.3	Load ratings	All structures maintain the design load capacity and no load restrictions for Texas legal loads (including legally permitted vehicles).	Not used	Not used	Not used	Not used	3.3.1	Not used	Not used
	3.4	Gantries and high-masts	Sign signal gantries, high-masts are structurally sound and free of: <ul style="list-style-type: none"> <li>• loose nuts and bolts</li> <li>• defects in surface protection systems</li> </ul>	Not used	Not used	Not used	Not used	3.4.1	Not used	Not used
	3.5	Access points	All hatches and points of access have fully operational and lockable entryways.	Not used	Not used	Not used	Not used	3.5.1	Not used	Not used
	3.6	Retaining walls	Retaining walls are free of: <ul style="list-style-type: none"> <li>• undesirable vegetation</li> <li>• defects in sealed joints</li> <li>• defects in pedestrian protection</li> <li>• scour damage</li> <li>• corrosion of rebar</li> <li>• paint system failure</li> <li>• concrete spalling</li> <li>• impact damage</li> <li>• blocked weep holes</li> </ul> Parapets are free of: <ul style="list-style-type: none"> <li>• loose nuts and bolts</li> <li>• blockage of drain holes</li> <li>• undesirable vegetation</li> <li>• impact damage</li> <li>• concrete spalling</li> </ul>	Not used	Not used	Not used	Not used	3.6.1	Not used	Not used
<b>4) PAVEMENT MARKINGS, OBJECT MARKERS, BARRIER MARKERS AND DELINEATORS</b>										
	4.1	Pavement markings	Pavement markings are: <ul style="list-style-type: none"> <li>• clean and visible during the day and at night</li> <li>• whole and complete and of the correct color, type, width and length</li> <li>• placed to meet the TMUTCD and TxDOT's Pavement Marking Standard Sheets</li> </ul>	24 hours	28 days	28 days	<b>a) Markings - General</b>			
							Visual inspection (to include a record of visibility of markings under low beam headlights.)	4.1.1	Marking visibility condition meets or exceeds the reference condition (on a location-specific basis) in the BECR.	100%
							Physical measurement	4.1.2	Length of pavement marking where the loss of pavement marking material is at least equal to the reference condition (on a location-specific basis) in the BECR.	100%
<b>b) Profile Markings</b>										
							Visual inspection	4.1.3	The general condition is at least equal to the reference condition (on a location-specific basis) in the BECR.	100%



**ATTACHMENT 19-1: PERFORMANCE AND MEASUREMENT TABLE**

ELEMENT CATEGORY	REF	ELEMENT	PERFORMANCE OBJECTIVE	DEFECT REMEDY PERIOD			INSPECTION AND MEASUREMENT METHOD	REF	MEASUREMENT RECORD	TARGET
				Cat 1	Cat 1	Cat 2				
				Hazard Mitigation	Permanent Remedy	Permanent Repair				
	4.2	Raised reflective markers	Raised reflective pavement markers are: <ul style="list-style-type: none"> <li>• clean and clearly visible</li> <li>• of the correct color and type</li> <li>• reflective or retroreflective in accordance with TxDOT standards</li> <li>• correctly located, aligned and at the correct level</li> <li>• are firmly fixed</li> <li>• are in a condition that will ensure that they remain at the correct level.</li> </ul>	24 hours	28 days	6 months	Visual inspection	4.2.1	Raised reflective markers is at least equal to the reference condition for ineffectiveness in any 10 consecutive markers (on a location-specific basis) in the BECR. (Ineffective includes missing, damaged, settled or sunk).	100%
	4.3	Delineators and markers	Object markers, mail box markers and delineators are: <ul style="list-style-type: none"> <li>• clean and visible</li> <li>• of the correct color and type</li> <li>• legible and reflective</li> <li>• straight and vertical</li> </ul>	24 hours	28 days	28 days	Visual inspection	4.3.1	The general condition is at least equal to the reference condition (on a location-specific basis) in the BECR.	100%
<b>5) CURBS, GUARDRAILS, SAFETY BARRIERS AND IMPACT ATTENUATORS</b>										
	5.1	Curbs	Curbs are free of cracks, chips and separation and are in proper grade and alignment.	24 hours	28 days	28 days	Visual inspection	5.1.1	The general condition is at least equal to the reference condition (on a location-specific basis) in the BECR.	100%
	5.2	Guardrails and safety barriers	All guardrails, safety barriers, and concrete barriers are maintained free of defects. They are appropriately placed and correctly installed at the correct height and distance from roadway or obstacles.	24 hours	28 days	28 days	Visual inspection	5.2.1	The general condition is at least equal to the reference condition (on a location-specific basis) in the BECR.	100%
	5.3	Impact attenuators	All impact attenuators are appropriately placed, correctly installed, and free of damage.	Not used	Not used	Not used	Not used	5.3.1	Not used	Not used
<b>6) TRAFFIC SIGNS</b>										
	6.1	General – All signs	(i) Signs are clean, correctly located, clearly visible, legible, reflective measured using TMUTCD criteria, at the correct height and free from structural and electrical defects. (ii) Identification markers are provided, correctly located, visible, clean and legible. (iii) Sign mounting posts are vertical, structurally sound and rust free. (iv) All break-away sign mounts are clear of silt or other debris that could impede break-away features and shall have correct stub heights. (v) Obsolete and redundant signs are removed or replaced as appropriate. (vi) Visibility distances meet the stated requirements. (vii) Sign information is of the correct size, location, type and wording to meet its intended purpose and any statutory requirements. (viii) All structures and elements of the signing system are kept clean and free from debris and have clear access provided. (ix) All replacement and repair materials and equipment are in accordance with the requirements of the TMUTCD.	24 hours	28 days	28 days	Visual inspection	6.1.1	The general condition is at least equal to the reference condition (on a location-specific basis) in the BECR.	100%
	6.2	Warning and regulatory signs	Requirements as 6.1, plus: Warning and regulatory signs are clean, legible and undamaged.	2 hours	24 hours	N/A	Visual inspection	6.2.1	The general condition is at least equal to the reference condition (on a location-specific basis) in the BECR.	100%

ATTACHMENT 19-1: PERFORMANCE AND MEASUREMENT TABLE

ELEMENT CATEGORY	REF	ELEMENT	PERFORMANCE OBJECTIVE	DEFECT REMEDY PERIOD			INSPECTION AND MEASUREMENT METHOD	REF	MEASUREMENT RECORD	TARGET
				Cat 1	Cat 1	Cat 2				
				Hazard Mitigation	Permanent Remedy	Permanent Repair				
<b>7) TRAFFIC SIGNALS</b>										
	7.1	General	(i) Traffic signals and their associated equipment shall be: <ul style="list-style-type: none"> <li>• clean and visible</li> <li>• correctly aligned and operational</li> <li>• free from damage caused by accident or vandalism</li> <li>• bulbs are not burned out</li> </ul> (ii) Signal timing and operation is correct. (iii) Comply with National Electric Code regulations. (iv) Traffic signals are structurally sound. (v) Signals have identification markers and the telephone number for reporting faults are correctly located, clearly visible, clean and legible. (vi) Contingency plans are in place to rectify Category 1 Defects not immediately repairable to assure alternative traffic control is provided during a period of failure.	Not used	Not used	Not used	Not used	7.1.1	Not used	Not used
	7.2	Pedestrian elements and vehicle detectors	All pedestrian elements and vehicle detectors are correctly positioned and fully functional.	Not used	Not used	Not used	Not used	7.2.1	Not used	Not used
<b>8) LIGHTING</b>										
	8.1	Roadway lighting – General	i) All lighting is free from defects and provides acceptable uniform lighting quality. ii) Lanterns are clean, clearly visible and correctly positioned. iii) Lighting units are free from accidental damage or vandalism. iv) Columns are upright, correctly founded, visually acceptable and structurally sound.	Not used	Not used	Not used	Not used	8.1.1	Not used	Not used
	8.2	Sign lighting	Sign lighting is fully operational.	Not used	Not used	Not used	Not used	8.2.1	Not used	Not used
	8.3	Aesthetic lighting	Aesthetic lighting is fully operational.	Not used	Not used	Not used	Not used	8.3.1	Not used	Not used
	8.4	Electrical supply	Electricity supply, feeder pillars, cabinets, switches and fittings are electrically, mechanically and structurally sound and functioning.	Not used	Not used	Not used	Not used	8.4.1	Not used	Not used
	8.5	Access panels	All access panels in place and secure at all times.	Not used	Not used	Not used	Not used	8.5.1	Not used	Not used
	8.6	High-mast lighting	(i) All high-mast luminaires functioning on each pole. (ii) All obstruction lights are present and working (if required). (iii) Compartment door is secure with all bolts in place. (iv) All winch and safety equipment are correctly functioning and maintained without rusting or corrosion. (for structural requirements refer to Element Category 3)	Not used	Not used	Not used	Not used	8.6.1	Not used	Not used

**ATTACHMENT 19-1: PERFORMANCE AND MEASUREMENT TABLE**

ELEMENT CATEGORY	REF	ELEMENT	PERFORMANCE OBJECTIVE	DEFECT REMEDY PERIOD			INSPECTION AND MEASUREMENT METHOD	REF	MEASUREMENT RECORD	TARGET
				Cat 1	Cat 1	Cat 2				
				Hazard Mitigation	Permanent Remedy	Permanent Repair				
<b>9) FENCES, WALLS AND SOUND ABATEMENT</b>										
	9.1	General	Integrity and structural condition of fences, walls and/or sound abatement elements are maintained and are free of: <ul style="list-style-type: none"> <li>• blocked weep holes</li> <li>• undesirable vegetation</li> <li>• defects in joint sealants</li> <li>• defects in pedestrian protection</li> <li>• scour damage</li> <li>• corrosion of rebar</li> <li>• paint system failure</li> <li>• concrete spalling</li> <li>• impact damage</li> </ul>	Not used	Not used	Not used	Not used	9.1.1	Not used	Not used
<b>10) ROADSIDE MANAGEMENT</b>										
	10.1	Vegetated areas – Except landscaped areas – General	Vegetation is maintained so that: <ul style="list-style-type: none"> <li>(i) Height of grass and weeds is kept within the limits described for rural or urban areas. Mowing begins before vegetation reaches the maximum height.</li> <li>(ii) Spot mowing at intersections, ramps or other areas maintains visibility of appurtenances and sight distance.</li> <li>(iii) Grass or vegetation does not encroach into or on paved shoulders, mainlanes, sidewalks, islands, riprap, traffic barrier or curbs.</li> <li>(iv) A herbicide program is undertaken in accordance with the TxDOT Roadside Vegetation Manual and the TxDOT Herbicide Operations Manual to control noxious weeds and to eliminate grass in pavement or concrete.</li> <li>(v) A full width mowing cycle is completed after the first frost.</li> <li>(vi) Wildflowers are preserved utilizing the guidelines in the mowing specifications and TxDOT Roadside Vegetation Management Manual.</li> </ul>	24 hours	7 days	28 days	Physical measurement	10.1.1	Urban Areas - Individual measurement areas have 95% of height of grass and weeds between 5" and 18".  Rural areas - Individual measurement areas have 95% of height of grass and weeds between 5" and 30".	100%
							Visual inspection	10.1.2	Other performance objectives met.	100%
	10.2	Landscaped areas	Mowing, litter pickup, irrigation system maintenance and operation, plant maintenance, pruning, insect, disease and pest control, fertilization, mulching, bed maintenance, watering is undertaken as per Maintenance Management Plan.	24 hours	7 days	28 days	Visual inspection	10.2.1	Performance objective met.	100%
	10.3	Fire hazards	Fire hazards are controlled.	24 hours	7 days	28 days	Visual inspection	10.3.1	Performance objective met.	100%
	10.4	Trees, brush and ornamentals	<ul style="list-style-type: none"> <li>(i) Trees, brush and ornamentals on the right of way, except in established no mow areas, are trimmed in accordance with TxDOT standards.</li> <li>(ii) Trees, brush and ornamentals are trimmed to insure they do not interfere with vehicles or sight distance, or inhibit the visibility of signs.</li> <li>(iii) Dead trees, brush, ornamentals and branches are removed. Potentially dangerous trees or limbs are removed.</li> </ul>	24 hours	7 days	28 days	Visual inspection	10.4.1	Performance objective met.	100%
	10.5	Wetlands	Wetlands are managed in accordance with the permit requirements.	24 hours	7 days	28 days	Visual inspection and records of compliance	10.5.1	The general condition is at least equal to the reference condition (on a location-specific basis) in the BECR.	100%

**ATTACHMENT 19-1: PERFORMANCE AND MEASUREMENT TABLE**

ELEMENT CATEGORY	REF	ELEMENT	PERFORMANCE OBJECTIVE	DEFECT REMEDY PERIOD			INSPECTION AND MEASUREMENT METHOD	REF	MEASUREMENT RECORD	TARGET
				Cat 1	Cat 1	Cat 2				
				Hazard Mitigation	Permanent Remedy	Permanent Repair				
	10.6	Sidewalks and pedestrian curb ramps	Compliance with TxDOT Design Standards and Americans with Disabilities Act (ADA) requirements for construction and maintenance	24 hours	7 days	28 days	Visual inspection	10.6.1	The general condition is at least equal to the reference condition (on a location-specific basis) in the BECR.	100%
<b>11) REST AREAS AND PICNIC AREAS (NOT USED)</b>										
<b>12) EARTHWORKS, EMBANKMENTS AND CUTTINGS</b>										
	12.1	Slope failure	All structural or natural failures of the embankment and cut slopes of the Project are repaired.	24 hours	28 days	6 months	Visual inspection	12.1.1	The general condition is at least equal to the reference condition (on a location-specific basis) in the BECR.	100%
	12.2	Slopes - General	Slopes are maintained in general conformance to the original graded cross-sections, the replacement of landscaping materials, reseeding and re-vegetation for erosion control purposes and removal and disposal of all eroded materials from the roadway and shoulders.	24 hours	28 days	6 months	Visual inspection	12.2.1	The general condition is at least equal to the reference condition (on a location-specific basis) in the BECR.	100%
	12.3	Slopes – Erosion	Slopes are maintained to prevent erosion leading to further deterioration.	24 hours	28 days	3 months	Visual inspection	12.3.1	The general condition is at least equal to the reference condition (on a location-specific basis) in the BECR.	100%
	12.4	Slopes - Permanent Erosion Control Measures	Where permanent erosion control measures such as rock or concrete riprap are utilized: no undermined or damaged erosion control measures and keep concrete slope protection joints sealed and free from vegetation.	24 hours	28 days	3 months	Visual inspection	12.4.1	The general condition is at least equal to the reference condition (on a location-specific basis) in the BECR.	100%
<b>13) ITS EQUIPMENT</b>										
	13.1	ITS Equipment - Maintenance	All ITS equipment is fully functional and housing is functioning and free of defects. i) All equipment and cabinet identification numbers are visible, sites are well drained and access is clear. ii) Steps, handrails and accesses are kept in a good condition. iii) Access to all communication hubs, ground boxes, cabinets and sites is clear. iv) All drainage is operational and all external fixtures and fittings are in a satisfactory condition. v) All communications cable markers, cable joint markers and duct markers are visible and missing markers are replaced. vi) Backup power supply system is available at all times.	Not used	Not used	Not used	Not used	13.1.1	Not used	Not used
	13.2	Dynamic Message Sign Equipment	Dynamic Message Signs are free from faults such as: i) Any signal displaying a message which is deemed to be a safety hazard. ii) Failure of system to clear sign settings when appropriate. iii) 2 or more contiguous sign failures that prevent control office setting strategic diversions. iv) Signs displaying an incorrect message.	Not used	Not used	Not used	Not used	13.2.1	Not used	Not used

**ATTACHMENT 19-1: PERFORMANCE AND MEASUREMENT TABLE**

ELEMENT CATEGORY	REF	ELEMENT	PERFORMANCE OBJECTIVE	DEFECT REMEDY PERIOD			INSPECTION AND MEASUREMENT METHOD	REF	MEASUREMENT RECORD	TARGET
				Cat 1	Cat 1	Cat 2				
				Hazard Mitigation	Permanent Remedy	Permanent Repair				
	13.3	CCTV Equipment	CCTV Systems are free from serious faults that significantly limit the availability of the operators to monitor the area network, such as: i) Failure of CCTV Systems to provide control offices with access and control of CCTV images. ii) Failure of a CCTV camera or its video transmission system. iii) Failure of a Pan / Tilt unit or its control system. iv) Moisture ingress onto CCTV camera lens. v) Faults that result in significant degradation of CCTV images.	Not used	Not used	Not used	Not used	13.3.1	Not used	Not used
	13.4	Vehicle Detection Equipment	All equipment free of defects and operational problems such as: i) Inoperable loops ii) Malfunctioning camera controllers	Not used	Not used	Not used	Not used	13.4.1	Not used	Not used
<b>14) TOLLING FACILITIES AND BUILDINGS (NOT USED)</b>										
<b>15) AMENITY</b>										
	15.1	Graffiti	Graffiti is removed in a manner and using materials that restore the surface to a like appearance similar to adjoining surfaces (i) Category 1 Defect – Obscene, apparent gang-related, or highly visible graffiti (ii) Category 2 Defect – Graffiti other than Category 1 Defect	4 hours	7 days	N/A	Visual inspection	15.1.1	Graffiti is not present	100%
	15.2	Animals	All dead or injured animals are removed.	2 hours	N/A	N/A	Visual inspection	15.2.1	Dead or injured animals are not present.	100%
	15.3	Abandoned vehicles and equipment	Notify law enforcement of any abandoned vehicles and equipment for the removal from the Project ROW.	1 hour	3 days	N/A	Visual inspection	15.3.1	Abandoned vehicles or equipment are not present.	100%
<b>16) SNOW AND ICE CONTROL</b>										
	16.1	Travel lanes	Maintain travel way free from snow and ice.	2 hours	N/A	N/A	Records of all snow and ice controls	16.1.1	Response times are met for all snow and ice controls: (i) Maximum 1 hr response time to complete manning and loading of spreading vehicles (ii) Maximum 2 hrs from departure from loading point to complete treatment and return to loading point (iii) Maximum 1 hr response time for snow and ice clearance vehicles to depart from base	100%

**ATTACHMENT 19-1: PERFORMANCE AND MEASUREMENT TABLE**

ELEMENT CATEGORY	REF	ELEMENT	PERFORMANCE OBJECTIVE	DEFECT REMEDY PERIOD			INSPECTION AND MEASUREMENT METHOD	REF	MEASUREMENT RECORD	TARGET
				Cat 1	Cat 1	Cat 2				
				Hazard Mitigation	Permanent Remedy	Permanent Repair				
<b>17) INCIDENT RESPONSE</b>										
	17.1	General	(i) Monitor the Project and respond to Incidents in accordance with the Maintenance Management Plan (MMP). (ii) Monitor the Project and respond to Incidents involving Hazardous Materials in accordance with the Maintenance Management Plan. (iii) Evaluate structural damage to structures and liaise with emergency services to ensure safe working environment while clearing the Incident.	1 hour	N/A	N/A	Records of all incident and emergency responses	17.1.1	Response times are met for 98% of Incidents measured on a 1 year rolling basis and no complaints from Emergency Services.	100%
	17.2	Temporary and permanent remedy	(i) Propose and implement temporary measures or permanent remedies to Defects arising from the Incident. (ii) Ensure the structural safety of any structures affected by the Incident.	24 hours	28 days	N/A	Review and inspection of the Incident site	17.2.1	Performance objective met.	100%
<b>18) CUSTOMER RESPONSE</b>										
	18.1	Response to inquiries	Timely and effective response to customer inquiries and complaints: (i) Contact the customer within 48 hours following initial customer inquiry. (ii) All work resulting from customer requests is scheduled within 48 hours of customer contact. (iii) All customer concerns/requests are resolved to TxDOT's satisfaction within 2 weeks of the initial inquiry.	48 hours	14 days	N/A	Records of all customer inquires and responses	18.1.1	Performance objective met.	100%
	18.2	Customer Contact Line	Telephone line manned during business hours and 24 hour availability of messaging system. Faults to telephone line or message system rectified.	24 hours	7 days	N/A	Availability of the customer contact line	18.2.1	No instances of line out of action or unmanned.	100%
<b>19) SWEEPING AND CLEANING</b>										
	19.1	Obstructions and debris	Roadway and clear zone free from obstructions and debris including at a minimum objects, luminaire poles, and tires.	2 hours	N/A	N/A	Visual Inspection	19.1.1	No obstructions and debris on roadway and clear zone.	100%
	19.2	Sweeping	i) Keep all channels, hard shoulders, gore areas, ramps, intersections, islands and access roads swept clean. ii) Clear and remove debris from traffic lanes, hard shoulders, verges and central reservations, footways and cycle ways. iii) Remove all sweepings without stockpiling in the right of way and dispose of at approved tip.	24 hours	3 days	N/A	Visual Inspection	19.2.1	No buildup of dirt, ice, rock, debris, etc. on roadways and bridges to accumulate greater than 18" wide or 1/2" deep.	100%
	19.3	Litter	i) Keep the right of way in a neat condition, remove litter regularly. ii) Pick up large litter items before mowing operations. iii) Dispose of all litter and debris collected at an approved solid waste site.	24 hours	3 days	N/A	Visual Inspection	19.3.1	No more than 30 pieces of litter (rural) and 50 pieces of litter (urban) per roadside mile shall be visible when traveling at highway speed.	100%

**NOTES FOR PERFORMANCE AND MEASUREMENT TABLE**

1. "Cat 1 Hazard Mitigation" shall be an action taken by DB Contractor to mitigate a hazard to Users or imminent risk of damage or deterioration to property or the environment.
2. "Cat 1 Permanent Remedy" shall be an action taken by DB Contractor to restore the condition of an Maintenance Element following "Cat 1 Hazard Mitigation" of a Category 1 Defect: (a) to the standard required for new construction; or (b) to a condition such that the Target is achieved for each "Measurement Record".
3. "Cat 2 Permanent Repair" shall be an action taken by DB Contractor to restore the condition of an Maintenance Element for which a Category 2 Defect has been recorded: (a) to the standard required for new construction; or (b) to a condition such that the Target is achieved for each "Measurement Record".

Texas Department of Transportation  
Technical Provisions  
for  
SH 249 Extension

Attachment 19-2  
Baseline Inspection Requirements

February 9, 2017

**ATTACHMENT 19-2: BASELINE INSPECTION REQUIREMENTS**

Provide photographic records and physical measurements referenced by location to establish an agreed reference condition for each Performance Section as follows:				
ELEMENT CATEGORY	ELEMENT	INSPECTION/MEASUREMENT METHOD	MEASUREMENT REF*	MEASUREMENT RECORD
<b>1) PAVEMENT</b>				
1.1	Ruts	Physical measurement	1.1.1	Percentage of wheel path length with ruts greater than ¼" in depth in each Performance Section if length exceeds, - 3% for Mainlanes, shoulders, cross-streets and ramps - 10% for access roads in each Performance Section
		Physical measurement	1.1.2	Location and depth of any individual rut that is greater than 1/2".
1.2	Ride quality	10-ft straight edge used to measure discontinuities	1.2.1	Location and depth of any individual discontinuity (e.g. bumps and depressions) that is greater than 3/4".
1.3	Cracking	Physical measurement	1.3.1	Location and width of any unsealed longitudinal cracking and/or transverse cracking with a width greater than 1/4".
1.7	Edge drop-offs	Physical measurement	1.7.1	Location and depth of any individual edge drop-off that is greater than 2".
1.9	Joints in concrete	Physical measurement	1.9.1	Not used
			1.9.2	Not used
<b>2) DRAINAGE</b>				
2.1	Pipes, ditches, channels, catch basins, inlets, manholes and outfalls	Visual Inspection	2.1.1	General condition
2.2	Drainage treatment devices	Visual Inspection	2.2.1	General condition
2.6	Erosion	Visual inspection	2.6.1	Location and general condition of any erosion greater than 12" deep along ditches, swales, ponds, and channels.
2.7	Channels and ditches - Permanent erosion control measures	Visual inspection	2.7.1	Location and general condition of any undermined or damaged erosion control measures.
<b>3) STRUCTURES (NOT USED)</b>				
<b>4) PAVEMENT MARKINGS, OBJECT MARKERS, BARRIER MARKERS AND DELINEATORS</b>				
4.1	Pavement markings	a) Markings - General Visual inspection (to include a record of visibility of markings under low beam headlights.)	4.1.1	Marking visibility under low-beam headlight.
		Physical measurement	4.1.2	Location and length of pavement marking where there is loss of material.
		b) Profile markings - visual inspection	4.1.3	General condition
4.2	Raised reflective markers	Visual inspection	4.2.1	Location and number of raised reflective markers that are ineffective in any 10 consecutive markers. (Ineffective includes missing, damaged, settled or sunk).
4.3	Delineators and markers	Visual inspection	4.3.1	General condition
<b>5) CURBS, GUARDRAILS, SAFETY BARRIERS AND IMPACT ATTENUATORS</b>				
5.1	Curbs	Visual inspection	5.1.1	General condition
5.2	Guardrails and safety barriers	Visual inspection	5.2.1	General condition
5.3	Impact attenuators	Visual inspection	5.3.1	Not used
<b>6) TRAFFIC SIGNS</b>				
6.1	General – All signs	Visual inspection	6.1.1	General condition
6.2	Warning and regulatory signs	Visual inspection	6.2.1	General condition
<b>7) TRAFFIC SIGNALS (NOT USED)</b>				
<b>8) LIGHTING (NOT USED)</b>				
<b>9) FENCES, WALLS AND SOUND ABATEMENT (NOT USED)</b>				
<b>10) ROADSIDE MANAGEMENT</b>				
10.5	Wetlands	Visual inspection and records of compliance	10.5.1	General condition
10.6	Sidewalks and pedestrian curb ramps	Visual inspection	10.6.1	General condition
<b>12) EARTHWORKS, EMBANKMENTS AND CUTTINGS</b>				
12.1	Slope failure	Visual inspection	12.1.1	Location and severity of any slope failure
12.2	Slopes – General	Visual inspection	12.2.1	General condition
12.3	Slopes – Erosion	Visual inspection	12.3.1	Location and depth of any erosion greater than 6" deep
12.4	Slopes – Permanent Erosion Control Measures	Visual inspection	12.4.1	Location and general condition of any undermined or damaged erosion control measures
<b>13) ITS EQUIPMENT (NOT USED)</b>				

Notes

\* Measurement ref to be cross-referenced with Attachment 19-1.



Texas Department of Transportation  
Technical Provisions  
for  
SH 249 Extension

Attachment 19-3  
Maintenance Limits

February 9, 2017

Scale: \$SCALE\$  
 Plotted on: \$DATE\$ 4:04:37 PM

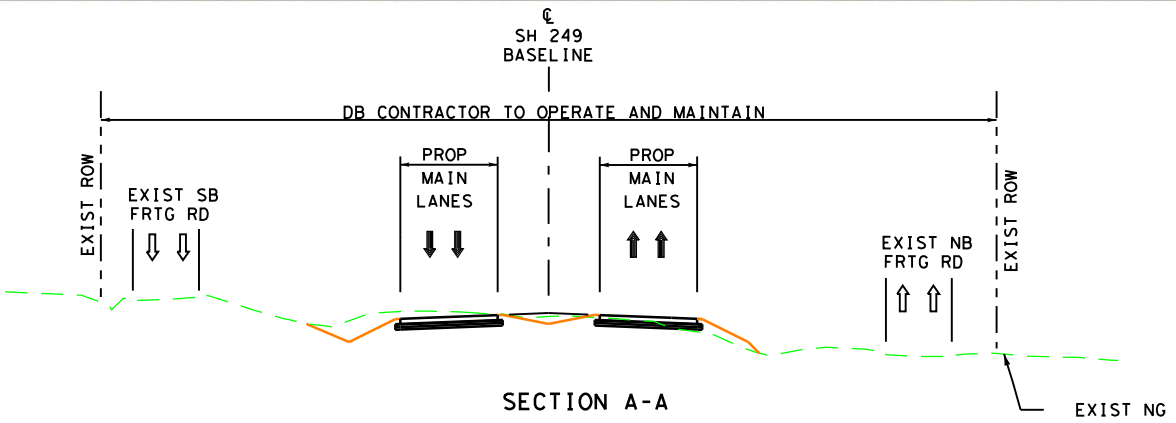
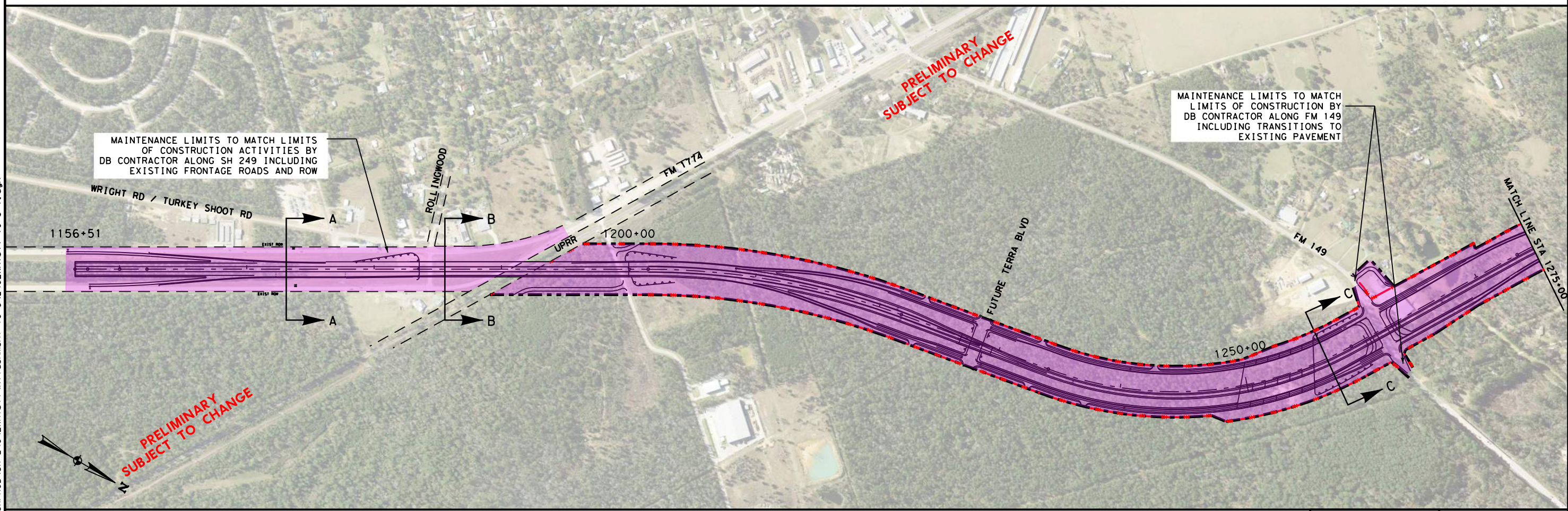
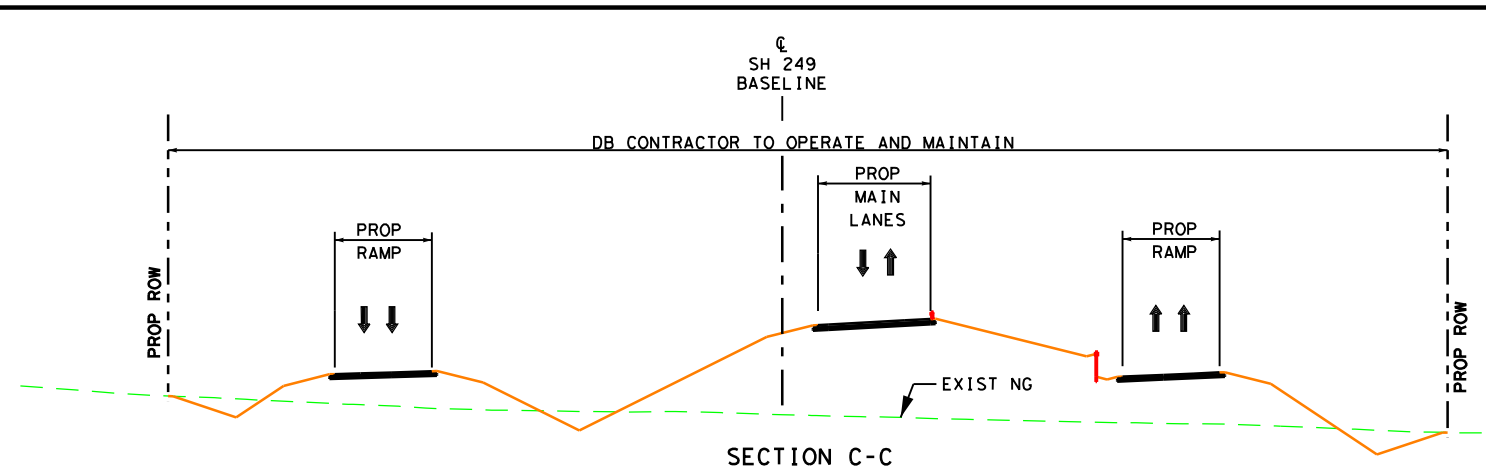
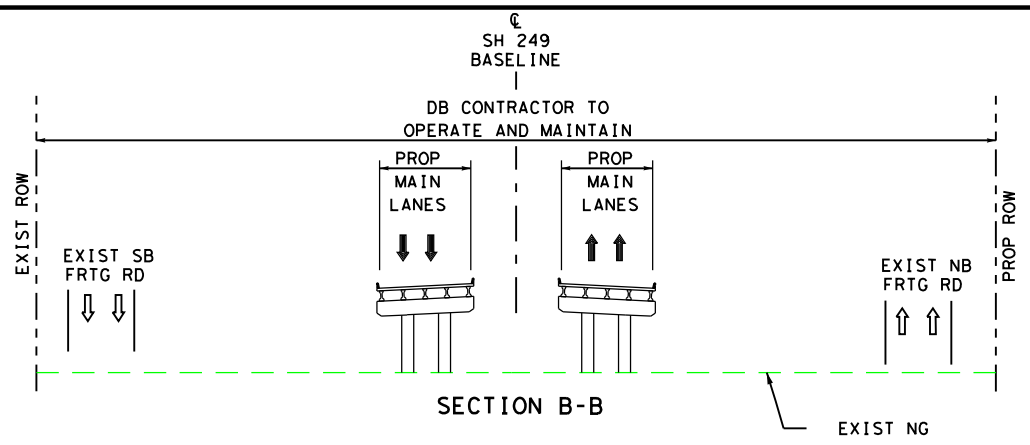

- LEGEND**
- LIMITS OF DB CONTRACTOR'S CONSTRUCTION, OPERATIONS, AND MAINTENANCE RESPONSIBILITIES
  - PROPOSED SH 249
  - PROP ROW
  - PROP CONTROL OF ACCESS
  - PROPOSED DETENTION POND
  - EXISTING ROW

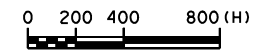

**ATTACHMENT 19-3  
 MAINTENANCE LIMITS  
 SEGMENTS 1 & 2**

DSN:	FED. RD. DIV. NO.	STATE	PROJECT NO.	HIGHWAY NO.
CK:		TEXAS		SH249
DRN:	STATE DISTRICT	COUNTY	CONTROL NO.	SECTION NO.
CK:				JOB NO.
				SHEET NO.
				1

\$USER\$ Pen Tablet: \$PEN\$ Design File name: \\hoxw00\jobs\59004\TECHPROD\SH 249\Exhibit\Attachment 19-3\249Exhibit\19-3-1.dgn

Design File name: \\hoxw00\jobs\59004\TECHPROD\SH 249\Exhibit\Attachment 19-3\249Exhibit\19-3-1.dgn

Scale: \$SCALE\$  
 Plotted on: \$DATE\$ 3:49:56 PM

\$USER\$  
 Pen Table: \$PEN\$  
 Design File Name: \\hoxw00\jobs\59004\TECHPROD\SH 249\Exhibit\Attachment 19-3\249Exhibit\19-3\*2.dgn

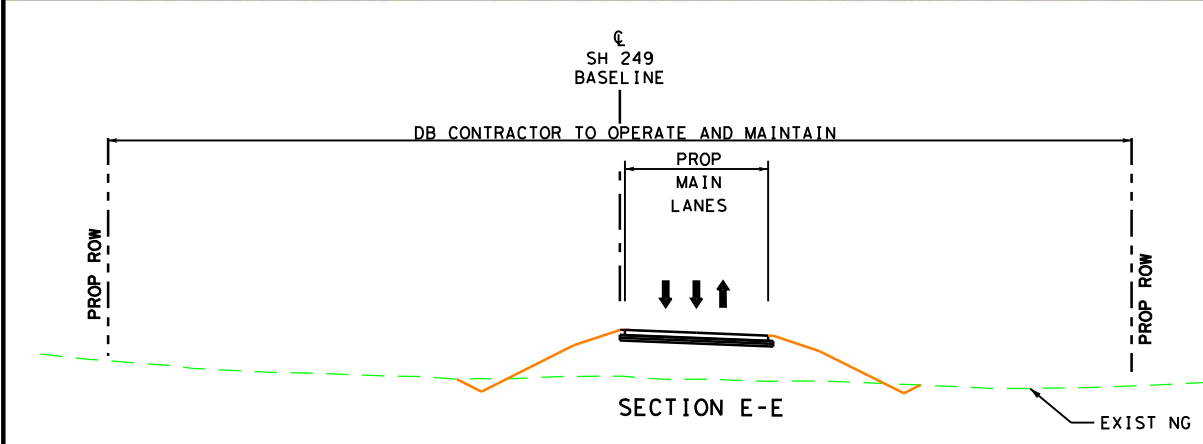
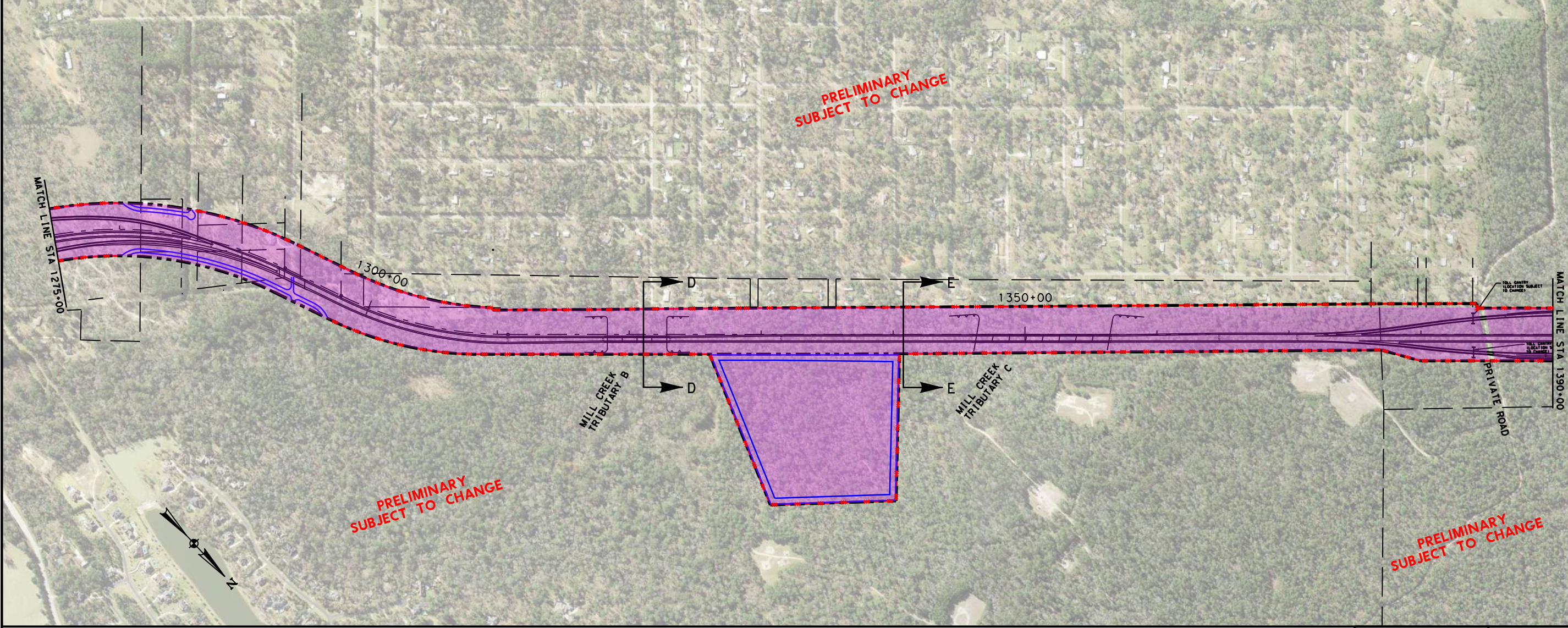
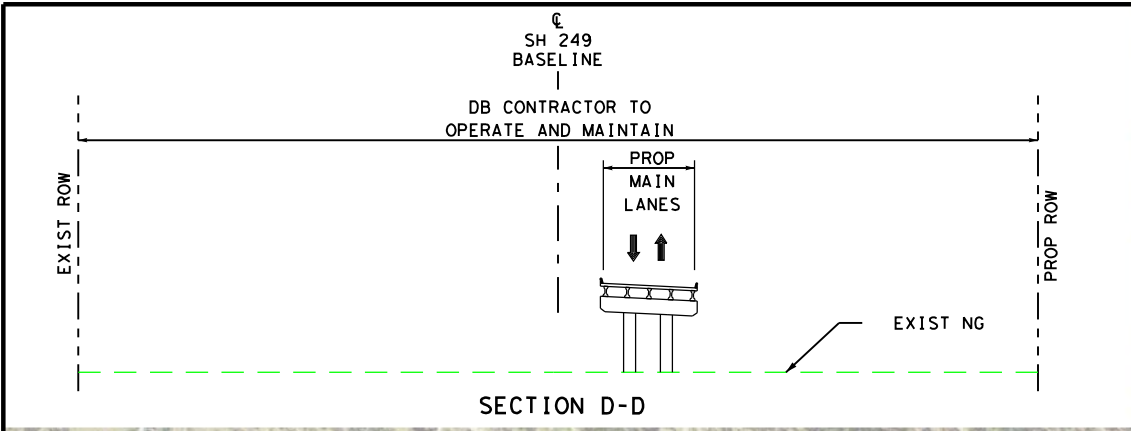

- LEGEND**
- LIMITS OF DB CONTRACTOR'S CONSTRUCTION, OPERATIONS, AND MAINTENANCE RESPONSIBILITIES
  - PROPOSED SH 249
  - PROP ROW
  - PROP CONTROL OF ACCESS
  - PROPOSED DETENTION POND
  - EXISTING ROW

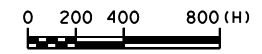

**ATTACHMENT 19-3  
 MAINTENANCE LIMITS  
 SEGMENTS 1 & 2**

DSN#:	FED. RD. DIV. NO.:	STATE:	PROJECT NO.:	HIGHWAY NO.:
CK#:		TEXAS		SH249
DRN#:	STATE DISTRICT:	COUNTY:	CONTROL NO.:	SECTION NO.:
CK#:				
				JOB NO.:
				SHEET NO.:
				2

Design File Name: \\hoxw00\jobs\59004\TECHPROD\SH 249\Exhibit\Attachment 19-3\249Exhibit\19-3\*2.dgn

Scale: \$SCALE\$  
 Plotted on: \$DATE\$ 3:51:27 PM

\$USER\$  
 Pen Table: \$PEN\$  
 Design File Name: \\hoxw00\jobs\59004\TECHPROD\SH 249\Exhibit\Attachment 19-3\249Exhibit\19-3-3.dgn

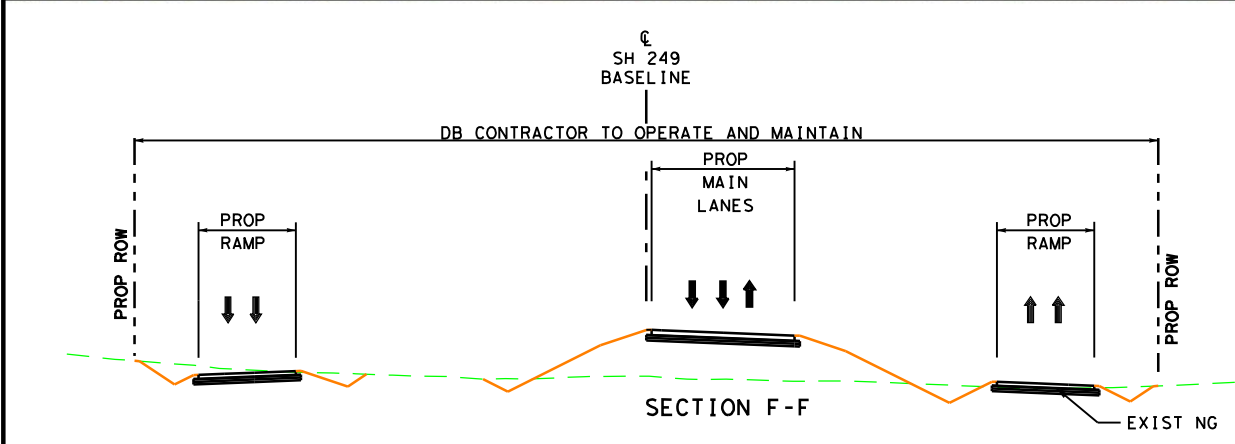
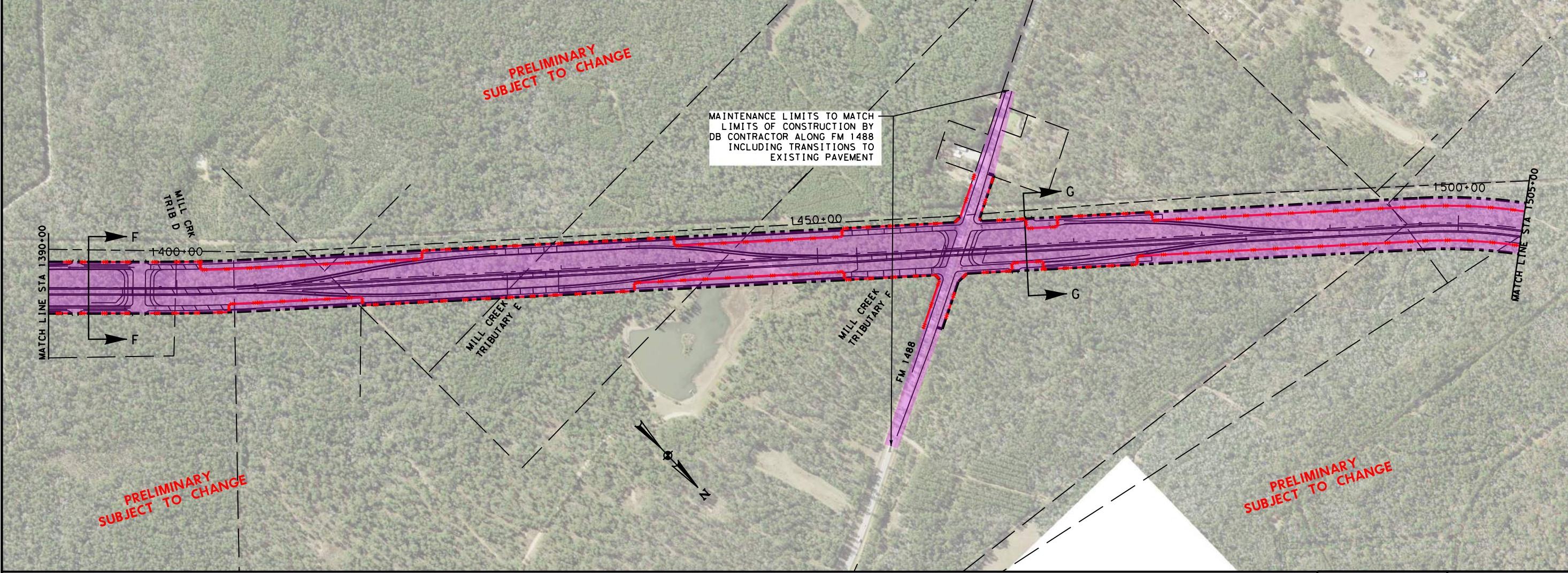
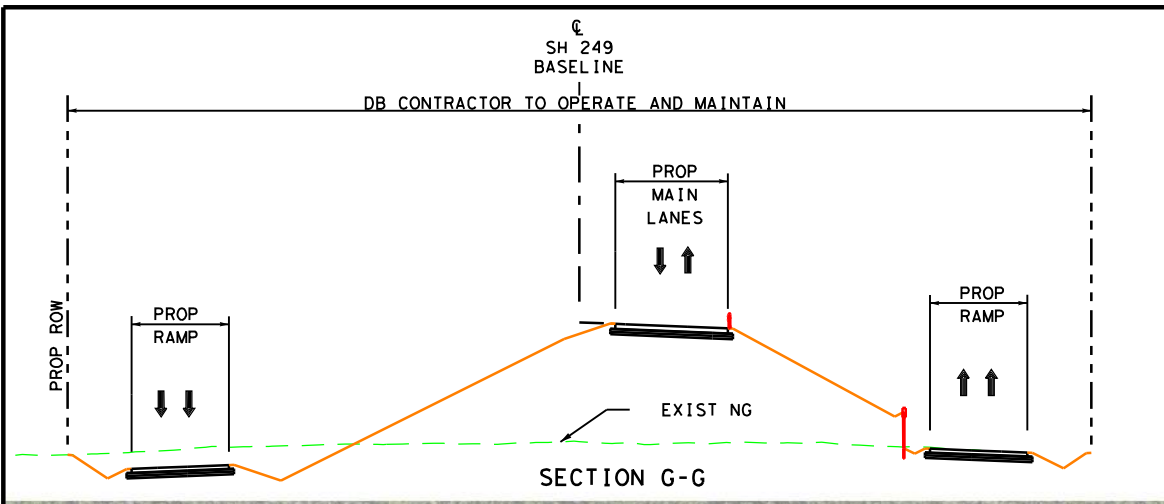

- LEGEND**
- LIMITS OF DB CONTRACTOR'S CONSTRUCTION, OPERATIONS, AND MAINTENANCE RESPONSIBILITIES
  - PROPOSED SH 249
  - PROP ROW
  - PROP CONTROL OF ACCESS
  - PROPOSED DETENTION POND
  - EXISTING ROW

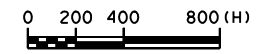

**ATTACHMENT 19-3  
 MAINTENANCE LIMITS  
 SEGMENTS 1 & 2**

DSN:	FED. RD. DIV. NO.	STATE	PROJECT NO.	HIGHWAY NO.
CK:		TEXAS		SH249
DRN:	STATE DISTRICT	COUNTY	CONTROL NO.	SECTION NO.
CK:				
				JOB NO.
				3

Design File Name: \\hoxw00\jobs\59004\TECHPROD\SH 249\Exhibit\Attachment 19-3\249Exhibit\19-3-3.dgn

Scale: \$SCALE\$  
 Plotted on: \$DATE\$ 3:52:47 PM

\$USER\$  
 Pen Table: \$PEN\$  
 Design File Name: \\hoxw00\jobs\59004\TECHPROD\SH 249\Exhibit\Attachment 19-3\249Exhibit\19-3\*4.dgn

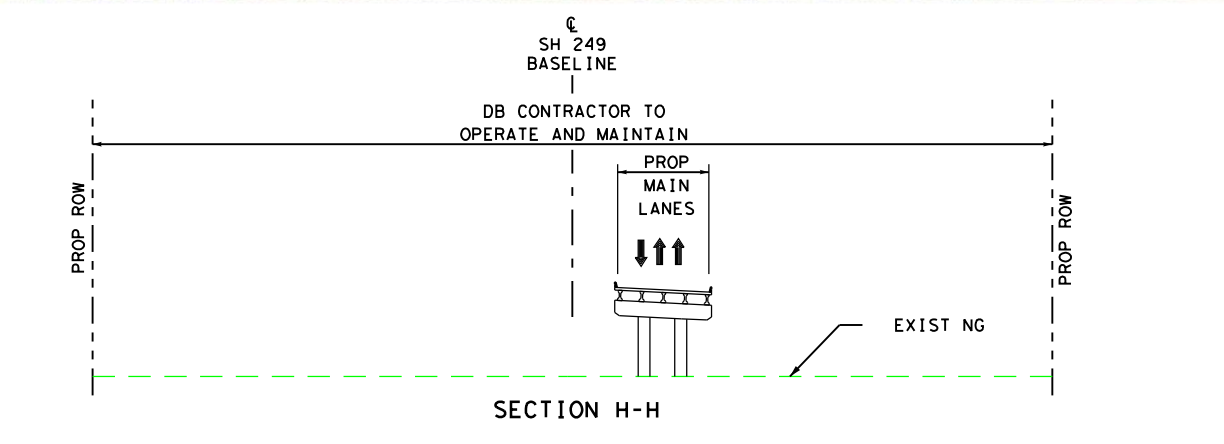
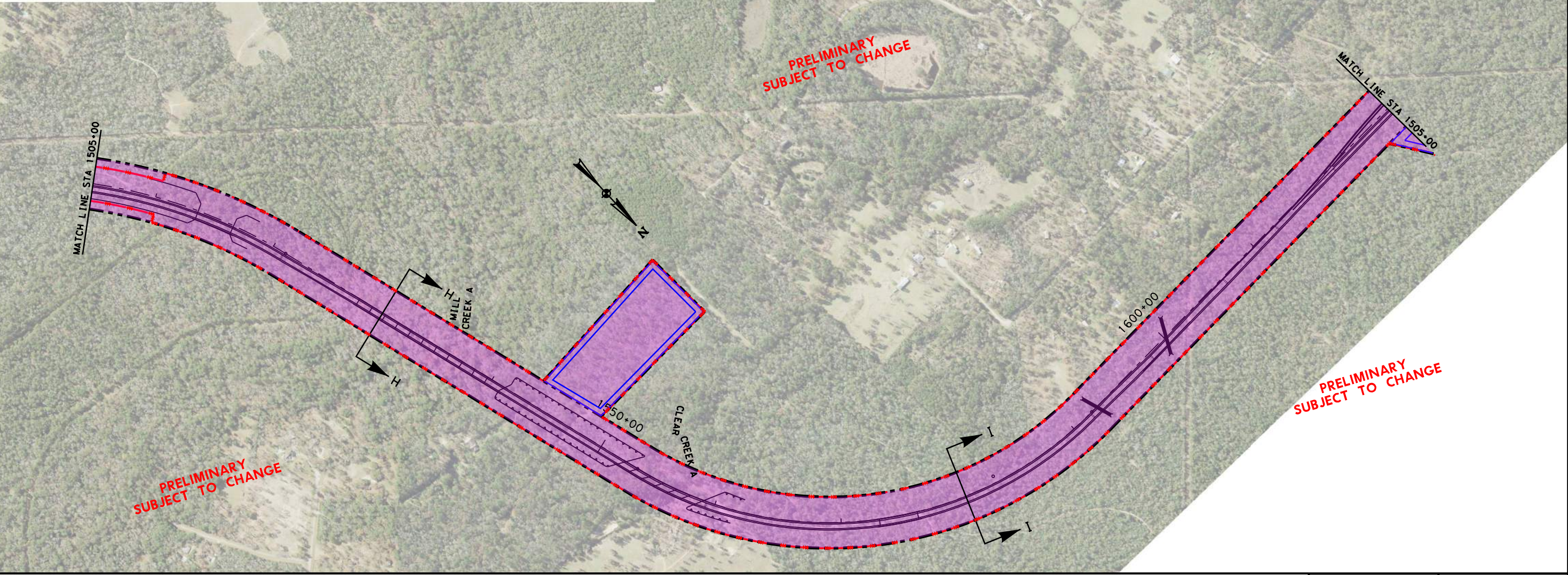
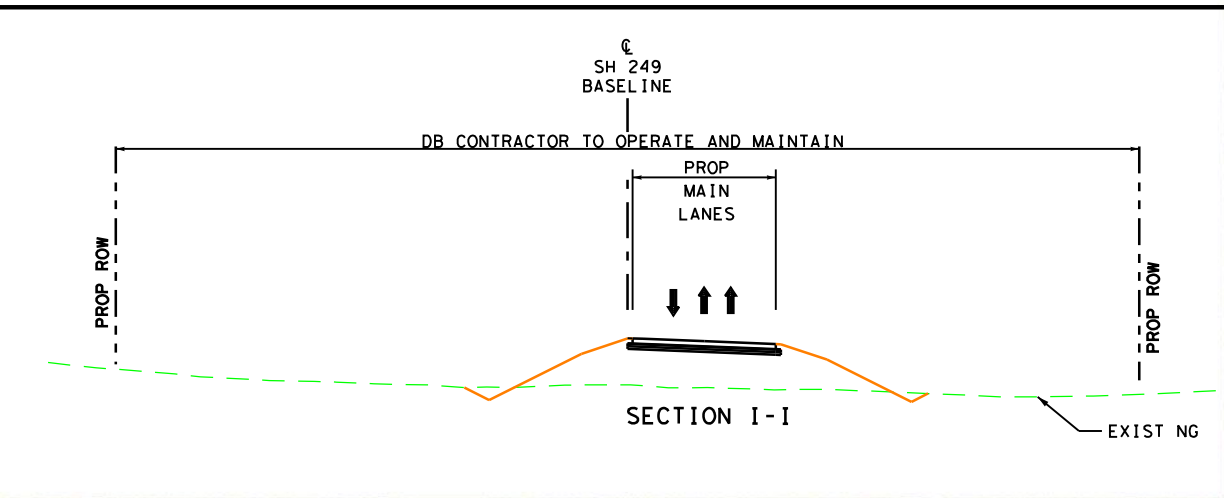

- LEGEND**
- LIMITS OF DB CONTRACTOR'S CONSTRUCTION, OPERATIONS, AND MAINTENANCE RESPONSIBILITIES
  - PROPOSED SH 249
  - PROP ROW
  - PROP CONTROL OF ACCESS
  - PROPOSED DETENTION POND
  - EXISTING ROW

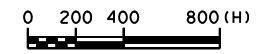

**ATTACHMENT 19-3  
 MAINTENANCE LIMITS  
 SEGMENTS 1 & 2**

DSN:	FED. RD. DIV. NO.	STATE	PROJECT NO.	HIGHWAY NO.
CK:		TEXAS		SH249
DRN:	STATE DISTRICT	COUNTY	CONTROL NO.	SECTION NO.
CK:				JOB NO. SHEET NO.
				4

Design File Name: \\hoxw00\jobs\59004\TECHPROD\SH 249\Exhibit\Attachment 19-3\249Exhibit\19-3\*4.dgn

Scale: \$SCALE\$  
 Plotted on: \$DATE\$ 3:54:12 PM

\$USER\$  
 Pen Table: \$PEN\$  
 Design File Name: \\hoxw00\jobs\59004\TECHPROD\SH 249\Exhibit\Attachment 19-3\249Exhibit\19-3\*5.dgn

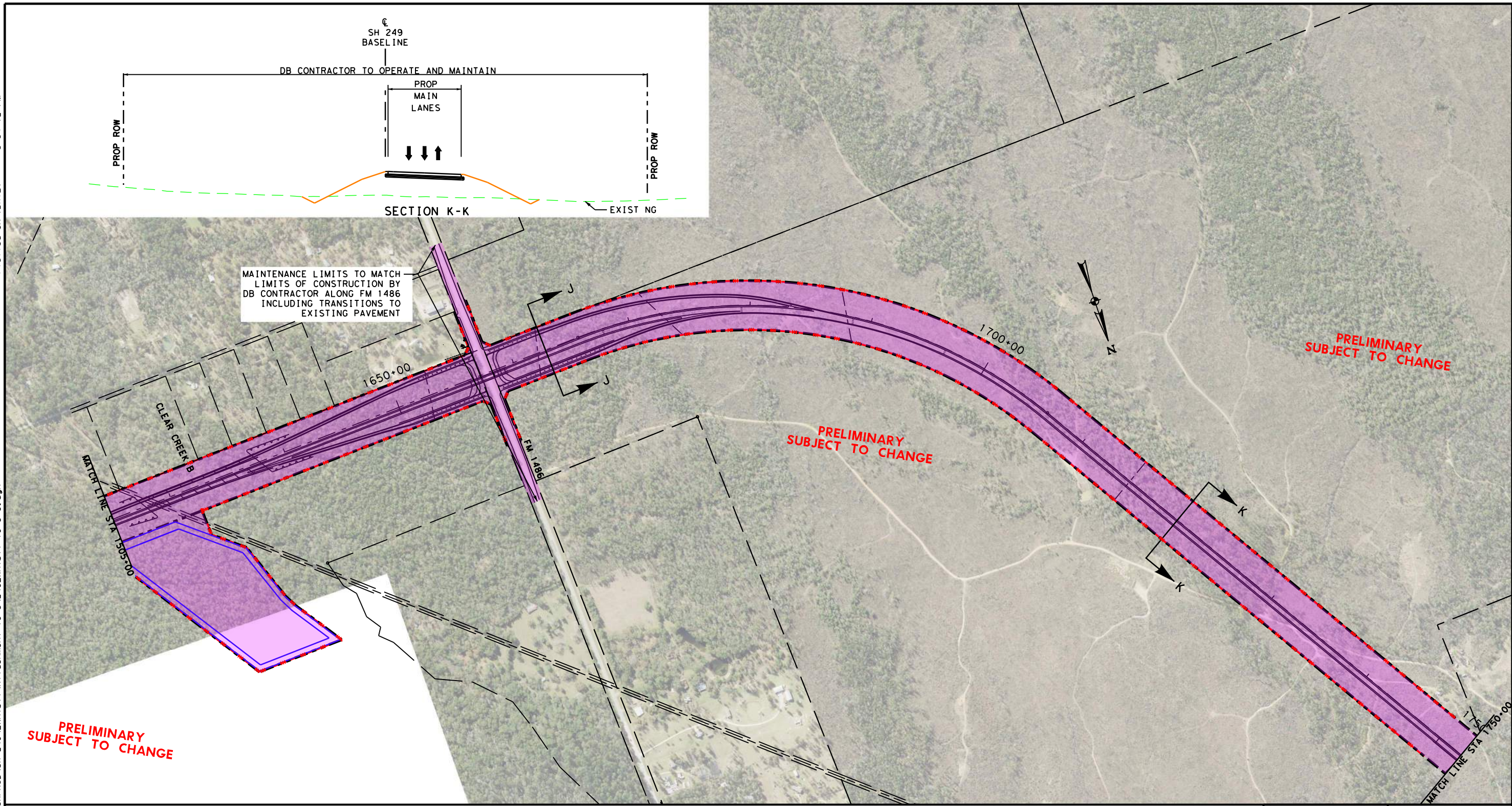

MAINTENANCE LIMITS TO MATCH LIMITS OF CONSTRUCTION BY DB CONTRACTOR ALONG FM 1486 INCLUDING TRANSITIONS TO EXISTING PAVEMENT

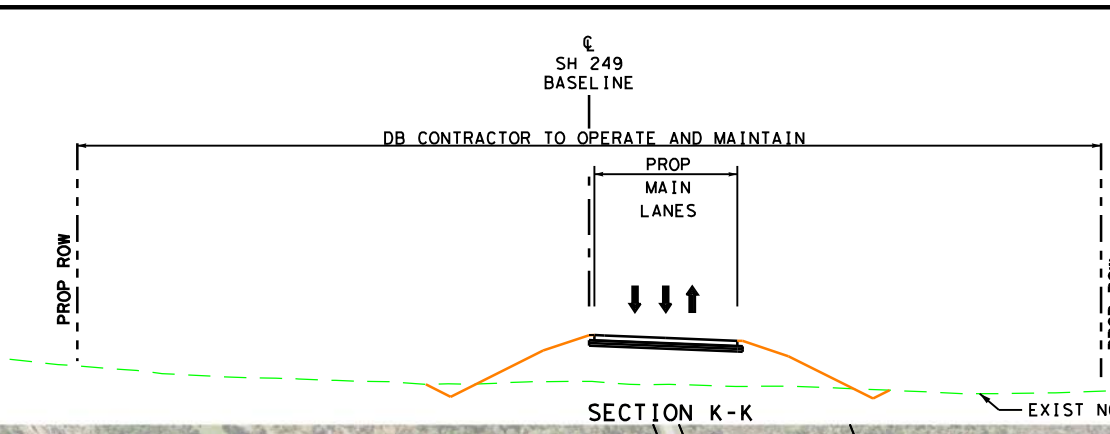
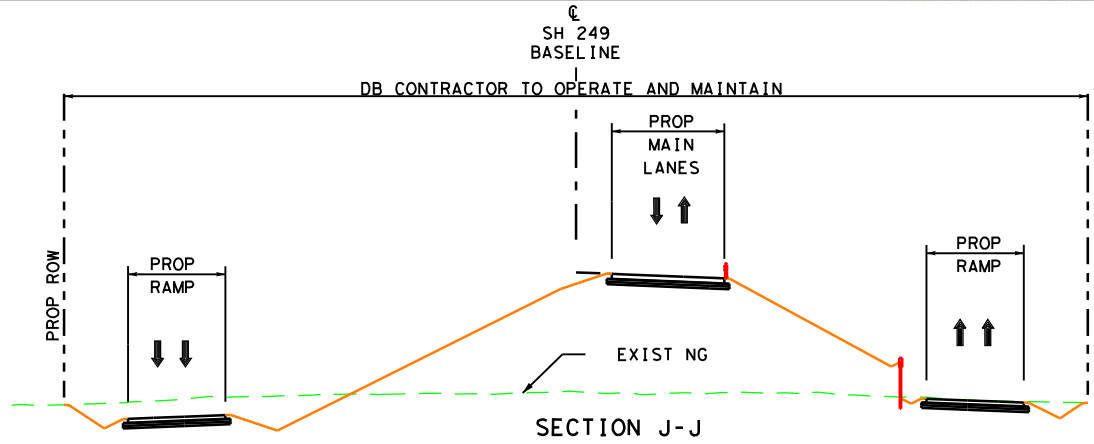

- LEGEND**
- LIMITS OF DB CONTRACTOR'S CONSTRUCTION, OPERATIONS, AND MAINTENANCE RESPONSIBILITIES
  - PROPOSED SH 249
  - PROP ROW
  - PROP CONTROL OF ACCESS
  - PROPOSED DETENTION POND
  - EXISTING ROW

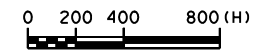

**ATTACHMENT 19-3  
 MAINTENANCE LIMITS  
 SEGMENTS 1 & 2**

DSN:	FED. RD. DIV. NO.	STATE	PROJECT NO.	HIGHWAY NO.
CK:		TEXAS		SH249
DRN:	STATE DISTRICT	COUNTY	CONTROL NO.	SECTION NO.
CK:				JOB NO.
				SHEET NO.
				5

Design File Name: \\hoxw00\jobs\59004\TECHPROD\SH 249\Exhibit\Attachment 19-3\249Exhibit\19-3\*5.dgn

Scale: \$SCALE\$  
 Plotted on: \$DATE\$ 3:55:37 PM

\$USER\$  
 Pen Table: \$PEN\$  
 Design File Name: \\hoxw00\jobs\59004\TECHPROD\SH 249\Exhibit\Attachment 19-3\249Exhibit\19-3\*6.dgn

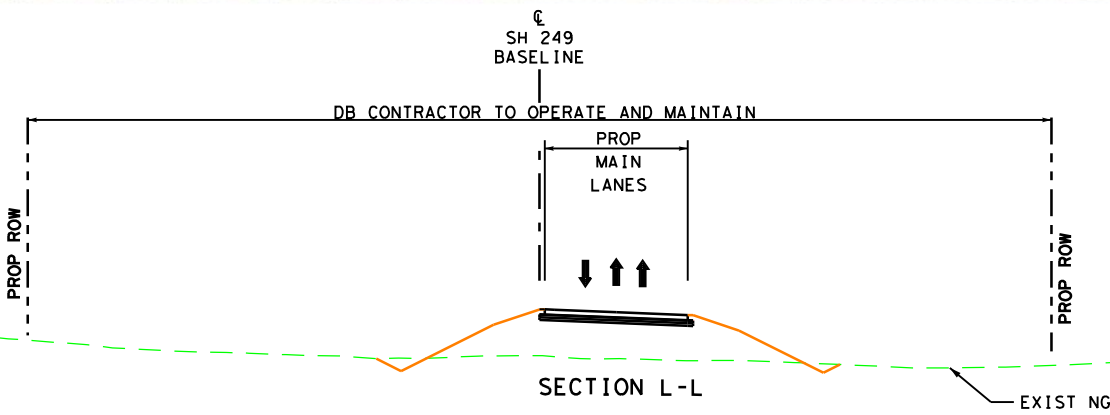
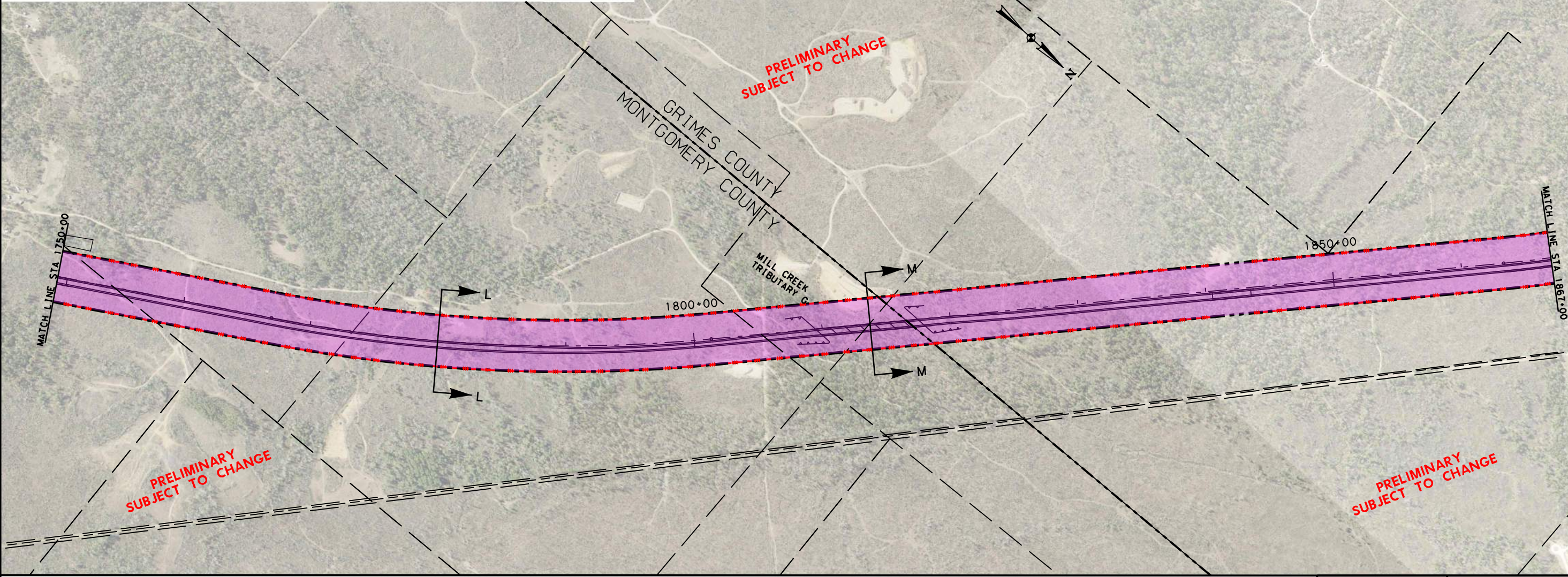
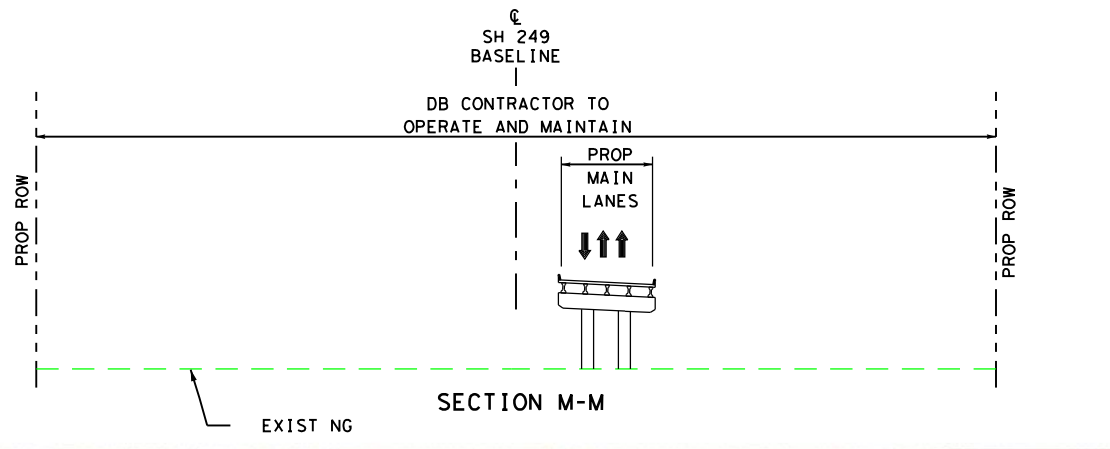

- LEGEND**
- LIMITS OF DB CONTRACTOR'S CONSTRUCTION, OPERATIONS, AND MAINTENANCE RESPONSIBILITIES
  - PROPOSED SH 249
  - PROP ROW
  - PROP CONTROL OF ACCESS
  - PROPOSED DETENTION POND
  - EXISTING ROW

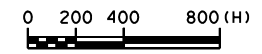

**ATTACHMENT 19-3  
 MAINTENANCE LIMITS  
 SEGMENTS 1 & 2**

DSN:	FED. RD. DIV. NO.	STATE	PROJECT NO.	HIGHWAY NO.
CK:		TEXAS		SH249
DRN:	STATE DISTRICT	COUNTY	CONTROL NO.	SECTION NO.
CK:				
				JOB NO.
				SHEET NO.
				6

Design File Name: \\hoxw00\jobs\59004\TECHPROD\SH 249\Exhibit\Attachment 19-3\249Exhibit\19-3\*6.dgn

Scale: \$SCALE\$  
 Plotted on: \$DATE\$ 3:57:37 PM

\$USER\$  
 Pen Table: \$PEN\$  
 Design File Name: \\hoxw00\jobs\59004\TECHPROD\SH 249\Exhibit\Attachment 19-3\249Exhibit\19-3\*7.dgn

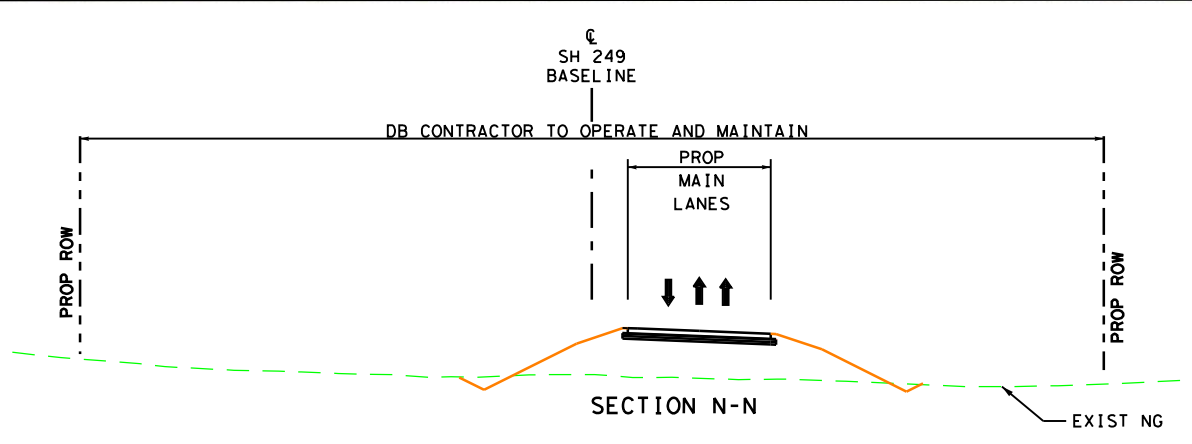
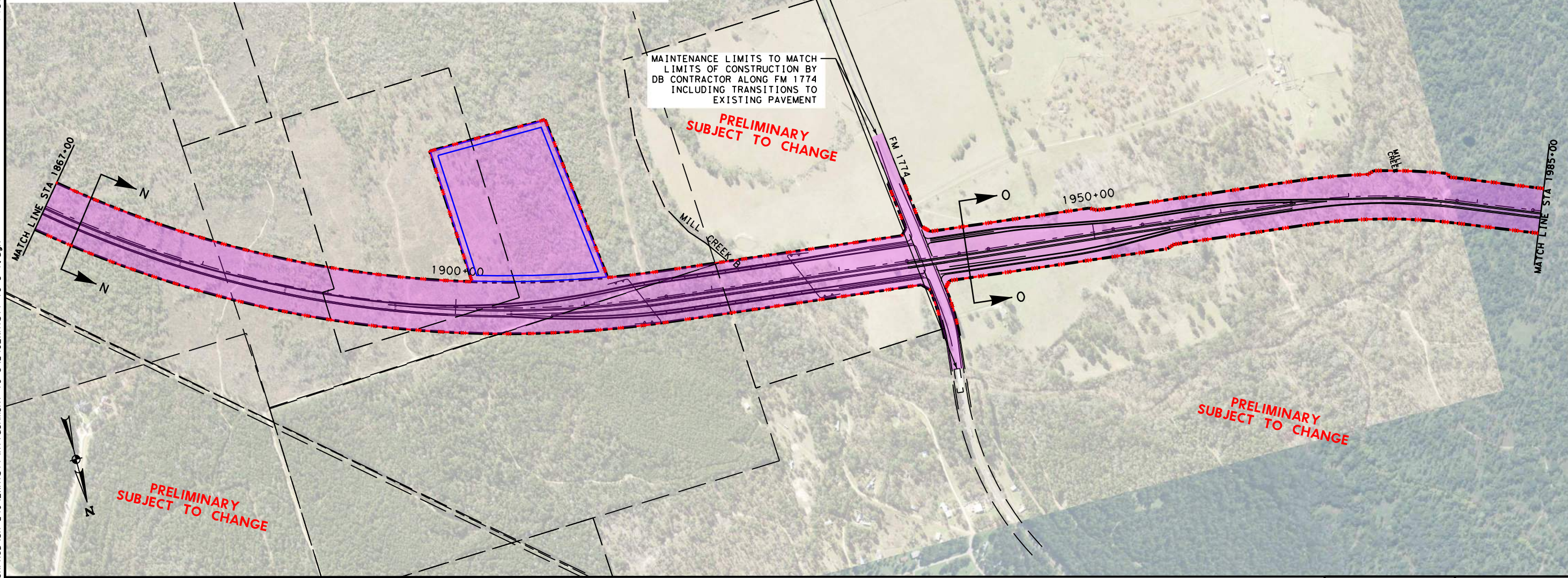
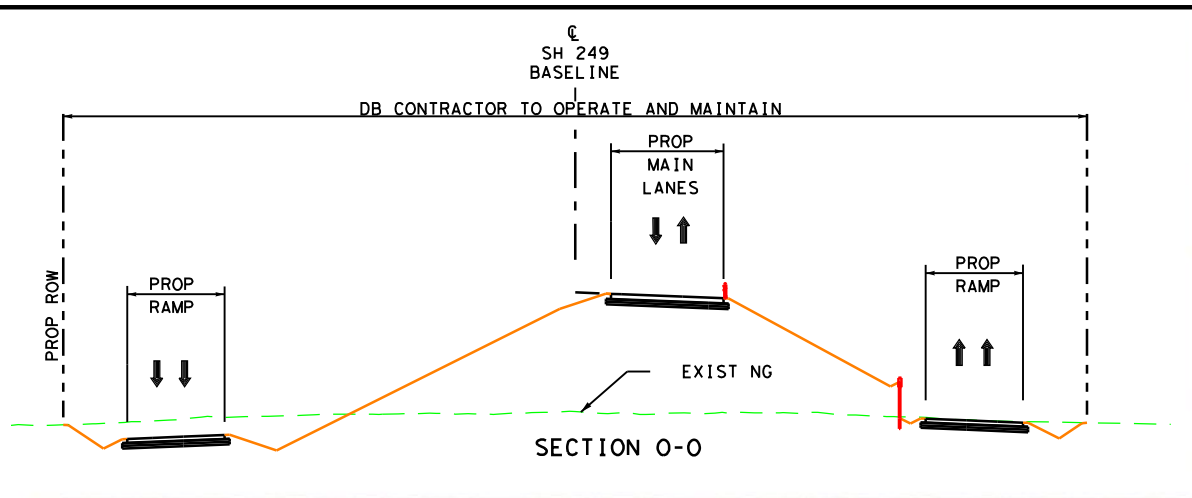

- LEGEND**
- LIMITS OF DB CONTRACTOR'S CONSTRUCTION, OPERATIONS, AND MAINTENANCE RESPONSIBILITIES
  - PROPOSED SH 249
  - PROP ROW
  - PROP CONTROL OF ACCESS
  - PROPOSED DETENTION POND
  - EXISTING ROW

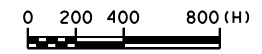

**ATTACHMENT 19-3  
 MAINTENANCE LIMITS  
 SEGMENTS 1 & 2**

DSN:	FED. RD. DIV. NO.	STATE	PROJECT NO.	HIGHWAY NO.
CK:		TEXAS		SH249
DRN:	STATE DISTRICT	COUNTY	CONTROL NO.	SECTION NO.
CK:				JOB NO. SHEET NO.
				7

Design File Name: \\hoxw00\jobs\59004\TECHPROD\SH 249\Exhibit\Attachment 19-3\249Exhibit\19-3\*7.dgn



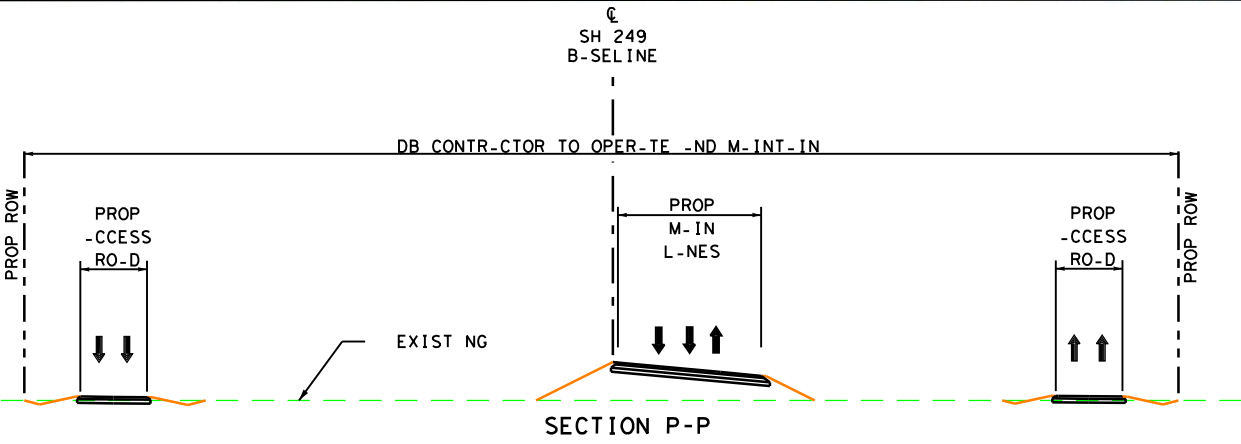
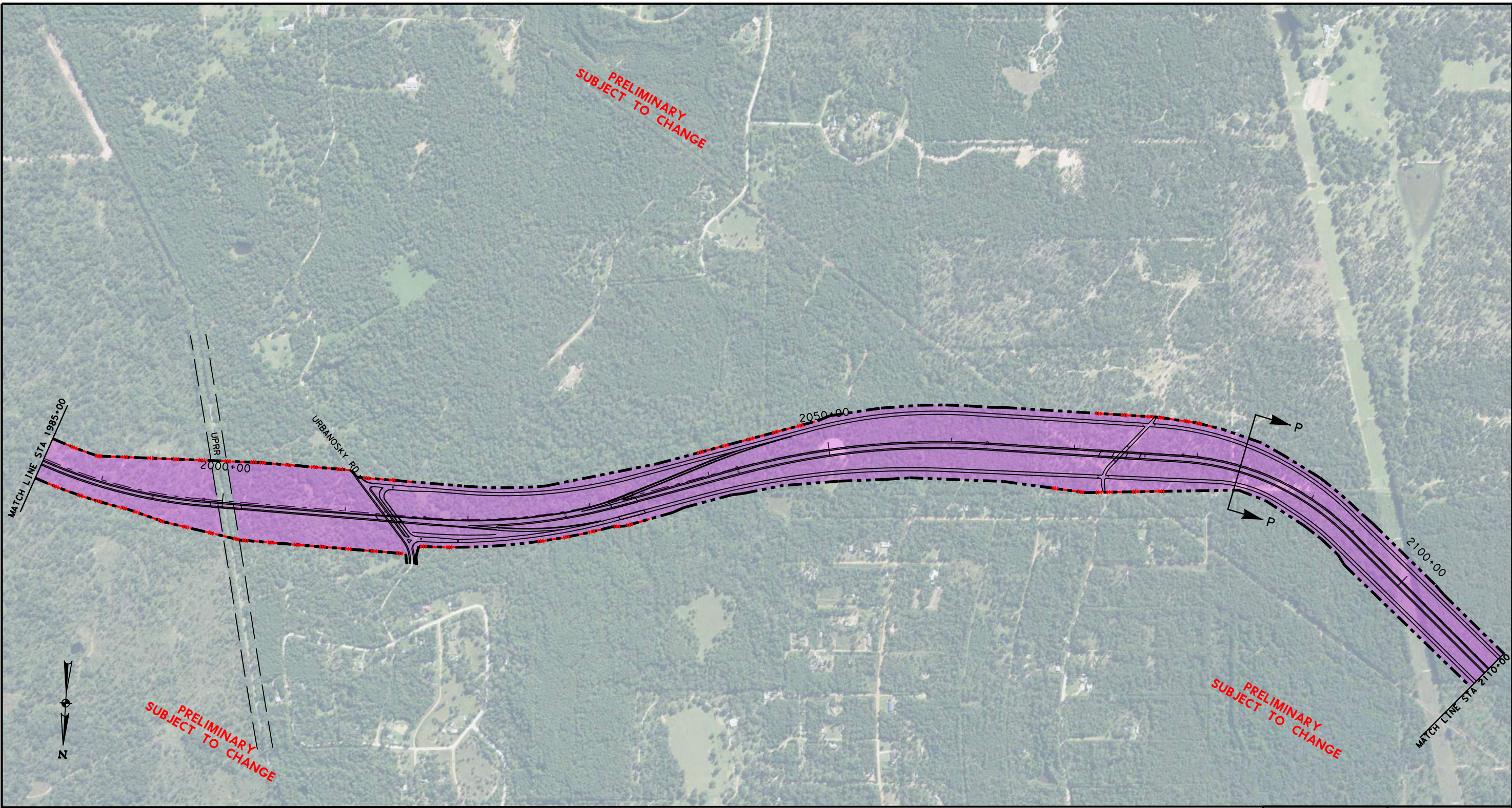

- LEGEND**
- LIMITS OF DB CONTR-CTOR'S CONSTRUCTION, OPER-ATIONS, -ND M-INTEN-CE RESPONSIBILITIES
  - PROPOSED SH 249
  - PROP ROW
  - PROP CONTOF -CCESS
  - PROPOSED DETENTION POND
  - EXISTING ROW



**ATTACHMENT 19-3  
 M-INTENANCE LIMITS  
 SEGMENTS 1 & 2**

DSN:	FED. RD. DIV. NO.	ST-TE	PROJECT NO.	HIGHWAY NO.
CK:		TEX-S		SH249
DRN:	ST-TE DISTRICT	COUNTY	CONTROL NO.	SECTION NO.
CK:				JOB NO.
				SHEET NO.
				8

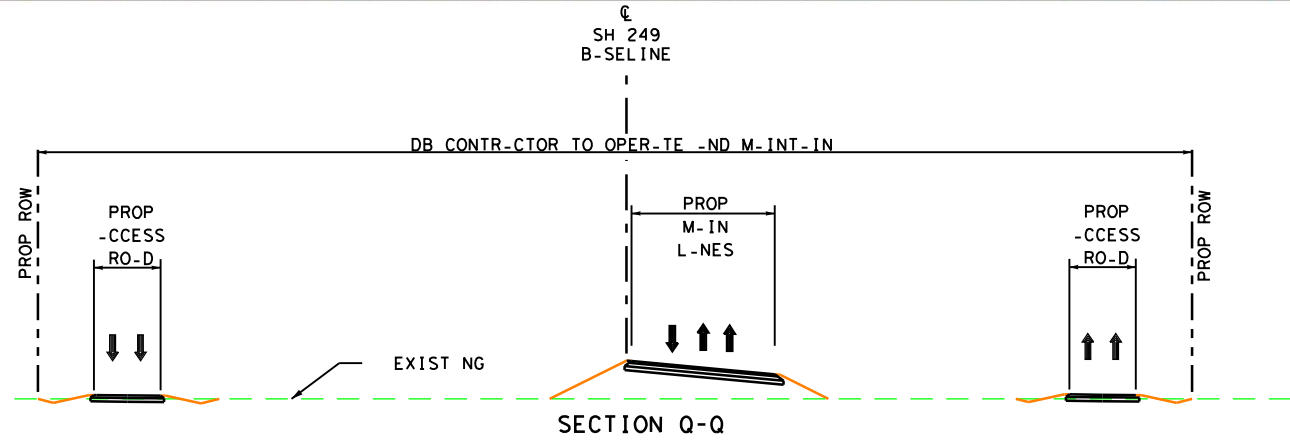
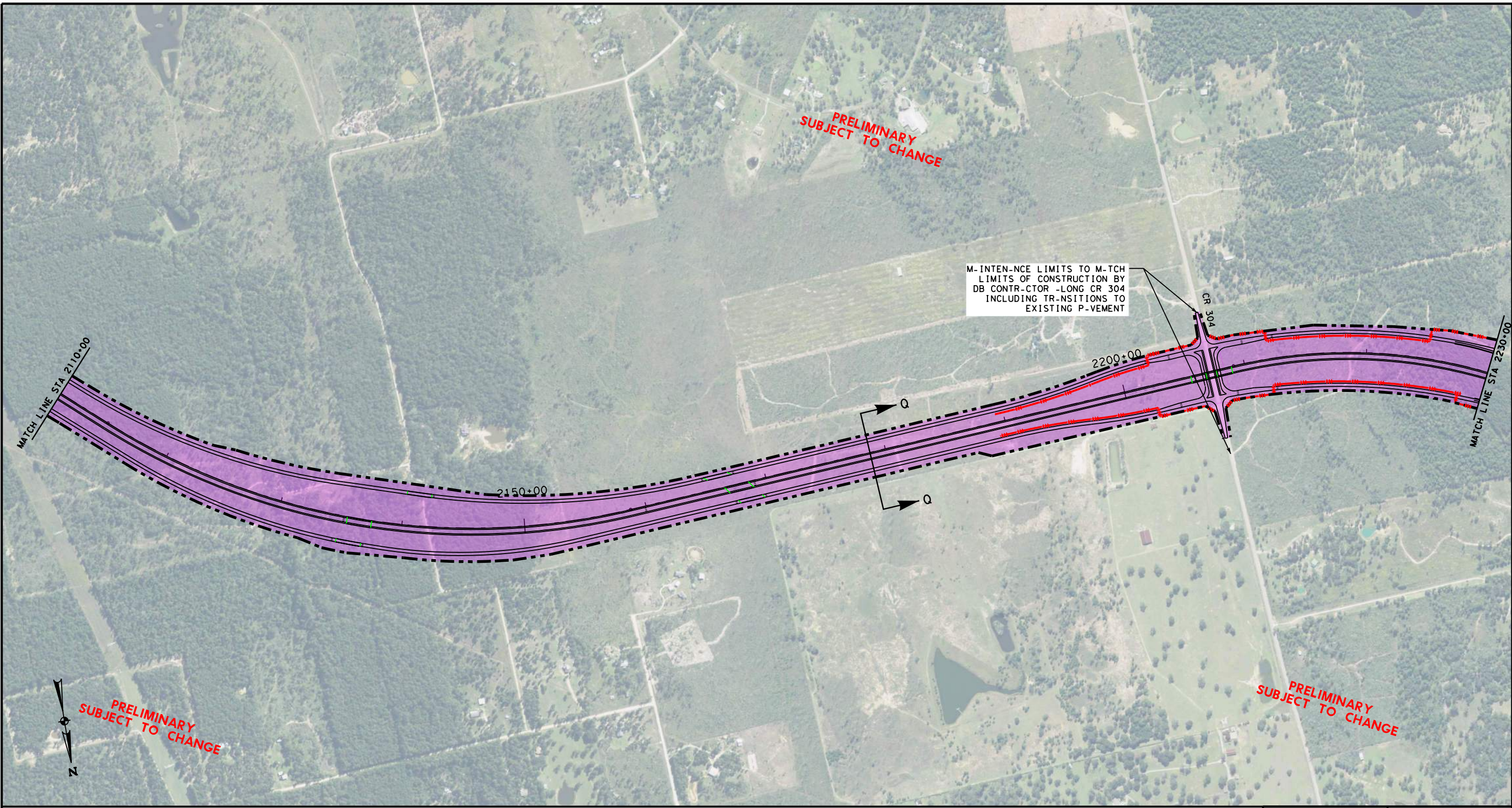

- LEGEND**
- LIMITS OF DB CONTR-CTOR'S CONSTRUCTION, OPER-TIONS, -ND M-INTEN-NCE RESPONSIBILITIES
  - PROPOSED SH 249
  - PROP ROW
  - PROP CONROL OF -CESS
  - PROPOSED DETENTION POND
  - EXISTING ROW
  - PROP ROW (GREEN OPTION)
  - PROP ROW (YELLOW OPTION)

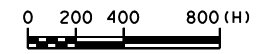

**ATTACHMENT 19-3  
 M-INTENANCE LIMITS  
 SEGMENTS 1 & 2**

DSN:	FED. RD. DIV. NO.	ST-TE	PROJECT NO.	HIGHWAY NO.
CK:		TEX-S		SH249
DRN:	ST-TE DISTRICT	COUNTY	CONTROL NO.	SECTION NO.
CK:				JOB NO.
				SHEET NO.
				9

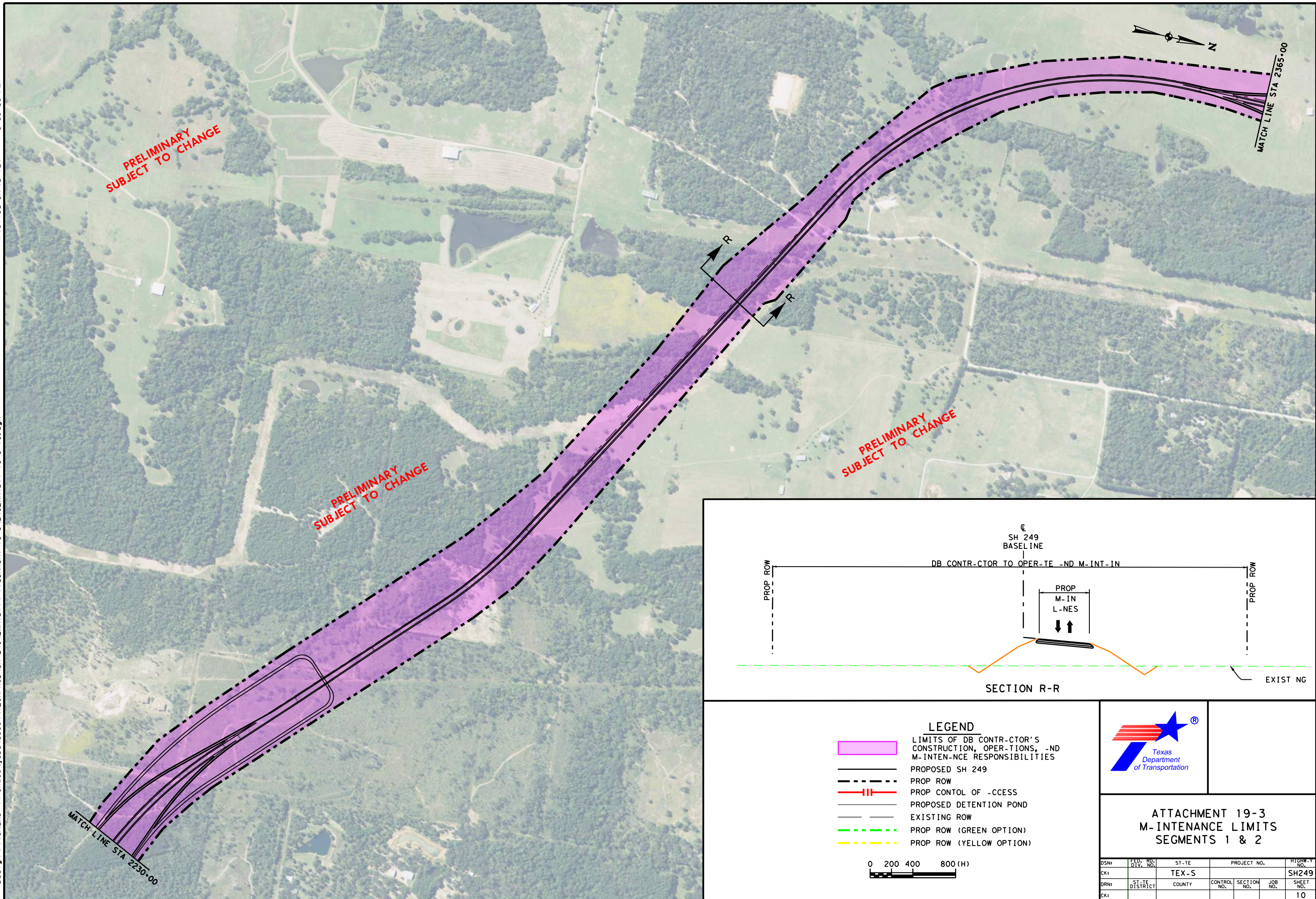

PRELIMINARY  
SUBJECT TO CHANGE

PRELIMINARY  
SUBJECT TO CHANGE

PRELIMINARY  
SUBJECT TO CHANGE

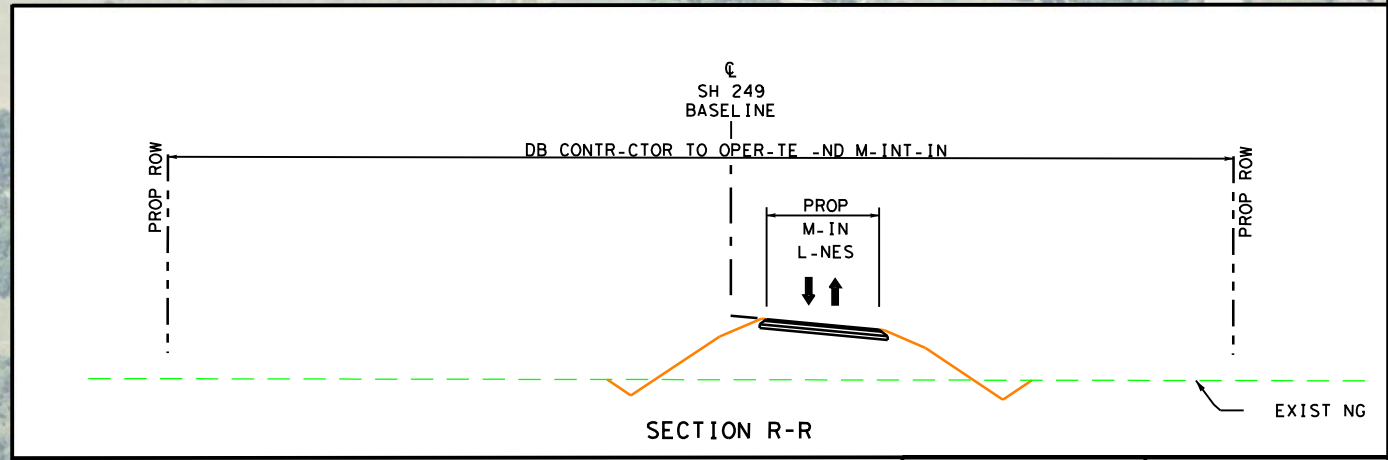

- LEGEND**
- LIMITS OF DB CONTRACTOR'S CONSTRUCTION, OPERATIONS, AND MAINTENANCE RESPONSIBILITIES
  - PROPOSED SH 249
  - PROP ROW
  - PROP CONTROL OF ACCESS
  - PROPOSED DETENTION POND
  - EXISTING ROW
  - PROP ROW (GREEN OPTION)
  - PROP ROW (YELLOW OPTION)

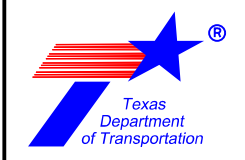
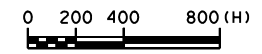

**ATTACHMENT 19-3  
 MAINTENANCE LIMITS  
 SEGMENTS 1 & 2**

DSN:	FED. RD. DIV. NO.	ST-TE	PROJECT NO.	HIGHWAY NO.
CK:		TEX-S		SH249
DRN:	ST-TE DISTRICT	COUNTY	CONTROL NO.	SECTION NO.
CK:				
				JOB NO.
				SHEET NO.
				10

Scale: \$SC-LE\$  
 Plotted on: \$D-TE\$ 4:00:32 PM

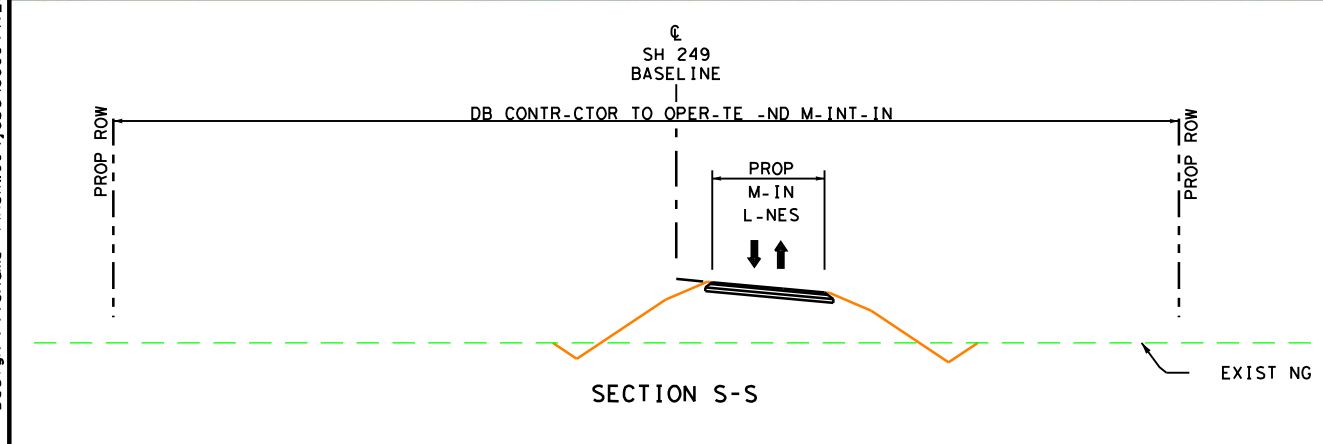
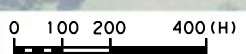
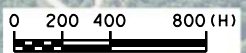
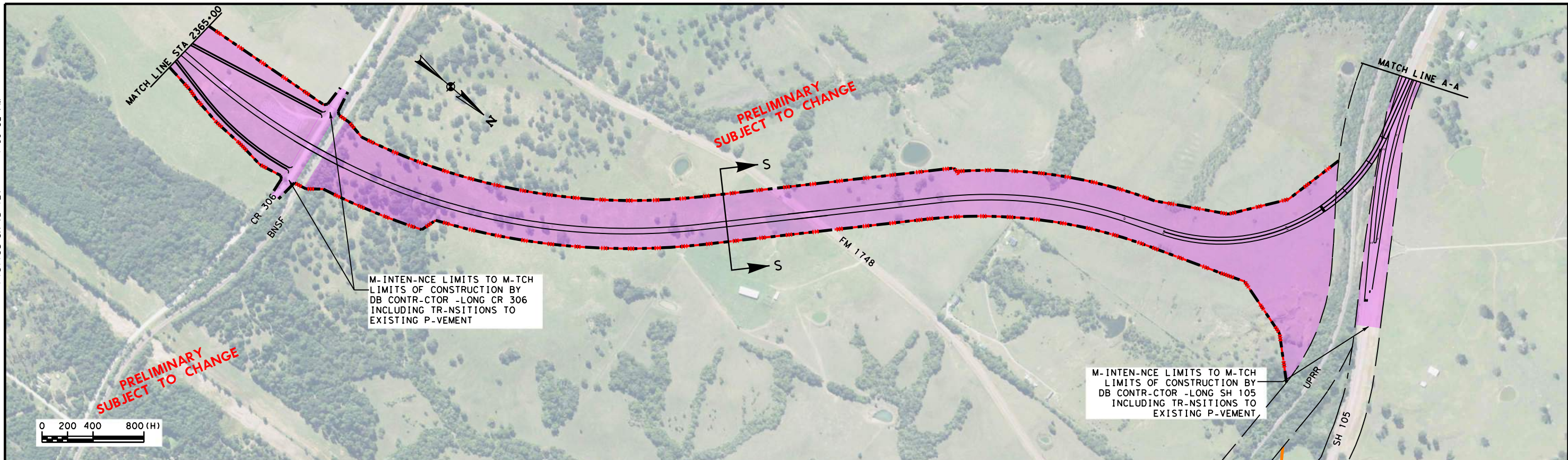

- LEGEND**
- LIMITS OF DB CONTR-CTOR'S CONSTRUCTION, OPER-TIONS, -ND M-INTEN-NCE RESPONSIBILITIES
  - PROPOSED SH 249
  - PROP ROW
  - PROP CONTOF -CCESS
  - PROPOSED DETENTION POND
  - EXISTING ROW



**ATTACHMENT 19-3  
 M-INTENANCE LIMITS  
 SEGMENTS 1 & 2**

DSN#	FED. RD. DIV. NO.	ST-TE	PROJECT NO.	HIGHW. NO.
CK#		TEX-S		SH249
DRN#	ST-TE DISTRICT	COUNTY	CONTROL NO.	SECTION NO.
CK#				JOB NO.
				SHEET NO.
				11

\$USER\$ Pen Table: \$PEN\$  
 Design File name: \\hoxw00\jobs\59004\TECHPROD\SH 249\Exhibit\attachment 19-3\249Exhibit\19-3\*11.dgn

Design File name: \\hoxw00\jobs\59004\TECHPROD\SH 249\Exhibit\attachment 19-3\249Exhibit\19-3\*11.dgn

Texas Department of Transportation  
Technical Provisions  
for  
SH 249 Extension

Attachment 19-4  
Maintenance Management Plan Template

February 9, 2017

# Maintenance Management Plan

---

**NAME OF PROJECT**  
**Contract #XXXXX**

**Day Month Year**

**Prepared By: DB Contractor's Name**  
**Street Address**  
**Suite XXX**  
**City Name, Texas XXXX**

# MAINTENANCE MANAGEMENT PLAN

For The

**NAME OF PROJECT**

Approved By:

\_\_\_\_\_  
FirstName LastName  
Maintenance Manager (MM) \_\_\_\_\_  
Date

\_\_\_\_\_  
FirstName LastName  
Maintenance Quality Manager (MQM) \_\_\_\_\_  
Date

\_\_\_\_\_  
FirstName LastName  
TxDOT's Authorized Representative \_\_\_\_\_  
Date

### Record of Revisions

Rev.	Date Issued	Pages Affected	Comments
0	XX/XX/XXXX	All	Initial Issue
1	XX/XX/XXXX	XX-XX	Add brief comment regarding revision

**Instructions to DB Contractor:**

*(These instructions to be removed from completed MMP)*

1. This Maintenance Management Plan (MMP) template defines the structure and required contents of the MMP. Use this template for each version and revision of the MMP submitted to TxDOT for approval.
2. Include the DB Contractor’s processes to achieve compliance with the obligations in the Contract Documents including the Performance Requirements. Describe who is responsible for each activity.
3. Processes should be clear, auditable, measurable, and achievable. Include control points at which the DB Contractor causes its own personnel or independent parties to verify that the work is in compliance with the contract. Identify points in the processes at which TxDOT is given the opportunity to witness or approve the work.
4. Identify the procedures (i.e. detailed steps) that will be utilized (see Appendix 13 for a listing of procedures that are needed at a minimum).
5. Version 1 of the MMP shall apply to Maintenance Work before Substantial Completion and Version 2 shall apply to Maintenance Services after Substantial Completion as shown on Table A1 below.

**Table A1: Versions of MMP**

<b>MMP Version</b>	<b>Maintenance Work / Maintenance Services governed by</b>	<b>First Submittal to TxDOT</b>	<b>Updates</b>	<b>Conditions</b>
Version 1 – Maintenance Work before Substantial Completion	Section 19 of Technical Provisions	No later than 30 days after issuance of NTP 1.	When required to conform to Good Industry Practice.	Approval by TxDOT shall be a condition to Segment 1 NTP 2.
Version 2 – Maintenance Services after Substantial Completion	Exhibit 2 to Capital Maintenance Agreement (CMA)	No later than 180 Days prior to anticipated Substantial Completion.	No later than 120 Days before each anniversary of Substantial Completion.	Approval by TxDOT shall be a condition to Substantial Completion.

6. Describe the MMP updating process so that TxDOT knows who will be performing what actions when.
7. The MMP is part of the Project Management Plan (PMP), see Figure A1 below. Section 2.1 of the DBA sets forth TxDOT’s approval rights and the conditions attached to its approval of the PMP. Section 5.5 of the CMA sets forth TxDOT’s approval rights and the conditions attached to its approval of the MMP.
8. Provide references to sections of the PMP applicable to Maintenance Work / Maintenance Services. Keep relevant sections of the PMP updated as needed throughout the Maintenance Period, for design work and construction work after Substantial Completion.



**Figure A1: MMP and MQMP Version 1 and Version 2**

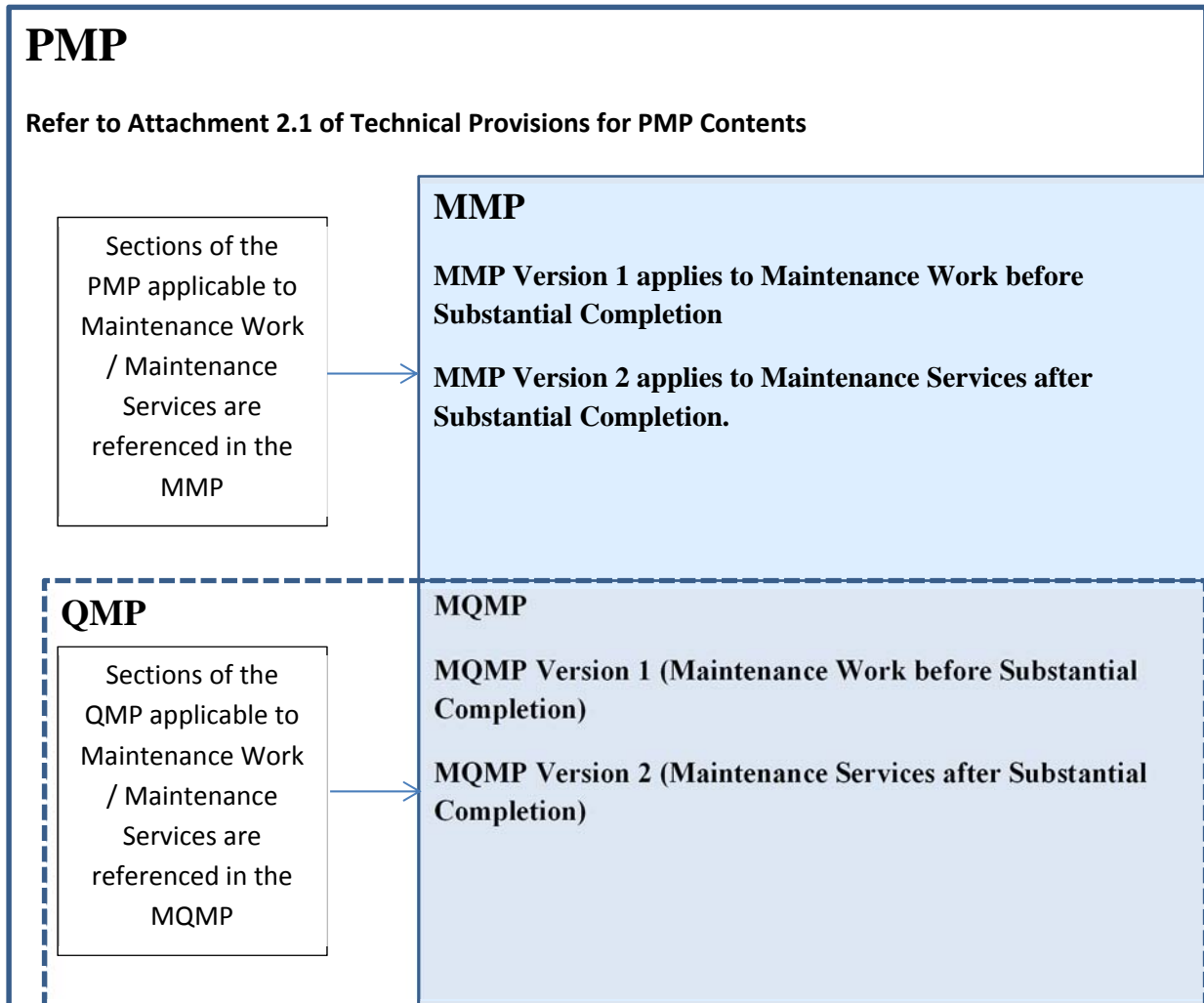

9. Do not duplicate the Technical Provisions within the MMP. Where necessary, cross reference relevant parts of the Technical Provisions.
10. Include within the MMP all Proposal Commitments and how TxDOT will be able to verify the Proposal Commitments have been fulfilled.
11. Ensure the MMP is consistent with the Preliminary MMP included with the Proposal.
12. Instructions to the DB Contractor are shown in this template in parentheses and italics and shall be removed prior to submittal of the MMP to TxDOT.
13. Include within the MMP a Project-specific timeline showing contract milestones, MMP and PMP versions and updates and MMP submittal milestones consistent with Figure A2.
14. Include references to all policies from the QMP applicable to Maintenance Work / Maintenance Services.

**Figure A2: Timeline for Contract Milestones, Maintenance Terms, MMP and PMP Versions and MMP Submittal Milestones**

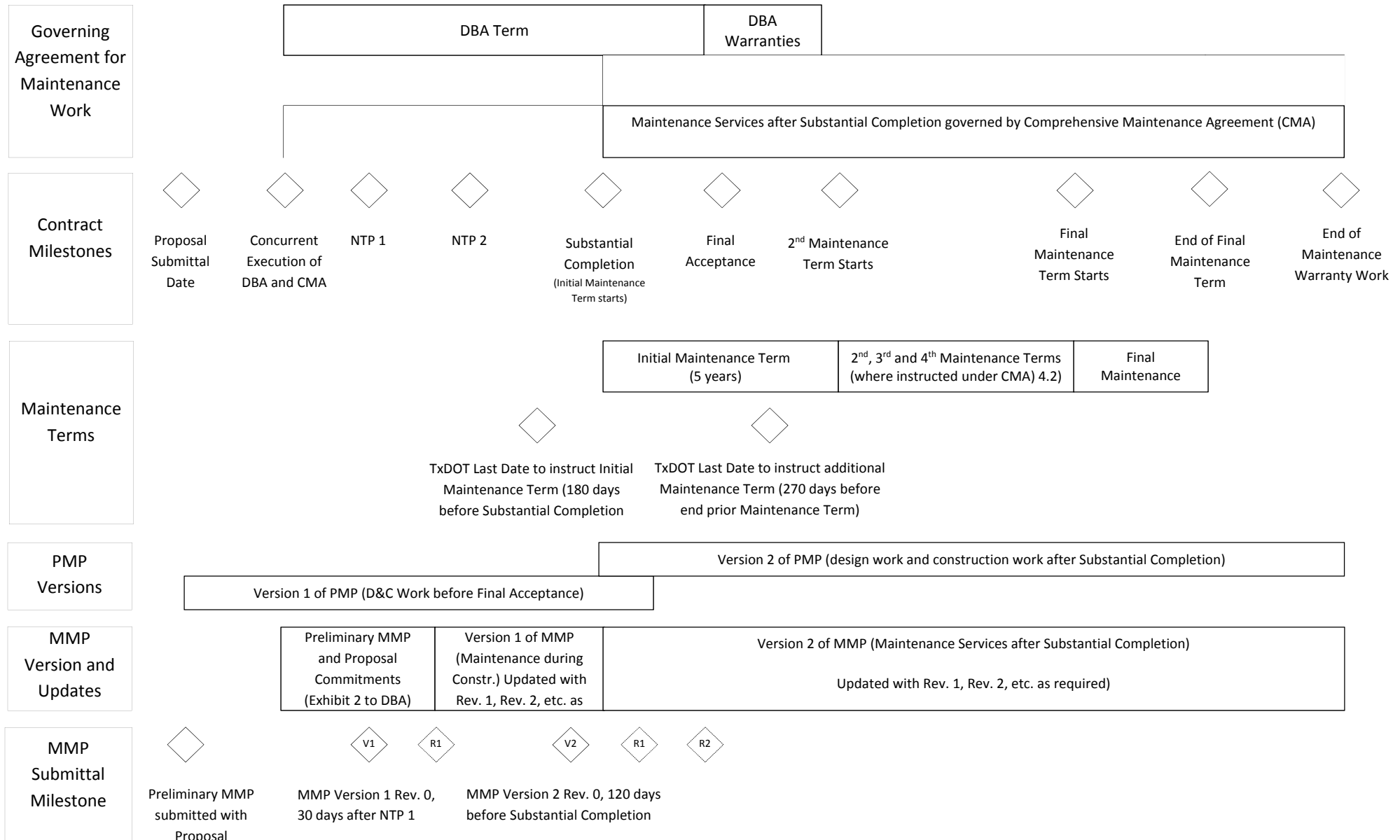

TABLE OF CONTENTS

**1. GENERAL MANAGEMENT AND ADMINISTRATION ..... 1**

1.1 Organization and Personnel ..... 1

1.1.1 DB Contractor Maintenance Organization Chart ..... 1

1.1.2 Qualifications, Experience necessary and training requirements for DB Contractor staff positions ..... 2

1.1.3 Personnel Training and Certification ..... 2

1.2 Communication Protocols ..... 3

1.2.1 Communications with TxDOT and other Governmental Entities ..... 4

1.2.1.1 Coordination during ITS integration and ITS operations ..... 4

1.2.1.2 Oversize / Overweight Permits ..... 4

1.2.2 Coordination with Utilities, Stakeholders and other 3<sup>rd</sup> Parties ..... 4

1.2.3 Internal Communications ..... 5

1.2.4 Public Information and Communications ..... 5

1.3 Project Meetings ..... 5

1.4 Document Control and Information Management ..... 6

1.5 Procurement and Subcontractors ..... 6

1.6 Monitoring and Control of Subcontractors ..... 7

1.7 Offices and Equipment ..... 7

1.8 Insurances ..... 8

**2. EMERGENCY RESPONSE ..... 8**

2.1 Incident Management Plan ..... 8

2.2 Snow and Ice Control Plan ..... 10

2.3 Severe Weather Evacuation Plan ..... 11

**3. ENVIRONMENTAL COMPLIANCE ..... 11**

3.1 Governmental Approvals and Permits ..... 11

3.2 Hazardous Material Management Plan ..... 11

3.3 SW3P Implementation ..... 12

3.4 Spill Prevention and Countermeasures Plan ..... 13

3.5 Pollution Prevention Plan (P2), Recycling Plan, and Waste Management ..... 13

3.6 Truck Routes, Hazardous Material Routes and related Approvals ..... 14

3.7 Environmental Compliance and Mitigation Plan ..... 14

**4. GOVERNING STANDARDS, MAINTENANCE LIMITS, RENEWAL WORK SCHEDULE AND MAINTENANCE SERVICES SUBMITTAL SCHEDULE..... 15**

4.1 Governing Standards Manuals Specifications and Guidelines ..... 15

4.2 Maintenance Limits, Layout and Limits of Performance Sections ..... 15

4.3 Renewal Work Procedure and Renewal Work Schedule ..... 15

4.4 Maintenance Services Submittal Schedule ..... 16

**5. COMPLIANCE WITH PERFORMANCE REQUIREMENTS..... 16**

5.1 Performance and Measurement Tables ..... 16

5.2 Maintenance Management System (MMS) ..... 16

5.2.1 Software ..... 16

5.2.2 Software Updates and Lifetime Compatibility with TxDOT’s MMS..... 16

5.2.3 Documentation and Forms ..... 16

5.3 Defects and Inspections ..... 16

5.4 Tracking and Reporting Noncompliance Events ..... 17

**6. MAINTENANCE SAFETY PLAN ..... 18**

**7. TRAFFIC MANAGEMENT PLAN..... 19**

7.1 Descriptions, Qualifications, Duties and Responsibilities of Traffic Personnel..... 19

7.2 Processes for Lane Closures and Traffic Control Plans..... 19

7.3 Public Information and Communications Plan.....20

**8. TRANSITION PLAN ..... 20**

8.1 Maintenance Transition Plan ..... 20

**9. MAINTENANCE QUALITY MANAGEMENT PLAN ..... 21**

9.1 Quality Management Organization ..... 21

9.2 Quality Policies ..... 22

9.3 MQMP Processes..... 22

**APPENDIX 1: STAFF REQUIREMENTS TABLE..... 24**

**APPENDIX 2: STAFF NAMES CONTACT DETAILS AND QUALIFICATIONS..... 24**

**APPENDIX 3: CONTACT DETAILS FOR TXDOT AND THIRD PARTIES..... 24**

**APPENDIX 4: PERMITS FOR GOVERNMENT AGENCIES AND THIRD PARTIES ..... 25**

**APPENDIX 5: CONTROLLING MANUALS, GUIDELINES AND SPECIFICATIONS ..... 25**

**APPENDIX 6: MAINTENANCE LIMITS AND LIMITS OF PERFORMANCE SECTIONS ..... 29**

**APPENDIX 7: RENEWAL WORK SUBMITTAL..... 29**

**APPENDIX 8: MAINTENANCE SERVICES SUBMITTAL SCHEDULE ..... 29**

**APPENDIX 9: PERFORMANCE AND MEASUREMENT TABLES..... 30**  
**APPENDIX 10: MAINTENANCE FACILITY LOCATION..... 30**  
**APPENDIX 11: INSURANCE VERIFICATION AND P&P BONDS..... 30**  
**APPENDIX 12: MAINTENANCE MANAGEMENT SYSTEM DETAILS ..... 30**  
**APPENDIX 13: MMP PROCEDURES ..... 31**  
**APPENDIX 14: TEMPLATE FOR TYPICAL PROCEDURE ..... 32**  
**APPENDIX 15: FORMS FOR MAINTENANCE PROCEDURES..... 34**  
**APPENDIX 16: QUALITY POLICIES AND PROCEDURES..... 34**

## 1. GENERAL MANAGEMENT AND ADMINISTRATION

### 1.1 Organization and Personnel

#### 1.1.1 DB Contractor Maintenance Organization Chart

Figure 1.1 below shows the organization chart for Maintenance Work before Substantial Completion and Figure 1.2 shows the organization chart for Maintenance Services after Substantial Completion.

*[Describe the organizational structure for each phase and how it will enable the DB Contractor's obligations for Maintenance Work / Maintenance Services to be met. Describe the reporting lines to TxDOT and internally. Describe the roles and responsibilities assigned to each position. Identify Major Subcontractors and describe the Maintenance Work / Maintenance Services to be performed by them. Describe continuity of organization and personnel between Maintenance Work before Substantial Completion and Maintenance Services after Substantial Completion. Insert the organization charts for both phases (before and after Substantial Completion) in Version 1. Update the organizational chart for Maintenance Services after Substantial Completion with Version 2.]*

#### Figure 1.1: Organization Chart for Maintenance Work before Substantial Completion

*[Insert organization chart showing reporting lines to include at a minimum:*

- *TxDOT Project Manager*
- *DB Contractor corporate management team*
- *DB Contractor Project Manager\**
- *Maintenance Manager\**
- *Maintenance Quality Manager\**
- *Maintenance Safety Manager\**
- *Individual responsible for customer service\**
- *Individual responsible for training program\**
- *Individual responsible for ensuring maintenance and life cycle issues are captured in the design with link to design and construction teams\**
- *Field crews responsible for Maintenance Work*
- *Field crews responsible for patrols, inspections, defect identification, categorization and remedy*
- *Field crews responsible for Incident and Emergency Management*

*For each individual (\*) identify the employing organization. Show positions and activities to be undertaken by Major Subcontractors.]*

**Figure 1.2: Organization Chart for Maintenance Services after Substantial Completion**

*[Insert organization chart showing reporting lines to include at a minimum:*

- *TxDOT Project Manager*
- *DB Contractor corporate management team*
- *Maintenance Manager\**
- *Maintenance Quality Manager\**
- *Maintenance Safety Manager\**
- *Individual responsible for training program\**
- *Individual responsible for assessing the condition of specified assets and scheduling Renewal Work\**
- *Field crews responsible for Maintenance Services for Maintained Elements*
- *Field crews responsible for inspections, Defect identification, categorization, and remedy*

*For each individual (\*) identify the employing organization. Show positions and activities to be undertaken by Major Subcontractors.]*

Appendix 1 shows every staff position delivering Maintenance Work / Maintenance Services in connection with the Project together with the TxDOT employee counterpart(s) with whom each staff member will regularly interact.

*[Include staffing for Maintenance Work before Substantial Completion in Version 1, and staffing for Maintenance Services after Substantial Completion in Version 2. Include at a minimum the individuals marked with (\*) on Figures 1.1 and 1.2, including individuals employed by subcontractors]*

**1.1.2 Qualifications, Experience necessary and training requirements for DB Contractor staff positions**

Appendix 2 shows the individual(s) assigned to staff positions with their positions, contact information (email and mobile phone number), education/qualifications, role, and summary of previous experience.

*[Include staffing for Maintenance Work before Substantial Completion in Version 1, and staffing for Maintenance Services after Substantial Completion in Version 2. For each staff member, provide evidence that personnel meet minimum training requirements. Include at a minimum the individuals required to be identified on the organization chart, including individuals employed by subcontractors]*

**1.1.3 Personnel Training and Certification**

Table 1.1 defines responsibility for development and implementation of training programs, who will be conducting the training and certification process for each staff position, including maintenance personnel, subcontractors and maintenance crew members on the topics below.

Forms documenting evidence of attendance and frequency/schedule of training updates to be attended by all relevant staff are shown in Appendix 15.

**Table 1.1: Training Program Matrix**

<b>Training Program</b>	<b>Person responsible to develop and deliver</b>	<b>Staff positions requiring training</b>	<b>Frequency of training</b>	<b>Link to training program</b>
Maintenance Management Plan training				
Inspections, Defect identification and categorization of Defects				
Hazardous materials, response and mitigation of Incidents involving contamination or waste, OSHA 1910.120 (HAZWOPER Training)				
Maintenance Safety Plan, equipment use, all safety-related activities and enforcement of safety operations				
CPR and first aid				
Work zone traffic control and flaggers in work zones				
Environmental impacts associated with Maintenance Work / Maintenance Services				
Operating railroad requirements prior to performing Maintenance Work / Maintenance Services or other activities affecting railroad property				
<i>[Other training programs (details to be added by DB Contractor)]</i>				

*[Include training for Maintenance Work before Substantial Completion in Version 1, and training for Maintenance Services after Substantial Completion in Version 2. Include at a minimum training requirements for the individuals required to be identified on the organization chart, including individuals employed by subcontractors]*

**1.2 Communication Protocols**

*[For Version 1 of the MMP (Maintenance Work before Substantial Completion) insert the required information below and refer to appropriate chapter and section from the PMP for all sub-sections of 1.2 (1.2.1 – 1.2.4).*



*For Version 2 of the MMP (Maintenance Services after Substantial Completion), transfer processes applicable to Maintenance Services, with suitable amendments from the PMP to the MMP]*

### **1.2.1 Communications with TxDOT and other Governmental Entities**

Refer to the following procedures in Appendix 13:

- MMP-001 –Submittals and Coordination with TxDOT, Other Agencies and Third Parties

For processes on meetings, reporting, written updates and immediate notifications on priority issues refer to *[Chapter X, Section X]* of the PMP.

Contact details for TxDOT, Government Entities, third parties, other stakeholders and their consultant offices with whom the DB Contractor will communicate are listed in Appendix 3.

[Within MMP-001 identify all adjacent highway agencies and address all interfaces with adjacent and connecting roadways.]

#### **1.2.1.1 Coordination during ITS integration and ITS operations**

For ITS integration before Substantial Completion refer to *[Chapter X, Section X]* of the PMP.

The following are maintenance interfaces with ETCS:

*[List the points of interfaces and include reference to diagrams or drawings showing interface lines and demarcations of responsibility for each tolling zone. Include updates consistent with progress of design].*

The contact details for the Toll Services Integrator are as follows:

*[List the contact details here]*

#### **1.2.1.2 Oversize / Overweight Permits**

The process for requests for permitting, issuance of permits and enforcement of permits through TxDOT is included in the following procedure in Appendix 13:

- MMP-002 –Agency Coordination for Oversize Loads

*[For Version 1 of the MMP (Maintenance Work before Substantial Completion) State how TxDOT will be notified of closures associated with permits and how updates for roadway clearances during construction will be provided.*

*For Version 2 of the MMP (Maintenance Services after Substantial Completion) State how TxDOT will be notified of closures associated with permits and how updates for roadway clearances during maintenance and Renewal Work will be provided.*

### **1.2.2 Coordination with Utilities, Stakeholders and other 3<sup>rd</sup> Parties**

Refer to the following procedures in Appendix 13:

- MMP-001 –Submittals and Coordination with TxDOT, Other Agencies and Third Parties

Table 1.2 below shows:

- Utilities, stakeholders and other third parties;

- In-house staff and specialized resources from the maintenance team responsible for coordination (including development and compliance with processes and the production of documentation) for each utility, stakeholder and other 3rd Party; and
- Reference to procedures contained in Appendix 13 specific to each named entity.

**Table 1.2: Coordination with Governmental Entities, Stakeholders, Utilities, and Third Parties**

Entity, Utility, stakeholder or third party	DB Contractor Personnel responsible for coordination	Reference to Procedure (specific to the named entity)

*[Insert Governmental Entity, utility and stakeholder or third party coordination responsibilities and processes for Maintenance Work before Substantial Completion in Version 1, and for Maintenance Services after Substantial Completion in Version 2. Include reference to individual procedures applicable to each entity, covering the following:*

- *Notification to entity of upcoming Maintenance Work / Maintenance Services that may affect the entity’s operations, e.g. Maintenance Work / Maintenance Services affecting adjacent business of utility interest*
- *Application by entity for access to inspect, repair, renew or replace its equipment within the Maintenance Limits]*

**1.2.3 Internal Communications**

For internal communications processes and responsible personnel before Substantial Completion, refer to *[Chapter X, Section X]* of the PMP.

For internal communications processes and responsible personnel after Substantial Completion, refer to

- MMP-001 –Submittals and Coordination with TxDOT, Other Agencies and Third Parties

**1.2.4 Public Information and Communications**

Refer to Section 7.3

**1.3 Project Meetings**

*[For Version 1 of the MMP refer to appropriate chapter and section from the PMP for meetings in connection with Maintenance Work before Substantial Completion.*

*For Version 2 of the MMP (Maintenance Services after Substantial Completion), complete the following information for meetings]*

The meeting types, topics, required participants and frequencies of meetings in connection with Maintenance Work / Maintenance Services shall be in accordance with Table 1.6.

**Table 1.6 Meetings In Connection with Maintenance Work / Maintenance Services**

<b>Meeting Type</b>	<b>Frequency</b>	<b>Attendees</b>
Monthly Maintenance Work review meeting	Monthly	TxDOT, Maintenance Manager, other senior personnel

*[Insert details of all other meetings in connection with the Maintenance Work / Maintenance Services including mandatory meetings required by TxDOT.]*

**1.4 Document Control and Information Management**

*[For Version 1 of the MMP refer to appropriate chapter and section from the PMP for document control and information management in connection with Maintenance Work before Substantial Completion.*

*For Version 2 of the MMP (Maintenance Services after Substantial Completion), complete the following information for document control and information management]*

Document Control and information management for Maintenance Work / Maintenance Services shall be as identified in Table 1.7.

**Table 1.7: Document Control and Information Management**

Person responsible for compliance with TxDOT maintenance and inspection of records requirements (DBA Section 21.4, CMA Section 17.5)	<i>[Insert name of individual or staff position]</i>
Procedures applicable	<i>[Insert references to applicable procedures]</i>
Document management EDMS software system	<i>[Insert details of software and reference to manuals]</i>
Person responsible for the storage and retention of Maintenance Records	<i>[Insert name of individual or staff position]</i>
<i>[Insert other requirements applicable to document control and information management]</i>	

**1.5 Procurement and Subcontractors**

Maintenance Work / Maintenance Services activities including Renewal Work that will be subcontracted are shown in Table 1.8 below.

**Table 1.8: Details of Subcontractors Performing Maintenance Work / Maintenance Services**

Name of Subcontractor and start date	Key contact details	Work responsibility

*[Add details of each subcontractor within the time periods permitted in the DBA or CMA as applicable.]*

**1.6 Monitoring and Control of Subcontractors**

The following procedure contained in Appendix 13 is designed to ensure all subcontractors’ work is adequately monitored and action taken in the event of noncompliance:

- MMP-003 – Quality Control of Subcontractors Activities and Products.

*[Include within MMP-003 processes and responsibility for:*

- (i) Issuing instructions to subcontractors, including consultants and subconsultants*
- (ii) Ensuring steps taken to ensure subcontractors and suppliers meet the obligations imposed by their respective subcontracts*
- (iii) Monitoring the work of subcontractors, issuing noncompliance or nonconformance notices and providing feedback*
- (iv) Ensuring training for employees of Subcontractors.]*

**1.7 Offices and Equipment**

Refer to the following procedure in Appendix 13:

- MMP-004 – Maintenance of Facilities, Vehicles and Equipment Plan

The physical location and layout of the Maintenance Facility consistent with the requirements of Section 2.11 of the Technical Provisions is shown in Appendix 10.

*[To be provided for Version 1 of the MMP (Maintenance Work before Substantial Completion), only. Provide location and map (if different than the Roadway Maintenance office) of the maintenance facility for equipment maintenance and storage and for the de-icing material storage, if applicable.]*

*[Provide current versions and procedures, functionality, software maintenance requirements and access protocols for all specialist software employed by DB Contractor in connection with the Maintenance Services.]*

The physical address is *[insert address]*

The 24-hour contact number is *[insert number]*.

### **1.8 Insurances**

The checklist of all required insurances required for the Maintenance Work / Maintenance Services with dates on which policies were renewed and evidence/dates proof of insurance was provided to TxDOT consistent with the requirements of *Section 9.1 of the DBA, Section 7.7 of the CMA* (Verification of Coverage and P&P Bonds) are included in Appendix 11. The Payment and Performance Bonds required for the Maintenance Work / Maintenance Services was provided to TxDOT consistent with the requirements of Section 8.1 of the DBA, Section 7.4 of the CMA (Verification of Coverage and P&P Bonds) are included in Appendix 11

## **2. EMERGENCY RESPONSE**

### **2.1 Incident Management Plan**

*[To be provided for Version 1 of the MMP (Maintenance Work before Substantial Completion), only. For Version 1 of the MMP, include all information below as a stand-alone plan]*

The Incident Management Plan (IMP) contains the approach to Incident management consistent with *Section 19.5.1 of the Technical Provisions, Section 4.2 of CMA Exhibit 2*, training requirements and staffing requirements for response to Incidents and Emergencies, and includes protocols, processes, and guidelines to mitigate the impacts, respond to and recover from all such events. The IMP has been prepared in coordination with and including input from the following organizations:

*[Insert Project-specific list of consultees, dates of consultation and evidence of actively seeking input and feedback, to include TxDOT, Emergency Services, owners of Related Transportation Facilities and applicable Governmental Entities.]*

The command structure for Incident Management is shown in Figure 2.1.

Figure 2.1: Command Structure for Incident Management

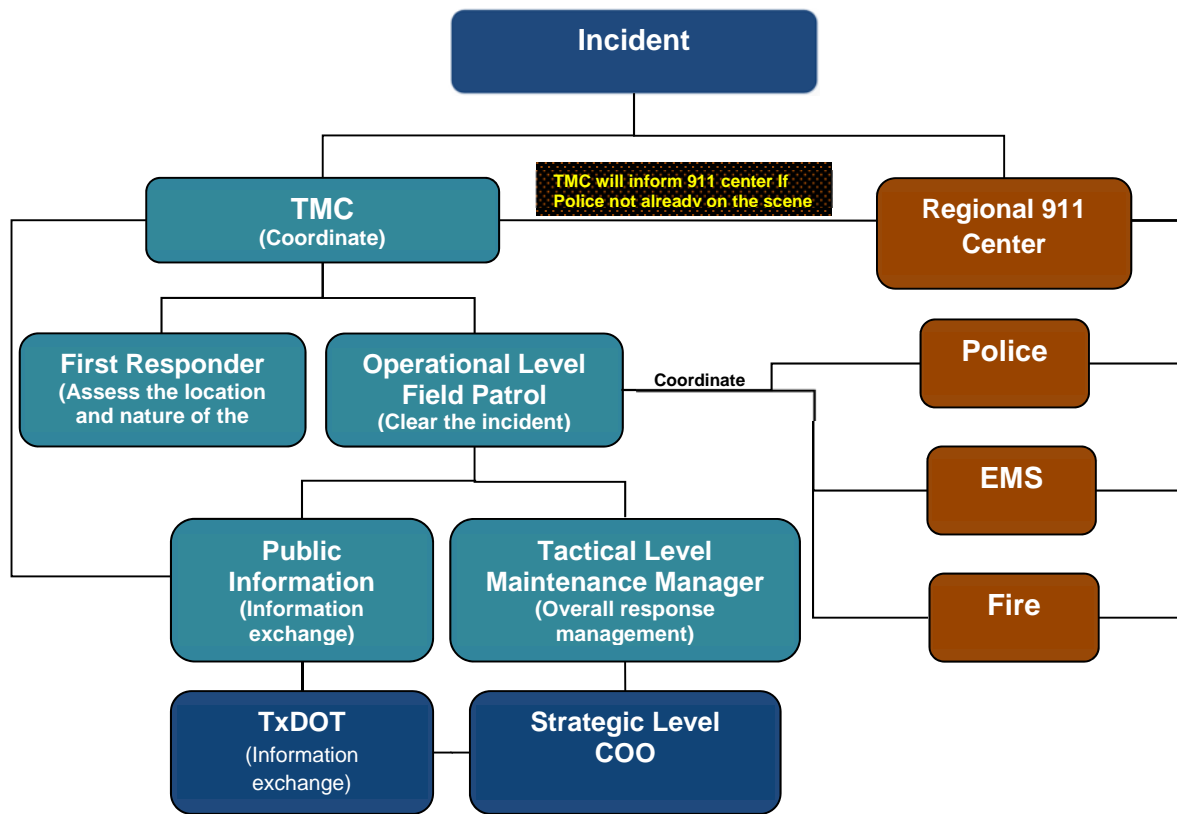

*[Replace example Command Structure by Project-specific chart of equivalent detail that includes Project-specific details of Emergency Services and TxDOT contacts]*

The following procedures in Appendix 13 are part of the IMP:

- MMP-005 – Emergency and Incident Management.
- MMP-006 – Incident Damage Reports, Third Party Claims and Repairs
- MMP-007 – Complaint Review and Response
- MMP-008 – Customer Satisfaction Data Collection System

*[Include within the IMP, processes and responsibilities for:*

- (i) Identification of Incidents of differing categories (minor, major, critical) and notification of Emergency Services providers*
- (ii) Rapid and reliable establishment of traffic control for Incident management*
- (iii) Removal by towing and recovery of stalled, broken down, wrecked or otherwise incapacitated vehicles from the travel lane, including coordination with Emergency Services/law enforcement*

- (iv) *Clearance of Incident and return affected lanes to normal use within the specified period of arriving at the Incident site*
- (v) *Cleanup of debris, oil, broken glass and other such objects foreign to the roadway surface*
- (v) *Notification of the public of traffic issues related to Incidents*
- (vi) *Seeking feedback from TxDOT, emergency services and law enforcement and improving processes to improve response times.*
- (vii) *Contact methods, personnel available, and response times for any Emergency condition requiring attention during off-hours*
- (viii) *Identification and containment of all Hazardous Material spills and appropriate disposal of such materials.]*

*[For Version 2 of the MMP (Maintenance Services after Substantial Completion), complete the following information]*

- (i) *Procedures for working with TxDOT after Incidents to rapidly perform joint inspections, change order submittal, and work plan for resolving damage to Maintained Elements.]*

## **2.2 Snow and Ice Control Plan**

*[To be provided for Version 1 of the MMP (Maintenance Work before Substantial Completion), only.]*

The Snow and Ice Control Plan (SICP) contains operational processes for performing snow and ice control work. The SICP complies with all applicable Law, codes, and regulations governing the operation of equipment on public highways. The SICP will be updated at least annually to incorporate any changes in strategy and equipment levels designed to rectify any noncompliances in snow and ice removal operations during the preceding winter season.

The following procedure contained in Appendix 13 is part of the Snow and Ice Control Plan (SICP).

- MMP-009 – Snow and Ice Control / Clean-up Plan.

*[Include within the SICP processes and responsibilities for:*

- (i) *Receiving weather forecasts and making decisions for snow and ice control based upon analysis of data received*
- (ii) *Advance preparation and call-out*
- (iii) *Training in connection with snow and ice control*
- (iv) *Record keeping/ reporting including maintaining records of compliance with the Performance Requirements*
- (v) *Environmental management and processes for using preventative measures, involving use of anti-icing and de-icing chemicals such as salt and alternative substances, including storage and application*
- (vi) *A list of the equipment and materials available for snow and ice control including its current location and methods to guarantee its availability for use.]*

*[For Version 2 of the MMP (Maintenance Services after Substantial Completion), complete the following information for snow and ice control]*

- (i) *Procedures for working with TxDOT to provide Maintenance Services to the Maintained Elements following a winter storm / TxDOT snow and ice activities*
- (ii) *Cleaning and sweeping responsibilities related to clean-up after winter events to minimize impact to drainage systems and structures.]*

### **2.3 Severe Weather Evacuation Plan**

*[To be provided for Version 1 of the MMP (Maintenance Work before Substantial Completion), only.]*

The Severe Weather Evacuation Plan (SWEP) contains operational processes for evacuation. The SWEP complies with all applicable Law, codes, and regulations governing the operation of equipment on public highways. The SWEP will be updated at least annually to incorporate any changes in strategy and evacuation routes during the previous year.

The following procedure in Appendix 13 is part of the SWEP:

- MMP-010 – Severe Weather Evacuation Plan.

*[Include within the SWEP a process and the individual responsible for each of the following:*

- (i) *Receiving weather forecasts and making decisions for evacuation based upon analysis of data received*
- (ii) *Advance preparation and call-out*
- (iii) *Training in connection with evacuation processes*
- (iv) *Record keeping / reporting including maintaining records of compliance with the Performance Requirements*
- (v) *Develop evacuations zones and evacuation guides with routes.]*

## **3. ENVIRONMENTAL COMPLIANCE**

### **3.1 Governmental Approvals and Permits**

The required permits for government agencies and third parties as part of the Maintenance Work / Maintenance Services are included in Appendix 4.

### **3.2 Hazardous Material Management Plan**

The Hazardous Materials Management Plan (HMMP) governs the safe handling, storage, treatment and/or disposal of Hazardous Materials, whether encountered at or brought onto the Project by the DB Contractor, encountered or brought onto the Project by a third party, or otherwise.

The following designated individuals are responsible for management of Hazardous Materials, including development of processes compliant with all applicable Environmental Laws:

*[Include names, contact details and applicable certifications and licenses of designated individuals]*

The following designated individual is responsible to ensure that:



- All personnel delivering the Maintenance Work / Maintenance Services who may be expected to handle Hazardous Materials have been trained and certified at least to the minimum requirements established under the guidelines of OSHA 1910.120 (HAZWOPER Training)
- All applicable certifications, licenses, authorizations and Governmental Approvals for DB Contractor personnel handling Hazardous Materials are current and valid.

*[Include name, contact details and applicable certifications and licenses of designated individual]*

The following procedure in Appendix 13 is part of the HMPP.

- MMP-011 – Hazardous Material Management Plan.

*[For Version 1 of the MMP (Maintenance Work before Substantial Completion)]* The HMPP is at *[Chapter X, Section X]* of the PMP.

*[For Version 2 of the MMP (Maintenance Services after Substantial Completion), transfer the applicable procedures to the MMP and include within the HMPP processes and responsibilities for:*

- (i) Updating safety data sheets, per OSHA requirements, for all chemicals used in connection with the Maintenance Services*
- (ii) Identification and documentation of potential contaminated sites which might impact Users or the performance of the Maintenance Services*
- (iii) Mitigation of contamination encountered during the Maintenance Services*
- (iv) A project-specific spill response plan including the prevention, control, and mitigation of fugitive noxious or toxic vapors or particulate matter (dust), contaminated soil, and contaminated groundwater during disturbance of noxious or hazardous materials and media*
- (v) Training of personnel for responding to and mitigating Incidents involving contamination or waste including a Hazardous Materials training module and worker training awareness so that workers recognize the potential Hazardous Materials to which they may be exposed*
- (vi) Provisions for appropriate storage and disposal of all waste encountered or disposed of on the Project*
- (vii) An Investigative Work Plan (IWP) and Site Investigative Report (SIR) in the event that Hazardous Materials are discovered during Maintenance Services*
- (vii) List of all personal protection equipment available to protect workers from exposure in connection with the Maintenance Services.]*

### **3.3 SW3P Implementation**

Maintenance Work / Maintenance Services will be undertaken in compliance with the TCEQ Texas Pollutant Discharge Elimination System (TPDES) Construction General Permit in accordance with the TxDOT Storm Water Management and Guidelines for Construction Activities Manual.

Refer to the following procedure in Appendix 13:

- MMP-012 Implementation of SW3P After Substantial Completion

*[For Version 1 of the MMP (Maintenance Work before Substantial Completion)]* The SW3P is at *[Chapter X, Section X]* of the PMP.

*[For Version 2 of the MMP (Maintenance Services after Substantial Completion) transfer only the requirements applicable to Renewal Work of the SW3P to the MMP and provide processes and responsibilities for:*

*Project-specific decision criteria regarding the types of Maintenance Services for which the SW3P requirements shall be followed (e.g. for any activity disturbing soil.)]*

### **3.4 Spill Prevention and Countermeasures Plan**

The following procedure is part of the Spill Prevention and Countermeasures Plan:

- MMP-013: Implementation of Spill Prevention and Countermeasures Plan

*[For Version 1 of the MMP (Maintenance Work before Substantial Completion)]* The Spill Prevention and Countermeasures Plan (SPCP) is at *[Chapter X, Section X]* of the PMP.

*[For Version 2 of the MMP (Maintenance Services after Substantial Completion) transfer only the requirements applicable to Renewal Work of the SPCP to the MMP and include the following:*

- State that the goal for Maintenance Services is to have one hundred percent compliance with the requirements of the SW3P and TXR 150000 and zero violation notices.*
- Specify minimum increments for internal audits to be conducted of the contractor's compliance with the SPCP to assess whether these goals were achieved through review of environmental documentation*
- State the circumstances when the DB Contractor will employ an Environmental Compliance Manager for Maintenance Services (e.g. for any activity that requires permitting)].*

### **3.5 Pollution Prevention Plan (P2), Recycling Plan, and Waste Management**

The Pollution Prevention (P2) Plan is prepared in accordance with the Texas Waste Reduction Policy Act. Refer to the following procedures in Appendix 13:

- MMP-014 Implementation of Pollution Prevention Plan
- MMP-015 Implementation of Waste Management
- MMP-016 Implementation of Recycling Plan

*[For Version 1 of the MMP (Maintenance Work before Substantial Completion)]* The Pollution Prevention Plan is at *[Chapter X, Section X]* of the PMP.

*[For Version 2 of the MMP (Maintenance Services after Substantial Completion) transfer only the requirements applicable to Renewal Work of the Pollution Prevention Plan to the MMP and include the following criteria consistent with the Texas Waste Reduction Policy Act:*

- (i) *Large and small quantity generators of hazardous waste*
- (ii) *Toxics Release Inventory (TRI)*
- (iii) *A list of all hazardous wastes and TRI chemicals*
- (iv) *The activities that generate the waste or TRI chemical*
- (v) *An explanation of P2 projects*
- (vi) *An implementation schedule*
- (vii) *The measurable P2 goals*
- (viii) *An employee awareness program (refer here to section 1.1.3)*
- (ix) *A P2 Plan Executive Summary.]*

### **3.6 Truck Routes, Hazardous Material Routes and related Approvals**

*[For Version 1 of the MMP (Maintenance Work before Substantial Completion)]* Truck Routes, Haz-Mat Routes and associated approvals are at *[Chapter X, Section X]* of the PMP.

### **3.7 Environmental Compliance and Mitigation Plan**

Refer to the following procedures in Appendix 13:

- MMP-018 – Implementation of Environmental Procedures and Training
- MMP-019 – Mitigation Procedures for Impacts to Neighboring Facilities

The Environmental Compliance and Mitigation Plan (ECMP) includes compliance strategies and processes to be employed in accordance with the requirements of applicable Environmental Laws and Environmental Approvals. Maintenance Work / Maintenance Services will be undertaken in compliance with the ECMP and the Environmental Commitments.

Refer to section 1.1.3 for education and training requirements for all project personnel.  
Refer to section 9 – Maintenance Quality Management Plan for:

- Conveying a commitment to the Project's environmental quality to all employees;
- Conveying a commitment to zero tolerance for violations; and
- Ensuring that environmental requirements are reflected in maintenance processes.

*[For Version 1 of the MMP (Maintenance Work before Substantial Completion)]* The ECMP is at *[Chapter X, Section X]* of the PMP.

*[For Version 2 of the MMP (Maintenance Services after Substantial Completion) transfer only the requirements applicable to Renewal Work of the ECMP to the MMP and include processes and responsibilities for:*

- (i) *Maintaining the Environmental Commitments for all Maintenance Services including Project-specific identification of significant Environmental Commitments that will require monitoring after Substantial Completion*
- (ii) *Verification that any discharge from the Project into a sanitary sewer system complies with appropriate codes and standards of the sanitary sewer owner*
- (ii) *Identification and mitigation of any potential traffic noise caused by Maintenance Services*

- (iii) *Environmental monitoring within the Project area and submittal of all necessary environmental documentation and monitoring reports to the appropriate Governmental Entities and, when applicable, to TxDOT, to the extent necessary to maintain compliance with applicable Environmental Approvals*
- (iv) *Training personnel to avoid or take appropriate action to minimize environmental impacts caused by Maintenance Services.]*

#### **4. GOVERNING STANDARDS, MAINTENANCE LIMITS, RENEWAL WORK SCHEDULE AND MAINTENANCE SERVICES SUBMITTAL SCHEDULE**

*[The following are required in Version 1 of the MMP and shall be updated for Version 2]*

##### **4.1 Governing Standards Manuals Specifications and Guidelines**

In accordance with Section 3 of the CMA, the Parties anticipate that from time to time after the Proposal Due Date, changes will be published to manuals, specifications and guidelines. Appendix 5 contains an updated list of the most recently published versions of manuals, specifications and guidelines pertaining to the Maintenance Services. Appendix 5 also includes new manuals, specifications and guidelines that have been added to ensure the Maintenance Services are delivered in accordance with Good Industry Practice. The list will be reviewed with TxDOT at least annually on the anniversary of the commencement of the Maintenance Services. The person responsible for reviewing and updating Appendix 5 is *[Insert person responsible]*.

##### **4.2 Maintenance Limits, Layout and Limits of Performance Sections**

Schematic Drawings showing the Maintenance Limits and the extents of the Performance Sections are included in Appendix 6, consistent with the requirements of *Section 19.2 of the Technical Provisions, Attachment 3 to the CMA Exhibit 2*.

*[For Versions 1 and 2 of the MMP include processes and responsibilities for:*

- (i) Periodically validating that the Maintenance Limits are correctly and clearly identified in the field*
- (ii) Liaison with TxDOT and Governmental Entities at least annually to review the Maintenance Limits, identify any jurisdictional gaps or inefficiencies and recommend solutions]*

##### **4.3 Renewal Work Procedure and Renewal Work Schedule**

The Renewal Work Schedule is included in Appendix 7 in accordance with *Section 2.5 of CMA Exhibit 2*.

The approach to Renewal Work consistent with Section 2.1 of CMA Exhibit 2 is described in the following procedure in Appendix 13.

- MMP-020 – Renewal Work

*[For Version 2 of the MMP include processes and responsibilities for:*

- (i) Determining when any element requires Renewal Work*
- (ii) Updating the Renewal Work Schedule and preparing the Renewal Work Submittal as required]*

#### **4.4 Maintenance Services Submittal Schedule**

*[The following is required in Version 2 of the MMP]*

The Maintenance Services Submittal Schedule is included in Appendix 8 in accordance with Section 3 of CMA Exhibit 2.

### **5. COMPLIANCE WITH PERFORMANCE REQUIREMENTS**

*[The following are required in Version 1 of the MMP and shall be updated for Version 2]*

#### **5.1 Performance and Measurement Tables**

Appendix 9 to the MMP contains the most recent approved versions of the Performance and Measurement Tables updated in accordance with Section 1.3.1 of CMA Exhibit 2.

#### **5.2 Maintenance Management System (MMS)**

Refer to the following procedure in Appendix 13:

- MMP-021 – Establishing Maintenance Management System

##### **5.2.1 Software**

The software for the MMS is *[Insert the name of the software]*. The individual responsible for maintaining the system and ensuring required access for TxDOT is *[Insert name of individual]*

Appendix 12 includes a link to the MMS software user guide including:

- Customization undertaken in connection with the Project
- Sample reports of the MMS software that provides evidence of compliance with Section 1.6 of CMA Exhibit 2.
- Links to MMS training including a record of the most recent MMS demonstration provided to TxDOT.

##### **5.2.2 Software Updates and Lifetime Compatibility with TxDOT's MMS**

Version *[.. ]* of the software will be initially used. Software updates will be noted under this section and update details will be available at the software's manual in Appendix 12.

The MMS software is fully compatible with TxDOT's MMS as demonstrated at the software's manual (pages *[.. ]*) and at the data transferability process and reports that can be found in Appendix 12.

##### **5.2.3 Documentation and Forms**

Documentation and Forms needed to verify and enter the field gathered data to the MMS software can be found in Appendix 12.

#### **5.3 Defects and Inspections**

Refer to the following procedures in Appendix 13:

*[The following are required for both Version 1 and Version 2 of the MMP]*

- MMP-022 – Defect Categorization and Repair

- MMP-023 – Maintenance Inspection Plan
- MMP-024 – Maintenance Repair Submittal Plan

*[Include within the above processes and responsibilities for:*

- (i) Training of responsible personnel to identify and to categorize Defects discovered during inspection. This shall include training specific to the identification and recording of Category 1 Defects.*
- (ii) Tracking and reporting of Defects including fault detection logs, software output*
- (iii) Generation of corrective action work orders through the MMS including how backlog of corrective maintenance and repair activities will be populated and monitored in the MMS*
- (iv) Action by Defect category type, to include a description of how the actions are carried out stating the responsible individuals and the processes for specific Defect types with examples*
- (v) How Defects will be remedied, with examples provided for all common Defects, stating necessary notification and the individuals to be notified for such Defect remedy.*
- (vi) Documentation including how Defects will be entered, updated and closed in the Maintenance Management System.*
- (vii) Verification of the satisfactory completion of Maintenance Work / Maintenance Services and restoration of asset condition*
- (viii) Discovery of maintenance trends to determine the need for adjustments in the weekly, monthly and annual maintenance plan to address changing project conditions*
- (ix) Inspection and testing of Project items and the identification and classification of Defects and inspection failures.*
- (x) Monitoring instrumentation according to applicable specification*
- (xi) Field inspections of completed Maintenance Work / Maintenance Services and for preparing daily reports to document all inspections performed*
- (xii) Identification of inspection agencies and organizations, including information on each agency's capability to provide the specific services required, certifications held, and equipment*
- (xiii) Preparation and submittal of the Baseline Element Condition Report (BECR) (For Version 1 of the MMP only)*
- (xiv) Hazard mitigation for any Category 1 Defect in a Maintained Element of which the DB Contractor is aware through its own inspections, from a third party or through notification by TxDOT*
- (xv) Proposal to TxDOT of a repair method for any Defect]*

#### **5.4 Tracking and Reporting Noncompliance Events**

Refer to the following procedure in Appendix 13 for Noncompliance Events:

- MMP-025 – Tracking and Reporting Noncompliance Events

*[Include within the above processes and responsibilities for:*

- (i) *Meeting self-reporting obligations*
- (ii) *Identification of the start date of each Noncompliance Event*
- (iii) *Accurate assessment and reporting of the date of cure*
- (iv) *Proper use of the Noncompliance Events database and integration with the MMS.*
- (v) *Validation of the data, times, dates and other information entered into the Noncompliance Event database described in Section 13 of the DBA including frequency of checks / audits]*

## 6. MAINTENANCE SAFETY PLAN

Refer to the following procedure in Appendix 13:

- MMP-027 – Implementation of Safety Plan

The Maintenance Safety Plan describes the DB Contractor's policies, plans, training programs, and work site controls to ensure the health and safety of personnel involved in the Project and the general public affected by the Project during the Maintenance Period. The Maintenance Safety Plan is designed to preserve the safety of Users, adjacent communities, transportation workers and Emergency Services. Coordination with applicable Traffic Management Centers (TMCs) will occur as described in Section 1.2 of the MMP.

The Maintenance Safety Manager complying with the requirements of *Section 1.2.5 of CMA Exhibit 2* is *[Insert name and contact details]*.

*[For Version 2 of the Maintenance Safety Plan, develop the plan based on the Safety and Health Plan in Section 2.4 of the Technical Provisions and tailored specifically to meet the Project's Maintenance Services requirements. Include within the Maintenance Safety Plan processes and responsibilities for:*

- (i) *Transition from safety of Maintenance Work before Substantial Completion to safety of Maintenance Services after Substantial Completion in order to provide continuity and apply lessons learned*
- (iii) *The individual assigned during each shift during the Maintenance Services assigned to ensure compliance with the Maintenance Safety Plan*
- (iv) *Project-specific amendments for any Renewal Work not covered by the existing plan*
- (v) *Notification and recording of safety incidents associated with Maintenance Services including the location, number of vehicles involved, severity of incident, number of lanes affected, and duration of any associated Lane Closure.]*

**7. TRAFFIC MANAGEMENT PLAN**

Refer to the following procedure in Appendix 13:

- MMP-028 –Traffic Collection and Reporting

**7.1 Descriptions, Qualifications, Duties and Responsibilities of Traffic Personnel**

The qualifications and duties of the traffic engineering manager, traffic control coordinator, traffic safety officer, and other personnel with traffic control responsibilities are shown in Table 7.1.

**Table 7.1: Qualifications and Duties of Traffic Personnel for Maintenance Work / Maintenance Services**

Traffic Personnel Title	Required Qualifications	Description of Duties

Refer to Chapter 1 of the MMP for Personnel Training and Certification of patrol staff in health and safety, traffic control, incident management, and identification of Defects.

**7.2 Processes for Lane Closures and Traffic Control Plans**

[For Version 1 of the MMP] The Traffic Management Plan is at *[Chapter X, Section X]* of the PMP.

*[For Version 2 of the MMP, transfer applicable procedures from the PMP and include within the MMP processes and responsibilities for:*

- (i) Obtaining acceptance of detours, road and Lane Closures and other traffic pattern modifications from applicable Governmental Entities, and implementing, maintaining and removing those modifications*
- (ii) Obtaining approval of Lane Closure and traffic control plan from TxDOT;*
- (iii) Installation, maintenance and removal of interim signing and the corresponding handling of permanent signing during maintenance work*
- (iv) Installation, maintenance, replacement and removal of traffic control devices, including pavement markings and traffic barriers, if used*
- (v) Safe ingress and egress of construction vehicles in the work zone;*
- (vi) Continuous access to established truck routes and Hazardous Material (HazMat) routes, and to provide suitable detour routes, including obtaining any approvals required by the appropriate Governmental Entities for these uses. (Refer to section 3.1 Hazardous Material Management Plan of the MMP)*
- (vii) Comprehensive traffic control strategy to be implemented at the work site including an evaluation of the work operation, traffic conditions, safe ingress and egress of construction vehicles*
- (viii) Modification of plans as needed to adapt to changing Project circumstances;*



- (ix) *Communication of TMP information to DB Contractor's public information personnel and notify the public of maintenance of traffic issues; and*
- (x) *Contingency plan of how traffic congestion can be alleviated.]*

Refer to *Section 18.3 of the Technical Provisions* and Exhibit 17 of the Agreement for assessment of Lane Rental Charges during Construction and Exhibit 15 of the CMA for assessment of Lane Rental Charges during the Maintenance Period.

Refer to the following procedure in Appendix 13:

- MMP-029 – Lane Closures and Traffic Control

### **7.3 Public Information and Communications Plan**

Refer to the following procedure in Appendix 13:

- MMP-030 – Implementation of Public Information and Communications Plan

[For Version 1 of the MMP] The Public Information and Communications Plan is in *[Chapter X, Section X]* of the PMP.

*[For Version 2 of the MMP, transfer applicable procedures from the PMP and include within the MMP processes and responsibilities for public information and communications necessary for performance of Maintenance Services. This section may cross reference to the Traffic Management Plan if this contains the necessary processes.]*

## **8. TRANSITION PLAN**

### **8.1 Maintenance Transition Plan**

The Maintenance Transition Plan complies with *Section 4.7 of CMA Exhibit 2* and is designed to coordinate the identification of Maintenance Transition punch list items required to be completed prior to maintenance transfer at the end of the Maintenance Term.

Refer to the following procedure in Appendix 13:

- MMP-032 – Implementation of Transition Plan

*[Include within the MMP processes and responsibilities for:*

- (i) *Training TxDOT employees to have a complete understanding of the infrastructure and the maintenance activities required to maintain adequate performance of highway facility.]*

9. MAINTENANCE QUALITY MANAGEMENT PLAN

9.1 Quality Management Organization

The Maintenance Work /Maintenance Quality Management Plan (MQMP) complies with Section 1.2.2 of CMA Exhibit 2. As shown on Figure 9.1, TxDOT's Quality Assurance Program (QAP) encompasses design, construction and maintenance throughout all phases of delivery.

Figure 9.1: Overview of TxDOT's Quality Assurance Program including Maintenance

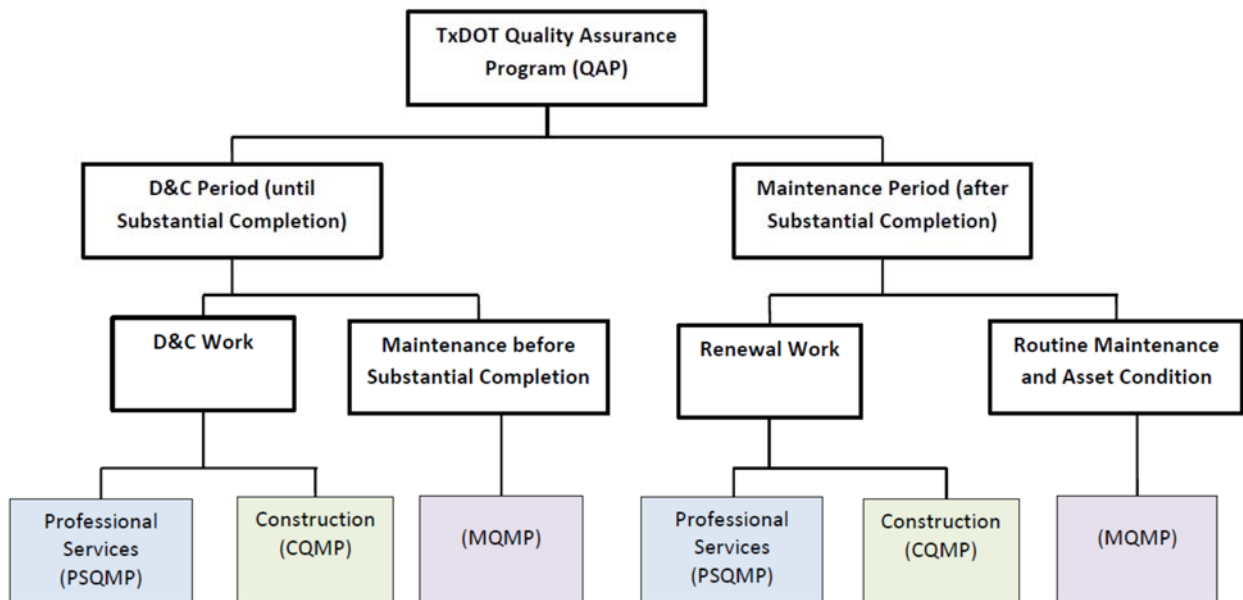

Table 9.1 below shows the maintenance quality management organization and staffing plan showing the period of time that each quality management staff member will be present on the site and the resumes of the Key Personnel.

Table 9.1 Maintenance Quality Management Organization

Name of Person within Maintenance Quality Organization	Start date and period required	Percentage of time allocated to Project	Required experience and qualifications

An organizational chart identifying all quality management personnel, their roles, authorities and line reporting relationships and resumes for all quality management personnel is included in Appendix 16.

A description of the roles and responsibilities of all quality management personnel and those who have the authority to stop activities is included in Appendix 16.

A list of testing agencies, including information on each agency's capability to provide the specific services required for the activities, certifications held, equipment, and location of laboratories is included in Appendix 16.

## **9.2 Quality Policies**

The quality policies and objectives that DB Contractor shall implement throughout its organization are included in Appendix 16. The policies shall demonstrate the DB Contractor senior management's commitment to implement and continually improve the maintenance quality system.

## **9.3 MQMP Processes**

Processes in the MQMP are developed in accordance with the following:

- Objectives, targets and responsibilities are: consistent with TxDOT's Quality Policy and QAP requirements; assigned for each organizational level within DB Contractor organization; clear, specific, measurable and achievable; and a *[Insert name of individual]* is responsible for the measurement and analysis of their achievement.
- Sources of information used to identify opportunities for continuous improvement include: records available on systems such as MMS; customer complaints database; Noncompliance Events database; level of satisfaction of Users; and evidence of lack of effectiveness of existing processes.

Refer to the following procedures in Appendix 13 for the MQMP:

- MQMP-001 – Performance Requirements Compliance
- MQMP-002 – Verification of Records
- MQMP-003 – Records for TxDOT Review

*[Include within the MQMP processes and responsibilities for:*

- (i) How DB Contractor will meet the Performance Requirements, including the necessary inspection procedures and frequencies to ensure compliance with Targets and the achievement of Defect Remedy Period to mitigate hazards, permanently remedy, and permanently repair Defects.*
- (ii) Inspection and test plans, including the timing and frequency of testing*
- (iii) Control of quality records*
- (iv) Validation of the accuracy of Maintenance Records*
- (v) Management reviews*
- (vi) Measurement of customer satisfaction*
- (vii) Control of nonconforming products and services*

- (viii) Validation of the data, times, dates and other information entered into the Maintenance Management System for Noncompliance Events*
- (ix) Verification of DB Contractor's compliance with the Performance Requirements including frequency of checks / audits*
- (x) Accuracy of all Maintenance Records including frequency of checks / audits*
- (xi) Making all quality records immediately available to TxDOT for review]*

The person responsible for updating the MMP is *[Insert the name of the position]*. The TxDOT individuals that will need to be consulted with changes to the MMP are *[Insert names of individuals]*.

Refer to the following procedure in Appendix 13:

- MMP-033 – Updating the MMP Plan

**APPENDIX 1: STAFF REQUIREMENTS TABLE**

*[Insert personnel details for Maintenance Work before Substantial Completion in Version 1, and for Maintenance Services after Substantial Completion in Version 2]*

Key personnel or other personnel position	Number of employees in category	Dates required in connection with Project	% of time to be allocated to Project	Corresponding TxDOT person

**APPENDIX 2: STAFF NAMES CONTACT DETAILS AND QUALIFICATIONS**

*[Insert contact details, qualifications and training record for Maintenance Work before Substantial Completion in Version 1, and for Maintenance Services after Substantial Completion in Version 2]*

Key Personnel or other personnel position	Staff name and start date	Contact details	Education, qualifications and experience	Link to training record in connection with Project
			<i>[Insert details or link to resume]</i>	

**APPENDIX 3: CONTACT DETAILS FOR TXDOT AND THIRD PARTIES**

*[Insert contact details for Maintenance Work before Substantial Completion in Version 1, and for Maintenance Services after Substantial Completion in Version 2]*

Organization	Contact name, e-mail and address	Business Phone
TxDOT <i>[List all TxDOT contacts in connection with Project]</i>		
Governmental Entities <i>[list all Governmental Entities]</i>		
Traffic Management Centers (TMC)		
Utilities <i>[list all utilities]</i>		
<i>[Other third parties]</i>		

**APPENDIX 4: PERMITS FOR GOVERNMENT AGENCIES AND THIRD PARTIES**

<b>Permit Name</b>	<b>Agency/Reason for Permit</b>	<b>Description of Permit</b>	<b>Date of expiry / revision</b>
<i>[List all Permits Required in connection with Project]</i>			

**APPENDIX 5: CONTROLLING MANUALS, GUIDELINES AND SPECIFICATIONS**

*[Insert here a Project-specific list of governing manuals, guidelines and specifications at the Proposal Due Date. Update this list as part of Version 2 of the MMP and thereafter at least annually. ]*

<b>Location in Technical Provisions</b>	<b>Manual, Guideline, or Specification Title</b>	<b>Revision Date of Controlling Version</b>
Section 1, 10, 11, 16	TxDOT's Roadway Design Manual	
Section 2	Texas State Records Retention Schedule	
Section 2	ISO 9001 Quality Management Systems - Requirements	
Section 2	AASHTO R18-10, Establishing and Implementing a Quality System for Construction Materials Testing Laboratories	
Section 2	ISO 17025, General Requirements for the Competence of Testing and Calibration Laboratories	
Section 2	TxDOT's Quality Assurance Program (QAP) for Design-Build (D-B) Projects	
Section 2	TxDOT Contract Administration Handbook for Construction	
Section 2	USACE's Engineering and Design - Hydrographic Surveying (EM 1110-2-1003)	
Section 3	TxDOT Style Guide	
Section 4	ISO 14001 - Environmental management	
Section 4	TxDOT Environmental Manual	
Section 4	Any TxDOT local Storm Water Management requirements	
Section 4, 6, 7, 8, 10, 16	TxDOT's Standard Specifications for Construction and Maintenance of Highways, Streets, and Bridges	
Section 4	Texas Parks and Wildlife Code	

<b>Location in Technical Provisions</b>	<b>Manual, Guideline, or Specification Title</b>	<b>Revision Date of Controlling Version</b>
Section 4	OSHA 1910.120	
Section 6	Utility Accommodation Rules (UAR)	
Section 6	TxDOT ROW Utility Manual	
Section 7	TxDOT Right-of-Way Manual Collection	
Section 7	TxDOT Access Management Manual	
Section 7, 9	TxDOT Survey Manual	
Section 7	TxDOT ROW Appraisal and Review Manual	
Section 7	Manual of Practice by the Texas Society of Professional Land Surveyors	
Section 7	US National Map and Accuracy Standards	
Section 8, 12, 13	TxDOT's Geotechnical Manual	
Section 8	TxDOT's Pavement Design Guide	
Section 8	TxDOT FPS 21 procedure	
Section 8	AASHTO Guide for the Design of Pavement Structures	
Section 8	AASHTO T307	
Section 8	TxDOT Designation: Tex-145-E	
Section 8	TxDOT Guidelines for Treatment of Sulfate-Rich Soils and Bases in Pavement Structures	
Section 8	TxDOT Designation: TEX-121-E	
Section 8	TxDOT Special Specification 2304	
Section 8	TxDOT Designation: TEX-1001-S	
Section 9	General Rules of Procedures and Practices of the Texas Board of Professional Land Surveying	
Section 10	TxDOT's Roadside Design Guide	
Section 11	AASHTO Roadside Design Guide	
Section 11	TxDOT standard CCG-12	
Section 12	TxDOT Hydraulic Design Manual	
Section 12	Local TxDOT District standards	
Section 12	Texas NPDES regulations	
Section 12, 13	FHWA Hydraulic Engineering Circular (HEC)-14, (HEC)-18, HEC-23, and HEC-25	
Section 13	AASHTO LRFD Bridge Design Specifications	

<b>Location in Technical Provisions</b>	<b>Manual, Guideline, or Specification Title</b>	<b>Revision Date of Controlling Version</b>
Section 13, 16	AASHTO Standard Specifications for Structural Supports for Highway Signs, Luminaires, and Traffic Signals	
Section 13	TxDOT Bridge Design Manual – LRFD	
Section 13	TxDOT Bridge Detailing Guide	
Section 13	TxDOT Preferred Practices for Steel Bridge Design, Fabrication, and Erection	
Section 13	AASHTO LRFD Guide Specifications for Design of Pedestrian Bridges	
Section 13	ACI 365.1R Service-Life Prediction–State-of-the-Art Report	
Section 13	PTI Guide Specification, Recommendations for Stay-Cable Design, Testing and Installation	
Section 13	AASHTO Standard Specifications for Highway Bridges	
Section 13	AASHTO Guide Specifications and Commentary for Vessel Collision Design of Highway Bridges	
Section 13	AASHTO T 106, AASHTO T 160	
Section 13	ASTM A709 Grade 50, Grade HPS 50, Grade HPS 70, and Grade HPS 100	
Section 13	ASTM C 827, ASTM A416, ASTM A882	
Section 13	TxDOT Bridge Railing Manual	
Section 13	FHWA NCHRP 350	
Section 13	AASHTO Guide Manual for Bridge Element Inspection	
Section 13, 19	AASHTO's Manual for Bridge Evaluation	
Section 13	TxDOT Bridge Inspection Manual	
Section 13	AASHTO/NSBA Steel Collaboration S10.1 Steel Bridge Erection Guide Specifications	
Section 13	AASHTO/AWS DI.5 Bridge Welding Code	
Section 13	AASHTO Guide Specifications for Design and Construction of Segmental Concrete Bridges	
Section 13	AASHTO's Manual for Condition Evaluation of Bridges.	
Section 13, 16	AASHTO Roadside Design Guide	



<b>Location in Technical Provisions</b>	<b>Manual, Guideline, or Specification Title</b>	<b>Revision Date of Controlling Version</b>
Section 14	American Railway Engineering and Maintenance of Way Association (AREMA) guidelines	
Section 14	AREMA Manual for Railway Engineering and Communications & Signal Manual of Recommended Practices	
Section 14	TxDOT Traffic Operations Manual	
Section 15	TxDOT Type T80HT Traffic Rail Standards	
Section 15	TxDOT Departmental Material Specifications (DMS), Section DMS-8110, Coatings for Concrete	
Section 15	TxDOT DMS, Section DMS-8100 Structural Steel Paints - Formula	
Section 15	TxDOT DMS, Section DMS-8101 Structural Steel Paints - Performance	
Section 15	Joint BNSF/UPRR Guidelines for Railroad Grade Crossing Separations	
Section 15	AASHTO Guide for the Development of Bicycle Facilities	
Section 15, 16	Texas Manual of Uniform Traffic Control and Devices (TMUTCD) for Streets and Highways	
Section 15	Proposed Guidelines for Pedestrian Facilities in the Public Right-of-Way (PROWAG),	
Section 15	Texas Technical Institute's Recommendations, Procedures, and Guidelines for the Protection of Trees and Sensitive Landforms	
Section 16	TxDOT's Standard Highway Sign Designs for Texas	
Section 16, 17, 18	TxDOT's Standard Sheets	
Section 16	TxDOT's Freeway Signing Handbook	
Section 16	AASHTO's A Policy on Geometric Design of Highways and Streets	
Section 16	TxDOT's standards and requirements as specified in TxDOT's Material Producer List	
Section 16	Texas Accessibility Standards (TAS)	
Section 16	TxDOT Special Specification 8835	
Section 16	TxDOT Traffic Signals Manual	
Section 16	TxDOT Highway Illumination Manual	

<b>Location in Technical Provisions</b>	<b>Manual, Guideline, or Specification Title</b>	<b>Revision Date of Controlling Version</b>
Section 16	TxDOT's Accessible Pedestrian Signal (APS) Guidelines	
Section 17	National Transportation Communication for ITS Protocol (NTCIP)	
Section 17	TxDOT ITS Specifications	
Section 18	NCHRP Report 498 – Illumination Guidelines for Nighttime Highway Work	
Section 18	TxDOT's Compliant Work Zone Traffic Control Device List (CWZTCD list)	
Section 19	TXDOT's Pavement Management Information System Rater's Manual	
Section 19	Special Specification 8094 Mobile Retro-reflectivity Data Collection for Pavement Markings	
Section 20	AASHTO Guide for the Planning, Design, and Operation of Pedestrian Facilities	
Section 20	United States Access Board Accessibility Guidelines for Pedestrian Facilities in the Public Right-of-Way	
	<i>[Insert here new manuals, guidelines or specifications applicable to the Maintenance Services.]</i>	

**APPENDIX 6: MAINTENANCE LIMITS AND LIMITS OF PERFORMANCE SECTIONS**

*[Include Schematic drawings that show the Maintenance Limits and the limits of the Performance Sections for before Substantial Completion in accordance with Section 19.2 of the Technical Provisions in Version 1 of the MMP. Include Schematic drawings that show the Maintenance Limits and the limits of the Performance Sections for after Substantial Completion in accordance with CMA Exhibit 2 in Version 2 of the MMP]*

**APPENDIX 7: RENEWAL WORK SUBMITTAL**

*[Include the Renewal Work Submittal (including Renewal Work Schedule) in accordance with [Section 2.5 of CMA Exhibit 2.]*

**APPENDIX 8: MAINTENANCE SERVICES SUBMITTAL SCHEDULE**

*[Include Maintenance Services Submittal Schedule in accordance with Section 3 of CMA Exhibit 2.]*

**APPENDIX 9: PERFORMANCE AND MEASUREMENT TABLES**

*[Insert the latest version of the Performance and Measurement Tables]*

**APPENDIX 10: MAINTENANCE FACILITY LOCATION**

*[Insert a map showing the location of the Maintenance Facility]*

**APPENDIX 11: INSURANCE VERIFICATION AND P&P BONDS**

*[Provide verification of insurance coverage in accordance with [Section 7.7] of the CMA]*

*[Provide Payment and Performance Bonds required for the Maintenance Work / Maintenance Services in accordance with [Section 8.1] of the DBA, [Section 7.4] of the CMA]*

**APPENDIX 12: MAINTENANCE MANAGEMENT SYSTEM DETAILS**

*[Insert the required details of the MMS]*

## APPENDIX 13: MMP PROCEDURES

MMP Mandatory procedures are shown below. *[Add additional procedures as necessary and provide cross references to the applicable section of the MMP]*

MMP Procedure Number	MMP Procedure Name	MMP Section Reference
MMP-001	Submittals and Coordination with TxDOT, Other Agencies and Third Parties	1.2.1, 1.2.2
MMP-002	Agency Coordination for Oversize Loads	1.2.1.2
MMP-003	Quality Control of Subcontractors Activities and Products	1.6
MMP-004	Maintenance of Facilities, Vehicles, and Equipment Plan	1.7
MMP-005	Emergency and Incident Management	2.1
MMP-006	Incident Damage Reports, Third Party Claims and Repairs	2.1
MMP-007	Complaint Review and Response	2.1
MMP-008	Customer Satisfaction Data Collection System	2.1
MMP-009	Snow and Ice Control Plan	2.2
MMP-010	Severe Weather Evacuation Plan	2.2
MMP-011	Hazardous Materials Management Plan	3.1
MMP-012	Implementation of SW3P after Substantial Completion	3.2
MMP-013	Implementation of Spill Prevention and Countermeasures Plan	3.3
MMP-014	Implementation of Pollution Prevention Plan	3.4
MMP-015	Implementation of Waste Management	3.4
MMP-016	Implementation of Recycling Plan	3.4
MMP-017	Processing Driveway, Utility, and Other Permits	3.5
MMP-018	Implementation of Environmental Procedures and Training	3.6
MMP-019	Mitigation Procedures for Impacts to Neighboring Facilities	3.6
MMP-020	Renewal Work	4.2
MMP-021	Establishing Maintenance Management System	5.2
MMP-022	Defect Categorization and Repair	5.3
MMP-023	Maintenance Inspection Plan	5.3
MMP-024	Maintenance Repair Submittal Plan	5.3
MMP-025	Tracking and Reporting Noncompliance Events	5.4
MMP-026	Not Used	
MMP-027	Implementation of Safety Plan	6
MMP-028	Traffic Collection and Reporting	7
MMP-029	Lane Closures and Traffic Control	7.2
MMP-030	Implementation of Public Information & Communications Plan	7.3
MMP-031	Implementation of Close-Out Requirements	8
MMP-032	Implementation of Transition Plan	8
MMP-033	Updating MMP Plan	9.2
MQMP-001	Performance Requirements Compliance	9.2

MQMP-002	Verification of Records	9.2
MQMP-003	Records for TxDOT Review	9.2

**APPENDIX 14: TEMPLATE FOR TYPICAL PROCEDURE**

**1. PURPOSE AND NEED**

*[List the reason for the procedure's implementation.]*

**1.1 Methodologies**

*[List the methodologies to be defined as part of the procedure.]*

**2. SCOPE**

*[Define the limits of the procedure. Define individuals or workgroups to whom the procedure applies. ]*

**3. DEFINED TERMS**

- *[List the terms defined as part of the procedure]*

**4. STEPS IN PROCEDURE**

*[Describe the procedure, in detail. List all steps. Assign individual responsibility for implementing the procedure]*

*[Include tables, flowcharts and figures as applicable.]*

**5. DOCUMENT CONTROL**

*[List the methods by which the procedure will be documented and archived. Define the location at which the procedure's records will be filed.]*

**REFERENCES**

*[Reference applicable documents within the contract with specific section and page locations.]*

**Approved By:**

\_\_\_\_\_  
**FirstName LastName**  
**Maintenance Manager (MM)**

\_\_\_\_\_  
**Date**

\_\_\_\_\_  
FirstName LastName

Procedure Owner

\_\_\_\_\_  
Date

**RECORD OF REVISIONS**

<b>Rev.</b>	<b>Date Issued</b>	<b>Pages Affected</b>	<b>Comments</b>
0	<i>XX/XX/XXXX</i>	<i>All</i>	<i>Initial Issue</i>
1	<i>XX/XX/XXXX</i>	<i>XX-XX</i>	<i>Add brief comment regarding revision</i>

**APPENDIX 15: FORMS FOR MAINTENANCE PROCEDURES**

*[Where maintenance procedures listed in Appendix 13 require separate forms, include on table below. The form number shall directly relate to the procedure number. Change and complete as needed and provide references to Section of the MMP.]*

<u>MMP Form Number</u>	<u>MMP Form Name</u>
	Trip Inspection Form
	Equipment Inspection Form
	Purchase Order Form
	Daily Roadway Inspection Form
	Monthly Roadway Inspection Form
	Lighting Inspection form
	Repair Log for Inspections
	Incident Report Form
	Incident Call Log
	Training Attendance Form
	<i>[Add additional forms as required]</i>

**APPENDIX 16: QUALITY POLICIES AND PROCEDURES**

*[Insert here the quality policies and procedures applicable to the Maintenance Work / Maintenance Services]*

Texas Department of Transportation  
Technical Provisions  
for  
SH 249 Extension

Attachment 21-1  
Toll Systems Responsibility Matrix

February 9, 2017



**Attachment 21-1**  
**Toll Systems Responsibility Matrix**

LEGEND		Work Description		
Primary Responsibility	A	1	2	3
Support Responsibility	B	Design	Procure	Install and/or Construct
Coordination Responsibility Only	C			
No Responsibility	D			

Element/Task/Component/ Sub-system	TxDOT (TOD Design) (T)			DB Contractor			Systems Integrator (SI)			Comments Other Responsibility/Information
	1	2	3	1	2	3	1	2	3	
<b>FACILITIES</b>										
Toll plaza design layout	A	N/A	N/A	B	N/A	N/A	B	N/A	N/A	See Sec 21.3 of TPs
Metered power service to roadside equipment / controller cabinet	B	D	C	A	A	A	B	D	C	SI to provide power requirements and special requirements for DB Contractor to construct utilities near toll collection points.
Electrical conductors from equipment pad to Toll Zone equipment	C	D	C	C	D	C	A	A	A	DB Contractor will coordinate access to roadway for installations.
Complete backup power systems: generators, automatic transfer switches, and fuel tanks	C	D	C	D	D	C	A	A	A	DB Contractor will coordinate access to roadway for installations
Concrete pad/foundation and conduits for backup power systems	A	D	C	D	D	C	B	A	A	T to design for SI. DB Contractor to construct grading, earthwork and subgrade for SI work. DB Contractor will coordinate access to roadway for installations
Uninterruptible power supplies for the lane controllers/tolling equipment at Toll Zones	C	D	C	D	D	C	A	A	A	DB Contractor will coordinate access to roadway for installations

**Attachment 21-1**  
**Toll Systems Responsibility Matrix**

LEGEND		Work Description		
Primary Responsibility	A	1	2	3
Support Responsibility	B	Design	Procure	Install and/or Construct
Coordination Responsibility Only	C			
No Responsibility	D			

Element/Task/Component/ Sub-system	TxDOT (TOD Design) (T)			DB Contractor			Systems Integrator (SI)			Comments Other Responsibility/Information
	1	2	3	1	2	3	1	2	3	
<b>FACILITIES</b>										
Lightning protection & grounding	A	D	C	D	D	C	B	A	A	DB Contractor will coordinate access to roadway for installations. DB Contractor to coordinate with SI for SI placement of conduit prior to DB Contractor placing pavement.
Concrete encased duct bank for dedicated toll fiber	C	D	C	A	A	A	C	D	C	DB Contractor to install conduit in concrete encased duct bank complete with pull strings
Fiber optic cables in conduit and concrete encased duct bank for toll systems	B	D	C	A	A	A	B	D	C	DB Contractor to provide fiber with 4 strands single mode dedicated fiber to each toll zone (E.g. 24 toll zones would require 96 fiber strands) No daisy chaining. DB Contractor to install pull strings, fiber optic markers, test stations and tracer wire with fiber optic cables
Termination cabinet and fiber optic data/communication to termination cabinet	B	D	C	A	A	A	B	D	C	SI to provide communication/data requirements. DB Contractor to provide and test fiber to DB Contractor provided fiber termination cabinets adjacent to each toll zone equipment cabinet pad.

**Attachment 21-1**  
**Toll Systems Responsibility Matrix**

LEGEND		Work Description		
Primary Responsibility	A	1	2	3
Support Responsibility	B	Design	Procure	Install and/or Construct
Coordination Responsibility Only	C			
No Responsibility	D			

Element/Task/Component/ Sub-system	TxDOT (TOD Design) (T)			DB Contractor			Systems Integrator (SI)			Comments Other Responsibility/Information
	1	2	3	1	2	3	1	2	3	
<b>FACILITIES</b>										
Data/communication wire/fiber from termination cabinet to toll systems equipment	C	D	C	C	D	C	A	A	A	SI to install from roadside termination cabinet to toll systems equipment.
Toll Zone pavement and structure, using special pavement section and conduit stub ups for pavement sensors (see Attachment 21-3 of Technical Provisions)	B	D	C	A	A	A	B	D	C	SI to provide pavement loop details with stub-up locations. T will coordinate with DB Contractor for joint layouts. DB Contractor to construct Stub Ups to terminate in junction boxes, provided by DB Contractor, adjacent to toll zone pavement
Loop conduit from junction box to roadside equipment cabinet	A	D	C	D	D	C	B	A	A	DB Contractor will coordinate access to roadway for installations
Gantry equipment conduit from roadside equipment cabinet to toll systems equipment	A	D	C	D	D	C	B	A	A	DB Contractor will coordinate access to roadway for installations
Pavement sensors	A	D	C	D	D	C	B	A	A	DB Contractor to provide access to SI to saw cut and install pavement sensors
Gantries and foundations (includes columns and trusses)	A	D	C	D	D	C	B	A	A	T to design and SI to construct. DB Contractor to provide access for T geotechnical borings and SI construction.
Toll equipment mounts on gantries	C	D	C	D	D	C	A	A	A	SI to install any required equipment mounts on gantries. SI to coordinate with T during the design phase to incorporate any required framing to support equipment mounts.

**Attachment 21-1**  
**Toll Systems Responsibility Matrix**

LEGEND		Work Description		
Primary Responsibility	A	1	2	3
Support Responsibility	B	Design	Procure	Install and/or Construct
Coordination Responsibility Only	C			
No Responsibility	D			

Element/Task/Component/ Sub-system	TxDOT (TOD Design) (T)			DB Contractor			Systems Integrator (SI)			Comments Other Responsibility/Information
	1	2	3	1	2	3	1	2	3	
<b>FACILITIES</b>										
Concrete traffic barrier and foundation, MBGF, barrier end treatments, Toll Zone drainage, grading/earthwork, SW3P and retaining walls within Toll Zone	C	D	D	A	A	A	C	D	C	All reinforcement (barrier, pavement, etc.) within the Toll Zone shall be epoxy coated.
Roadside equipment cabinet concrete pads/foundations	A	D	C	D	D	C	B	A	A	T to design for SI to construct. DB Contractor to provide grading, earthwork and subgrade for SI's slabs. DB Contractor to provide SI access for construction.
Toll Zone maintenance driveways	A	D	C	B	B	B	C	A	A	T to design for SI to construct maintenance driveway pavement surface. DB Contractor to construct grading, earthwork, flexible base, and subgrade for SI work.
Roadside equipment cabinets (incl power, comm and HVAC systems)	C	D	C	D	D	C	A	A	A	SI to install complete. DB Contractor will coordinate access to roadway for installations.
Toll rate signage (Toll rate signs and Toll entrance signs)	A	D	C	B	D	C	C	A	A	DB Contractor will coordinate access to roadway for installations and provide finished grades at each sign location.

**Attachment 21-1**  
**Toll Systems Responsibility Matrix**

<b>LEGEND</b>		<b>Work Description</b>		
Primary Responsibility	A	1	2	3
Support Responsibility	B	Design	Procure	Install and/or Construct
Coordination Responsibility Only	C			
No Responsibility	D			

Element/Task/Component/ Sub-system	TxDOT (TOD Design) (T)			DB Contractor			System Integrator (SI)			Comments Other Responsibility/Information
	1	2	3	1	2	3	1	2	3	
<b>ELECTRONIC TOLL COLLECTION SUB-SYSTEMS (ETC)</b>										
Automatic Vehicle Classification System and Image Capturing System (ICS) Hardware	C	D	C	D	D	C	A	A	A	DB Contractor will coordinate access to roadway for installations.
Computer rack system, routers, hubs, switches, firewalls, VPN, modems, patch/distribution panels,	C	D	C	D	D	C	A	A	A	DB Contractor will coordinate access to roadway for installations.
Toll plaza host computer	C	D	C	D	D	D	A	A	A	
Lane controller hardware	C	D	C	D	D	C	A	A	A	DB Contractor will coordinate access to roadway for installations on DB Contractor provided structures.
Communication equipment	C	D	C	D	D	C	A	A	A	DB Contractor will coordinate access to roadway for installations.
Support equipment at TxDOT designated customer service center	C	D	C	D	D	D	A	A	A	
Commissioning and site acceptance testing	C	D	B	D	D	C	A	A	A	DB Contractor will coordinate access to roadway for testing.
Lane controller software	C	D	C	D	D	D	A	A	A	
Plaza computer software	C	D	C	D	D	D	A	A	A	
Host computer software	C	D	C	D	D	D	A	A	A	
Toll collection system application software	C	D	C	D	D	D	A	A	A	
Maintenance Online Management System Software	C	D	C	D	D	D	A	A	A	
Operational test	C	D	B	D	D	D	A	A	A	
Training: (user and maintenance)	C	D	C	D	D	D	A	A	A	

**Attachment 21-1**  
**Toll Systems Responsibility Matrix**

LEGEND		Work Description		
Primary Responsibility	A	1	2	3
Support Responsibility	B	Design	Procure	Install and/or Construct
Coordination Responsibility Only	C			
No Responsibility	D			

Element/Task/Component/ Sub-system	TxDOT (TOD Design) (T)			DB Contractor			System Integrator (SI)			Comments Other Responsibility/Information
	1	2	3	1	2	3	1	2	3	
<b>ELECTRONIC TOLL COLLECTION SUB-SYSTEMS (ETC)</b>										
Documentation: (user and maintenance)	C	D	C	D	D	D	A	A	A	
Documentation: ETS installation/electrical design and plans	C	D	C	D	D	D	A	A	A	
Documentation: civil as-built drawings, and contact closeout documents	C	D	C	D	D	D	A	A	A	
Documentation: ETS as-built drawings	C	D	C	D	D	D	A	A	A	
FCC licenses/regulations as applies to toll systems	C	D	C	D	D	D	A	A	A	

Texas Department of Transportation  
Technical Provisions  
for  
SH 249 Extension

Attachment 21-2  
Typical Toll Zone Layout

February 9, 2016

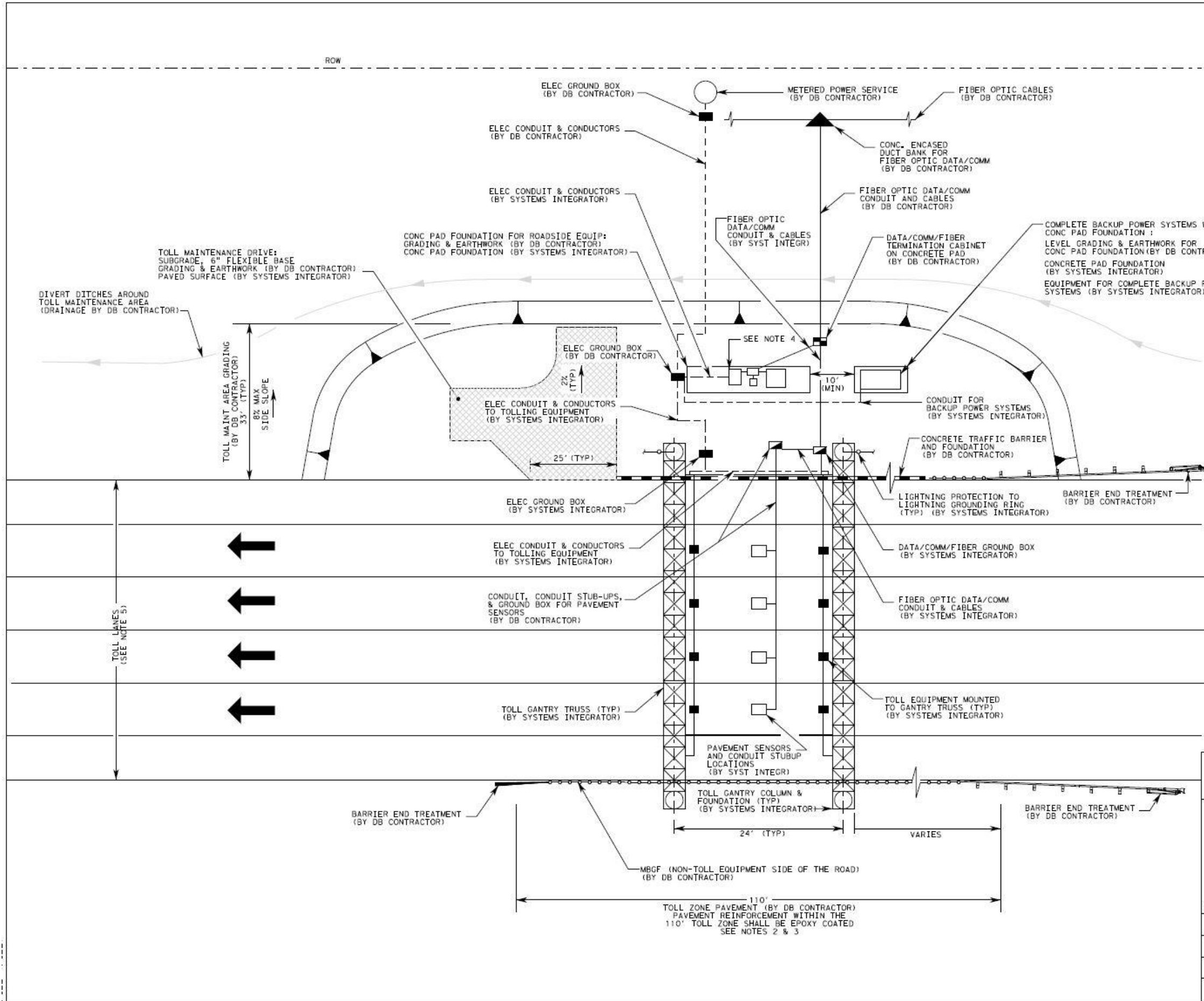

NOT TO SCALE

**LEGEND**

- ▭ PAVED MAINT DRWY
- ELEC GROUND BOX
- ▣ DATA/COMM/FIBER GROUND BOX
- ▤ DATA/COMM/FIBER TERMINATION CABINET
- ELEC CONDUIT & CONDUCTORS (BY DB CONTRACTOR)
- ELEC CONDUIT & CONDUCTORS (BY SYSTEMS INTEGRATOR)
- METERED POWER SERVICE
- PAVEMENT SENSOR
- ▲ DUCT BANK FOR FIBER OPTIC DATA/COMM
- FIBER OPTIC DATA/COMM CONDUIT & CABLES

**NOTES:**

1. MINIMUM 10' BUFFER REQUIRED BETWEEN ROADSIDE TOLL EQUIPMENT CONC PAD FOUNDATION AND BACKUP POWER SYSTEMS CONC PAD FOUNDATION.
2. TOLLING PAVEMENT WITHIN THE DIMENSIONED LENGTH SHALL CONFORM TO REQUIREMENTS SHOWN IN THE "TOLL ZONE PAVEMENT DETAILS".
3. ALL REINFORCEMENT WITHIN THE 110' TOLL ZONE SHALL BE EPOXY COATED (e.g. BARRIER, MISC CONC, PAVEMENT, ETC).
4. ROADSIDE EQUIPMENT CABINETS (POWER, COMM, HVAC) TO BE PLACED BY SYSTEMS INTEGRATOR.
5. REFER TO TECHNICAL PROVISIONS FOR ROADWAY GEOMETRY & LANE CONFIGURATION.

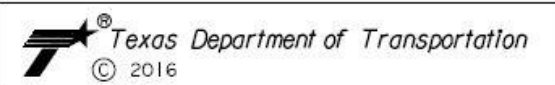

**SH 249 EXTENSION**  
**TYPICAL**  
**TOLL ZONE LAYOUT**

NOT TO SCALE SHEET 1 OF 1

DESIGN	FED. RD. DIV. NO.	STATE PROJECT NO.		HIGHWAY NO.
GRAPHICS				SH 249
CHECK	TX	HOU		SHEET NO.
CHECK	CONTROL	SECTION	JOB	



Texas Department of Transportation  
Technical Provisions  
for  
SH 249 Extension

Attachment 21-3  
Toll Zone Pavement Design

February 9, 2016

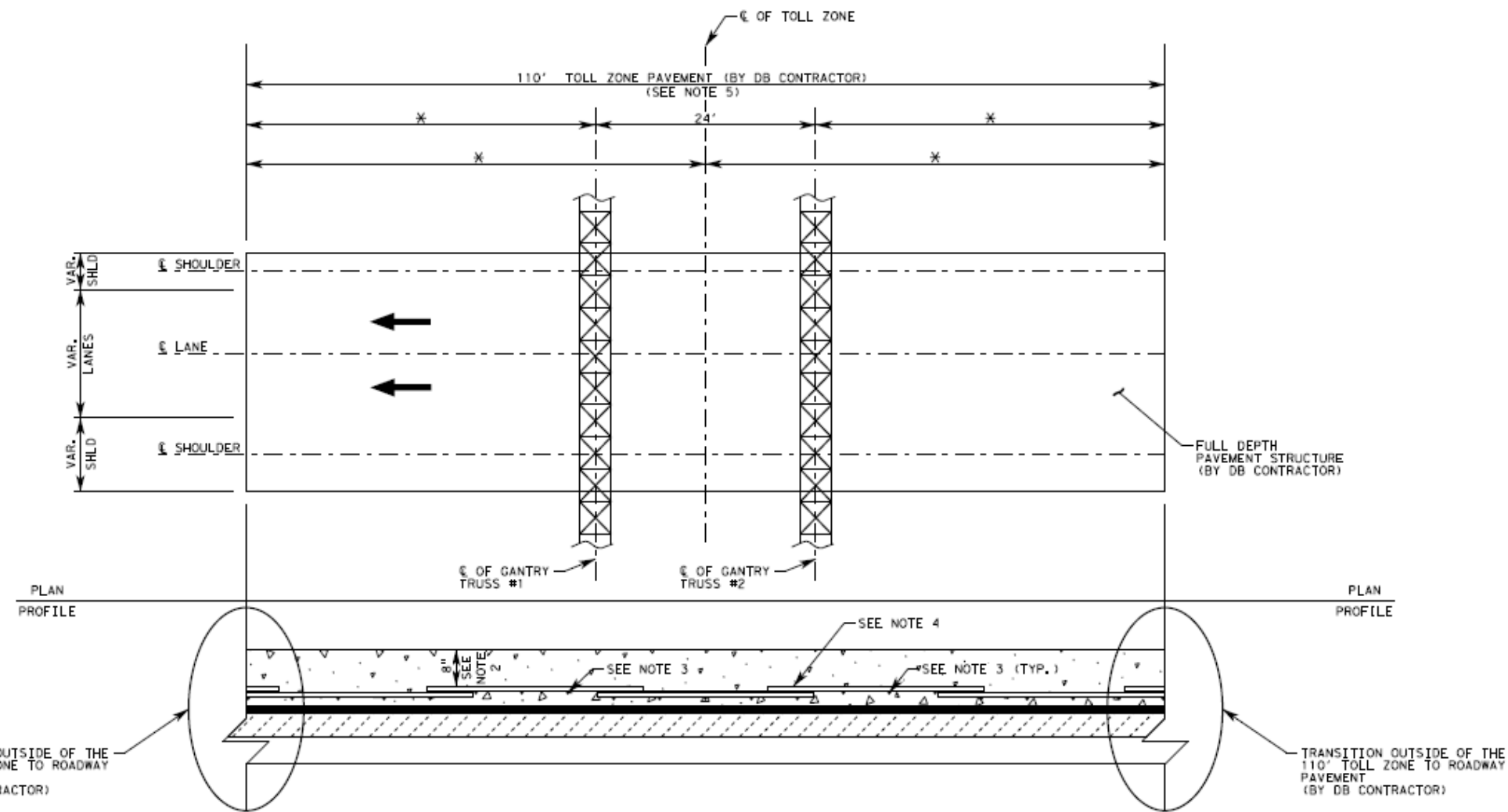

NOTES:

1. FINAL TOLL ZONE PAVEMENT DESIGN SHALL BE THE RESPONSIBILITY OF THE DB CONTRACTOR. DETAILS AND DIMENSIONS PROVIDED ON THIS SHEET ARE MINIMUM REQUIREMENTS FOR THE SYSTEMS INTEGRATOR AND SHALL BE INCORPORATED INTO THE DB CONTRACTOR'S PAVEMENT DESIGN.
2. 8" IS MEASURED FROM TOP OF PAVEMENT TO TOP OF STEEL.
3. ALL TOLL ZONE PAVEMENT SHALL BE CONCRETE AND THE REINFORCING STEEL SHALL BE EPOXY COATED (CONTINUOUSLY REINFORCED CONCRETE PAVEMENT, CRCP).  
  
WHEN CONCRETE PAVING IS USED IMMEDIATELY OUTSIDE THE TOLL ZONE PAVEMENT LIMITS, THE TOLL ZONE CONCRETE TYPE AND REINFORCING STEEL SIZE ARE TO MATCH EXISTING OR PROPOSED CONCRETE PAVEMENT. WHEN ASPHALTIC CONCRETE PAVING (ACP) IS USED IMMEDIATELY OUTSIDE THE TOLL ZONE PAVEMENT LIMITS, THE DB CONTRACTOR SHALL DESIGN AN APPROPRIATE TRANSITION AND SUBSTRUCTURE BETWEEN TOLL ZONE CONCRETE AND ACP.
4. A MINIMUM OF 2/3 OF SPLICES SHALL BE OFFSET FROM ADJACENT SPLICES. THIS OFFSET SHOULD BE A MINIMUM OF 2'.
5. NO CONSTRUCTION JOINTS ARE ALLOWED WITHIN THE 110' TOLL ZONE PAVEMENT AREA. LONGITUDINAL AND TRANSVERSE EXPANSION JOINTS ARE ONLY ALLOWED PER JOINT AND STUBUP DETAIL SHEETS THAT ARE TO BE PROVIDED BY TXDOT AND THE SYSTEMS INTEGRATOR.
6. ALL ACCESSORIES SUCH AS TIES, BAR CHAIRS, SUPPORTS OR CLIPS SHALL BE NON-FERROUS, PLASTIC, PRECAST MORTAR OR CONCRETE BLOCK SUPPORTS OR AS APPROVED BY TXDOT'S FIELD ENGINEER WITH CONCURRENCE BY TXDOT'S TOLLING OPERATIONS DIVISION (TOD).

N. T. S.

\* DIMENSIONS TO BE PROVIDED BY SYSTEMS INTEGRATOR

**LEGEND**

- PROPOSED CONC PVMT (CRCP)
- PAVEMENT STRUCTURE
- PAVEMENT STRUCTURE
- PAVEMENT STRUCTURE
- DIRECTION OF TRAFFIC

© 2016

**Texas Department of Transportation**

**SH 249 EXTENSION**  
**TOLL ZONE PAVEMENT DETAILS**

SHEET 1 OF 1

DESIGN	FED. RD. DIV. NO.	STATE PROJECT NO.		HIGHWAY NO.
GRAPHICS	STATE	DISTRICT	COUNTY	SH 249
CHECK	TX	HOU		SHEET NO.
CHECK	CONTROL	SECTION	JOB	